



SEPARATION METHODS TECHNOLOGIES, INC.



SAM™

**Total Coverage Technology
For Ultra-Stable
and Super-Rugged
HPLC Columns**

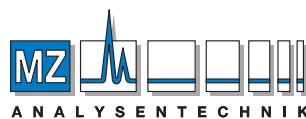

AUTHORIZED DISTRIBUTOR

MZ-Analystechnik GmbH
Barcelona-Allee 17 • D-55129 Mainz
Tel +49 6131 880 96-0
Fax +49 6131 880 96-20
e-mail: info@mz-at.de
www.mz-at.de

**PRODUCTS for
CHROMATOGRAPHIC APPLICATIONS
BIOTECHNOLOGY & MATERIALS ENGINEERING**

Catalog #000314

Letter from the Director of Research of SMT, Inc.

Dear Colleague:

We are pleased to announce SMT's Twentieth year anniversary in service to the scientific community. During this period, we have enjoyed rapid growth and acceptance of our column packing materials, specialty columns as well as our unique solutions for treatment of glass and optical fibers. We have, over the period, substantially expanded our product line, service capability and technical support to meet the growing needs of our customers world-wide.

Our growth has been undoubtedly driven by the confidence in SMT's expertise and the uniqueness of bonding techniques that the company has brought into the chromatographic world. Much of the examples laid by SMT in bonding chemistries has forced many competitors to go back to their drawing tables and work on better ways of chemical bonding on substrates. As a result of these efforts, chromatographic world has enjoyed tremendous growth in column stability over the past two decades! We shall continue to work to earn your trust with our products and with the highest quality of technical support. Remember, our goal since 1993, is to provide you with separation alternatives; we hope to serve you for many years to come! For those of you new to SMT, let me highlight a few aspects of our business approach that exemplifies us from the other manufacturers:

Innovation: For twenty years, SMT has repeatedly led the industry to new standards of measuring performance expected of UHPLC, HPLC and LPLC columns as well as the column packing materials. Our Total Coverage™ bonding scheme has forced many competitors to come up with all kinds of new products that can only mimic. This is exactly why experts in chromatography turn to SMT for their toughest separation problems.

Reproducibility: We are Original Equipment Manufacturer (OEM), and as such, have a complete control over quality and ensuring reproducibility of your chromatography. As an OEM, we utilize proven procedures at every stage of manufacture to guarantee consistency in our silica purity, pore size, particle size, as well as chemical bonding.

Reliability: SMT's policy has been to never change any product that has an existing customer base; however, when improvements are made, an entirely new SMT product line is introduced. Thus a method developed on any of our products can be retained for very long time.

Product Range: We have introduced over 100 stationary phases that have resulted in over 1,000 products for HPLC, MPLC and LPLC. We offer you products that will match or exceed your expectation of high performance with virtually any HPLC application, from small molecules to large proteins, at microbore separation or production scale.

Technical Support: Our technical support representatives bring years of experience directly to your laboratory, significantly reducing cost of method developments.

Worldwide Capability: SMT has a worldwide distribution network with products available all over United States, Canada, France, Germany, England, Asia, and Africa. SMT delivers the same high quality products throughout the world.

We are constantly expanding our product line and would appreciate your comments and suggestions. Please feel free at anytime to suggest how we can improve our products or technical support and meet your needs. You may call me directly at SMT; I will be delighted to take your call. Finally, let me take this opportunity to thank you all for your ongoing support and confidence in SMT.



A handwritten signature in black ink that reads "Hafeez O. D. Fatunmbi, Ph.D." The signature is written in a cursive style.

Hafeez O. D. Fatunmbi, Ph.D.
Director of Research
Separation Methods Technologies, Incorporated

Table of Contents

Introduction	4	SMT-C12 Columns and Applications	49
Ordering Information	5	SMT-C30 Columns and Applications	50
Reversed-Phase Chromatography	6	SMT-Urea Columns and Applications	51
SAM in Separation Science	7	SMT-C6F5 Columns and Applications	52
Introduction to SMT SAM-Columns	8	SMT-MetalSep Columns and Applications	53
SMT SAM-C18 Columns	11	Affinity Chromatography	54
SMT SAM-C8 Columns	18	SMT CIB-Columns and Applications	
SMT SAM-MEB Columns	25	SMT CIB-ProtA Columns and Applications	54
SMT SAM-Phenyl Columns	29	SMT CIB-IgG Columns and Applications	55
SMT SAM-PhenylH Columns	30	SMT CIB-Ovomucoid Columns and Applications	55
Normal Phase Chromatography	31	SMT-Chiral Columns	56
SMT-Silica Columns	32	SMT-ChiralSep1 Columns and Applications	56
SMT SAM-Diol Columns	33	SMT-ChiralSep2 Columns and Applications	57
SMT SAM-Aminopropyl Columns	34	SMT GPC Columns and Applications	58
SMT SAM-Cyanopropyl Columns	35	USP-Designation and SMT-Columns	59
Ion-Exchange Chromatography	36	SMT-Micro & Narrow Bore Columns	60
SMT-SAX Columns	37	SMT-UHPLC Columns	61
SMT-WAX Columns	38	SMT-Guard Columns	62
SMT-DEAE Columns	39	SMT Semi-Prep Columns	63
SMT-SCX Columns	40	SMT Prep & Process Columns	64
SMT-WCX Columns	41	SMT Bulk Packing for Scale-up	65
SMT Specialty Columns	42	SMT Bulk Packing for Bio & Nanotech	66
SMT-PAH Columns and Applications	43	SMT Bulk Packing for Other Applications	67
SMT-TNT Columns and Applications	44	SMT-InnovSep SPE Cartridges	68
SMT-OD-AQ Columns and Applications	45	Specialty Products for Materials Engineering	69
SMT-C3 Columns	46	HPLC Column Selection Guide	70
SMT-C5 Columns	47	References	71
SMT-C6 Columns	48		

Introduction

Separation Methods Technologies, Incorporated (SMT, Inc.) is a surface chemistry research corporation with a goal of providing chromatographers with outstanding column packing materials and specialty columns for various separation chemistries ranging from analytical to process scale. Our primary focus is on the creation of well organized functional molecules on substrate surfaces for various functions including chromatographic applications, bio and nanotechnology as well as materials engineering. SMT Inc. was founded in 1993. The company has its corporate headquarters in Newark, Delaware, with worldwide distribution network.

SMT utilizes patented and proprietary bonding technologies that result in bonded phase coverages that approach 100%. The phases are generally prepared using a technique of Self-Assembled Monolayer (SAM). SMT's methods of bonding allow the density of the functional ligands to be controlled with appropriate spacer molecules, a novel procedure that ensures TOTAL COVERAGE™ and highly

cross-linked polysiloxane underlayer structure. The results are bonded phases that are well protected and that show unprecedented resistance to both acid and base hydrolysis. SAM technology provides the widest range of column retention selectivities and performance benefits to chromatographers.

Since its founding in 1993, SMT column products and packing materials have become a portion of many analytical method developments in major pharmaceuticals and research institutions in the United States of America and all around the world. Over the years, the company has introduced new products for applications in bio and nanotechnologies. SMT specialty products for materials engineering have found applications in the treatment of glass surfaces and reduction of optical fiber breakage as well as other products used in telecommunication industries. Current applications of these products are found in major scientific journals and the application notes cited in this catalog.

Separation Methods Technologies' 10,000 square foot headquarters in Newark, DE



Providing you with separation alternatives since 1993

Ordering Information

SMT Guarantees

SMT, Inc. guarantees that all its products including columns and packing materials will reach you in perfect conditions, or a replacement will be made immediately. Please refer to our return policy.

Specialty Products

All specialty products are prepared to order. The columns packing materials, and other products described in this catalog represent only a collection of products commonly used for chromatographic applications. However, SMT can work with you in developing a specialty product for special or new applications. New products that are not described here can often be prepared by simple adaptations of our already developed technology. And, as such, specialty products may require little or no additional cost. Please call for information regarding feasibility, pricing, and ordering procedures for specialty products.

Quantity Discounts

SMT offers discounts for large quantities and purchase agreements on all products. Please call SMT's sales department for information regarding discounts on bulk purchases.

How To Order

Call our Phone number using:
302-368-0610

Fax in your order using:
302-368-0282

E-mail using:
Sales@separationmethods.com

Mail in your order using:
SMT, Inc.,
Sales Department
31 Blue Hen Drive,
Newark, DE 19713, USA

Online orders are available via our website at:

www.separationmethods.com

When you order, be sure to include: your purchase order number, billing and shipping address, our catalog number and product description and your name and telephone number. All major credit cards are accepted.

Sales Terms & Conditions

Terms of Payment: Net 30 days, FOB Newark, Delaware. Postage and Handling are prepaid and added to the invoice. Product prices are subject to change without notice

Return Policy

No returns will be accepted without prior authorization. Please call for return authorization number and forwarding instructions to prevent delays in refund. All claims must be made within 30 days of shipping.



Reversed-Phase Chromatography

The use of high performance liquid chromatography (HPLC) for the separation and purification of organic compounds including pharmaceuticals, natural products, food additives, organic chemicals and biologicals, has increased dramatically in the past three decades. This increase is undoubtedly associated with the dramatic improvement in bonding chemistry.

When chromatographic separation is done in a reversed-phase mode, the surface chemistry of the stationary (or bonded) phase has a nonpolar characteristic. The mobile phase is generally polar and the polarity can be achieved by variation of one or more polar organic solvents (such as methanol and acetonitrile) with water. Furthermore, the ability to vary the nonpolar characteristic of the stationary phase provides ground for flexibility and the continuous growth of interest in separation using reversed-phase mode. For example, SMT offers many stationary phases with mixed-mode features. In fact, the limiting factor in reversed phase chromatography now depends on the characteristics of the stationary phases procurable. Thus, future advancement in separation science will be governed by the amount of efforts expended on surface modification and materials engineering.

HPLC Method Development

- Choosing a column

The column of choice for analytical methods development is very easy; the best column for an application is simply the column that gives the highest performance under the most favorable condition desired by the end-user. Most analytes are acidic, basic or neutral. The best initial approach is to use a mid-range pH, such as pH 7. The standard SMT SAM-C18 and SAM-C8 columns are the best choice for use at this pH because they provide superior column lifetime, extremely high selectivity and resolution. Acetonitrile or methanol and water are normally the first choice for mobile phase. Another option is combination of organic solvent with phosphate buffer (with buffer range pH 6.2-8.2) or acetate buffer (with buffer range pH 3.8-5.8). Method development optimization can continue from here by changing several factors, including mobile phase, pH, column temperature (up to 95°C). SMT SAM-C18 is uniquely stable at high temperatures, a characteristic that can be used as an additional tool to improve resolution of thermally stable compounds or analytes.

Using a low pH mobile phase results in the best peak shapes for basic compounds because these analytes are fully protonated and exhibit low retention and tailing at this pH. SMT SAM C18 or SAM-C8 columns are the best choice providing longest available lifetime and performance at low pH.

Separations at high pH region may be the most appropriate for certain compounds. For example, it may be possible to separate bases in their free form-where they are not charged. Here the retention increases as the chance of obtaining the desired selectivity improves. SMT SAM-C18 column has the highest ligand density available and offers the best protection (up to pH 12) of the silica substrate from being dissolved by the strongly basic mobile phase. SMT SAM-C18 columns will generally outlast competitors columns of equivalent carbon load at high and low pH conditions.

SMT SAM-C18 vs Competitors

Simple Test Probes

Solutes: 1=Uracil
2=Benzene
3=Hexanophenone
4=Anthracene
Eluent: ACN: Water 70:30 (v:v)
Flow: 1.0 mL/min
Detector: UV; 254nm
Temp: 30°C

SAM-C18 column selectivities and performances are generally similar for most simple analytes

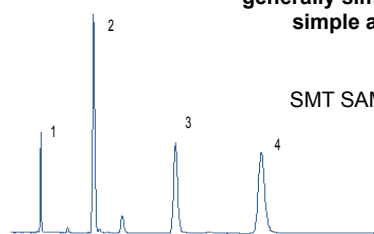

SMT SAM-C18

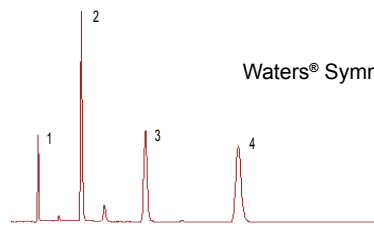

Waters® Symmetry-C18

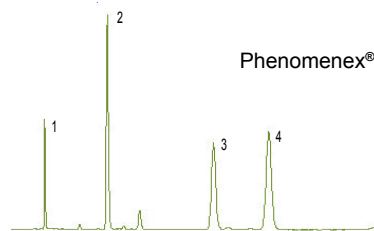

Phenomenex® Luna-C18

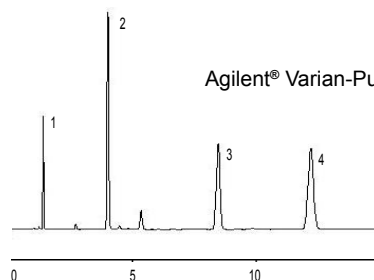

Agilent® Varian-Pursuit XR-C18

Self-Assembled Monolayers (SAM) in Separation Science

Self-Assembled Monolayers (SAM) are supramolecular organizes resembling, in some respects, the well-known Langmuir-Blodgett (LB) built-up films while displaying other distinct and rather Special features¹⁻⁵. Much of the interest in SAM stems from their potential in wide range of scientific and technological applications⁴. The first application of SAM in chromatographic separation science was developed at the University of Delaware by Fatunmbi and Wirth¹⁻³. The bonding technique allows ordered monolayers of functional molecules to be chemically immobilized on solid substrates, such as, silica and alumina. The technique of bonding was termed “horizontal polymerization” due to the fact that there is significant Si-O-Si bridging parallel to the silica substrate. This is achieved by reaction of trifunctional silanizing agent with the silica substrate under anhydrous condition, except for a monolayer of water on silica. This contrasts with conventional polymerization of trifunctional silanes, referred to as “vertical polymerization,” where water is deliberately added to polymerize the reagents before attachment to the surface. The key structural difference here is that horizontal polymerization provides much higher ligand density at the silica surface boundary.

The bonding chemistry utilized for chromatographic applications results in a monolayer coverage with typical thickness in the range of 6-22 Å, depending on the length of the attached ligand. For example, when a C18 ligand is attached, a film thickness of about 22 Å is obtained. Thickness in this range ensures bonding of the ligand both in and around the substrate material without blocking of the pores. Results from the relaxation time measurements, using solid state nuclear magnetic resonance spectroscopy (NMR)^{3,4}, showed that the spacer molecules are evenly dispersed within the functional ligand and are not clumped together.

SMT columns for reversed-phase chromatography include SMT-C18, SMT-C8, SMT-Elite C18, SMT-Elite C8, SMT-ODL, SMT-OL, SMT-MEB (including C1, C2, and C4), SMT-C30, SMT-C6, SMT-C12, SMT-C3, SMT-C5, SMT-Phenyl, SMT-ODAQ, SMT-OAQ, SMT-Urea, SMT-ChiralSep, SMT-CIB and other mixed phases.

SMT offers many other columns for ion exchange chromatography including SMT-SAX, SMT-WAX, SMT-SCX, SMT-WCX, SMT-DEAE, SMT-MetalSep. Unlike polymer-based counterparts, these columns are silica-based and are mechanically stable at high chromatographic pressures

SMT offers packing materials for large-scale purification and Solid Phase Extraction (SPE) processes. Essentially all SMT analytical column packing materials are offered in large particle sizes at significantly reduced prices for process scale column packings and low pressure bulk purifications. Please refer to our bulk packing materials for these products.

SMT SAM vs Competitors

SAM-C18 Total Coverage

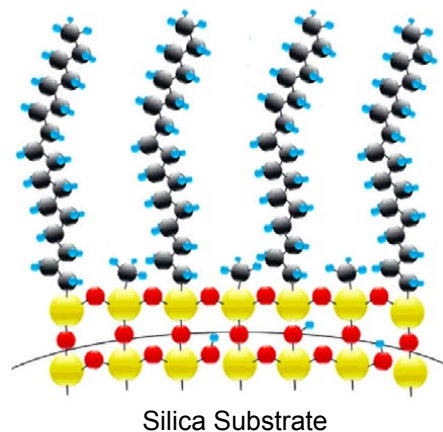

Silica Substrate

Fully Endcapped Conventional Bonded Phase

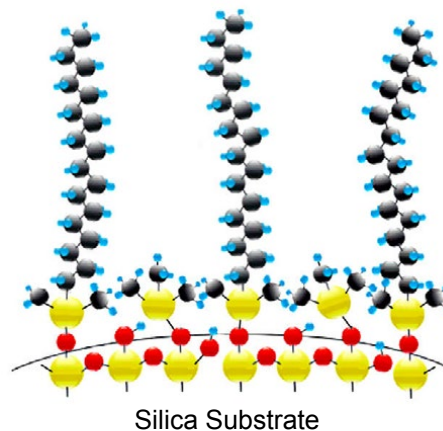

Silica Substrate

SAM is applicable to virtually all types of functional groups

SMT SAM-C18 Columns

SMT SAM-C18 or [OD] column is usually the first column of choice for reversed-phase chromatographic separation or method development. When compared to other columns such as a C8, C4, CN, phenyl, or an amino bonded phase, C18 is the most hydrophobic.

SMT SAM-C18 column is very stable at a wide pH range and high temperatures. Separation of most basic solutes is often possible without trifluoroacetic acid (TFA) or other mobile phase additives. SMT SAM-C18 columns enable you to achieve a broader pH range than what is accessible with other commercially available C18 columns. SMT utilizes a novel self-assembled monolayers technology in all its bonding chemistries to achieve maximum bonded phase coverage possible. The technique involves pretreatment of the silica substrate including rigorous control of water molecules. A mixture of trifunctional ligands is then allowed to come in contact with the substrate. The result is an unprecedented high-density assembly of these functional molecules on the substrate. The unique aspect of SAM is that only a monolayer of coverage is achieved when the bonding is performed accordingly. At least one of the ligands (e.g. C18) is functional for the target separation while the other (e.g. C1, C2 or C3) is used as a spacer molecule, although, it too can impact certain selectivity needed for some separation. A typical coverage achievable with SAM is 7-8 $\mu\text{mol}/\text{m}^2$. This coverage value is equivalent to the maximum achievable coverage on any substrate and it is about 50% higher than that achievable using the most exhaustive conventional bonding and end-capping methods available in the market today.

Important Information about of SMT SAM-Columns

It is very important to point out that SMT-C18 columns, as well as all the other columns introduced in this catalog, are unique in their applications; these are not just a "me too products" and while in most cases, the columns may show relatively similar selectivities when compared with other commercially available C18 columns in the market, subtle differences in separation of most complex molecules are often possible. SMT columns generally contain mixed ligands that are necessary for the extremely high stability and surface coverage. Furthermore, SMT columns are made with SAM total coverage™ technology and are designed to be truly base-deactivated. SAM ensures effective control of residual silanol activity on columns. Example of this fact is demonstrated by the chromatograms of a strong basic compound, dextromethorphan, which adsorbs easily by trace amounts of residual silanols on the surface of the packing material, resulting in poor peak shapes with conventional endcapped bonded phases made by competitors. The chromatograms show clearly how retention of dextromethorphan is controlled by the residual silanols on each of the columns evaluated.



SMT SAM-C18 vs Competitors

Retention of Dextromethorphan

Column: SMT OD-5-100/25
Solutes: 1=Uracil
 2=Dextromethorphan
Eluent: ACN: 0.025M Potassium Phosphate, pH=7
 40:60 (v:v)
Flow: 1.0 mL/min
Detector: UV; 220nm
Temp: 30°C

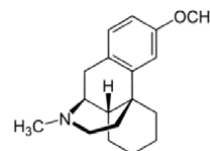
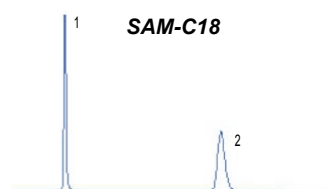

Dextromethorphan is a strong basic compound that will adsorb on trace amounts of residual silanols in column packing materials

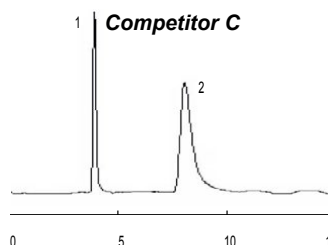
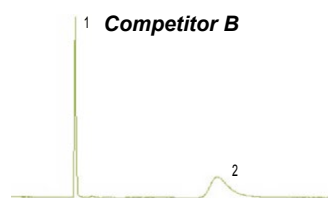
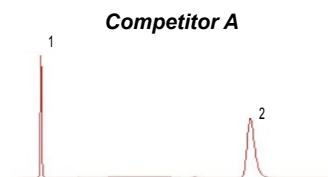

Unique Characteristics of SAM

1. SMT SAM-C18 shows unprecedented Stability in wide range of pH conditions

SMT SAM columns and packings are manufactured to resist hydrolysis at wide pH environments as demonstrated by the following comparative studies.

Effect of pH on solute retention: k' [BaP] vs column volumes

Column: OD-5-100/15 vs Competitors
 Solutes: Benzo[a]Pyrene [BaP]
 Eluent: ACN: Water 50:50 (v:v); (HCl: pH=1)
 or (NaOH: pH=12)
 Flow: 1.0 mL/min
 Detector: UV; 254nm
 Temp: 30°C

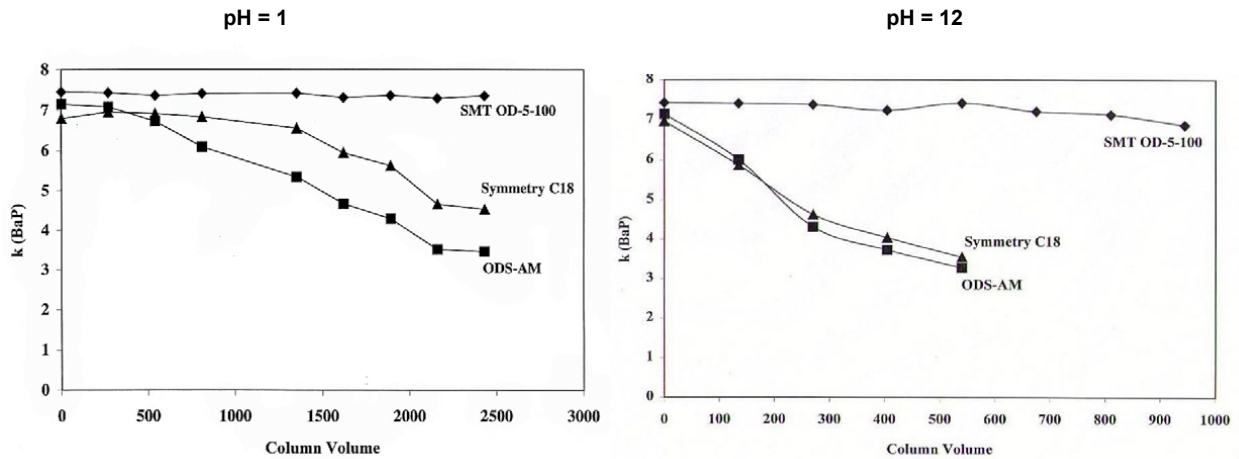

k' (BaP) remains fairly constant on SMT SAM-C18 column after several column volumes in both low pH and high pH conditions

Effect of Temperature on Solute Retention

Solutes: 1=Uracil
 2=Benzo[a]Pyrene
 Eluent: ACN: Water 50:50 (v:v)
 Flow: 1.0 mL/min
 Detector: UV; 254nm
 Temp: 30°C

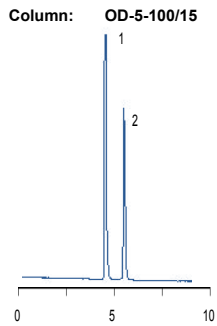

Column: Competitor's C18

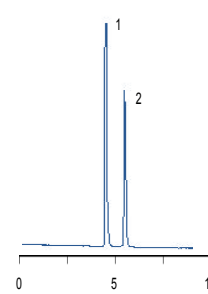

Solutes: 1=Uracil
 2=Benzo[a]Pyrene
 Eluent: ACN: Water 50:50 (v:v)
 Flow: 1.0 mL/min
 Detector: UV; 254nm
 Temp: 90°C

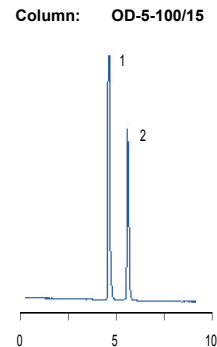

k' remains constant after several analyses at very high temperatures - showing column stability

Column: Competitor's C18

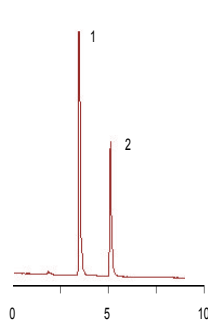

k' changes after several analyses at very high temperatures - showing column instability

Unique Characteristics of SAM

3. SMT SAM-C18 results in no tailing, even for difficult analytes

Silanophilic interaction can often preclude elution of basic analytes with symmetric peaks in conventional C18 columns. Mobile phase additives such as TFA or buffer are often used to suppress the interaction. Separation of most basic compounds on SMT SAM-C18 is often possible without these additives.

Basic analytes: separation of Anilines

Solutes: 1=Uracil
2=Aniline
3=N,N-dimethylaniline
4=N,N-diethylaniline
Eluent: ACN: Water 60:40 (v:v)
Flow: 1.0 mL/min
Detector: UV; 254nm
Temp: 30°C

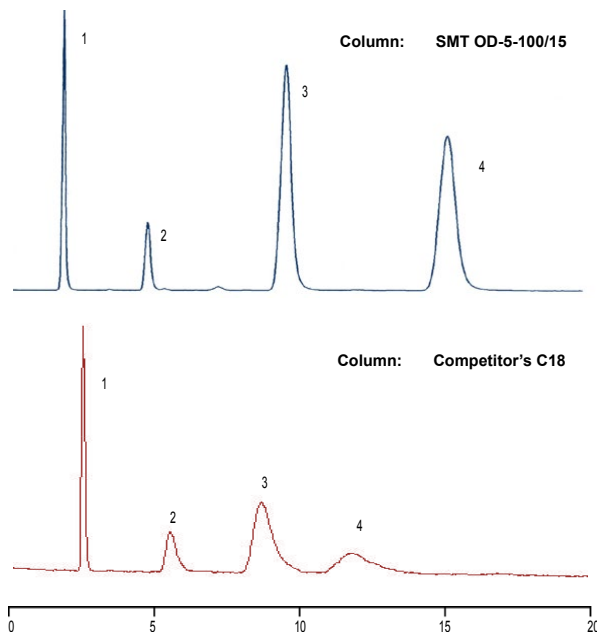

Basic analytes such as simple Anilines are strongly retained on competitor's C18 columns because of trace amounts of residual silanols in column packing materials used. SMT SAM-C18 columns are made using Total coverage™ technique and as reduce such interactions.

4. High Efficiency, Reproducibility, and Symmetry

SMT SAM columns and packing materials are manufactured to provide high efficiency, reproducibility and symmetry. Extremely tight manufacturing controls as well as extensive characterization of the silica substrates and the bonded phases enable us to manufacture all our columns and packings with all of these important features. Typical efficiencies are in the order of 65,000 plates per meter on our probe molecules. Our SAM technology ensures production of columns and packings of extremely high reproducibility with symmetry in the order of 1.0.

Batch-to-Batch Reproducibility

A result of 6 batches of SMT SAM-C18 and SAM-C8

SAM OD-Columns	Batch #1	Batch #2	Batch #3	Batch #4	Batch #5	Batch #6
Particle Size:	5 µm	5 µm	5 µm	5 µm	5 µm	5 µm
Pore Size:	100Å	100Å	100Å	100Å	100Å	100Å
Surface area [m ² /g]:	340	340	340	340	340	340
% Carbon:	24	24	24	24	24	24
Coverage [µmoles/m ²]:	7.4	7.4	7.3	7.3	7.4	7.3

SAM O-Columns	Batch #1	Batch #2	Batch #3	Batch #4	Batch #5	Batch #6
Particle Size:	5 µm	5 µm	5 µm	5 µm	5 µm	5 µm
Pore Size:	100Å	100Å	100Å	100Å	100Å	100Å
Surface area [m ² /g]:	340	340	340	340	340	340
% Carbon:	12	12	12	12	12	12
Coverage [µmoles/m ²]:	7.4	7.3	7.3	7.3	7.4	7.4

SMT SAM-C18 Columns

Special features:

- Very hydrophobic
- Designed to tolerate usage in very aggressive pH conditions [1-12]
- Stable at extended temperature range [25 °C to 90 °C]

SMT offers different C18 phases of varying carbon loads for optimal selectivity

OD series:

SMT SAM-C18 phase with the highest functional ligand coverage confirmed with carbon analysis results of 24% carbon load. In these series, a very high density of the functional ligand, octadecyl (C18) molecule, is achieved through meticulous mixture of the C18 with proprietary spacer molecules to ensure maximum coverage. These phases are very hydrophobic and are designed to tolerate usage in very aggressive pH conditions and high temperatures.

ODL series:

SMT SAM-C18 phase with the lowest functional ligand coverage confirmed with carbon analysis results of 12% carbon load. In these series, the proportional ratio of the functional C18 molecule, mixed with the proprietary spacer molecule, is reduced. The result is a packing material with maximum coverage but much lower functional ligand. Low density C18 packing material ensures faster mass transfer of solutes during separation. These phases have much lower hydrophobicity compared to the standard SMT OD-series. The spacer molecules protect the substrate from aggressive pH conditions and impact unique selectivity compared with other C18 phases.

EliteC18 series:

SMT SAM-C18 phases with the intermediate functional ligand coverage confirmed with carbon analysis results of 16% carbon load. In these series, the density of the functional ligand, octadecyl molecule or C18, is moderated with the proprietary spacer molecule to ensure maximum coverage. These phases are moderately hydrophobic; nevertheless, designed to tolerate usage in very aggressive pH conditions and high temperatures.

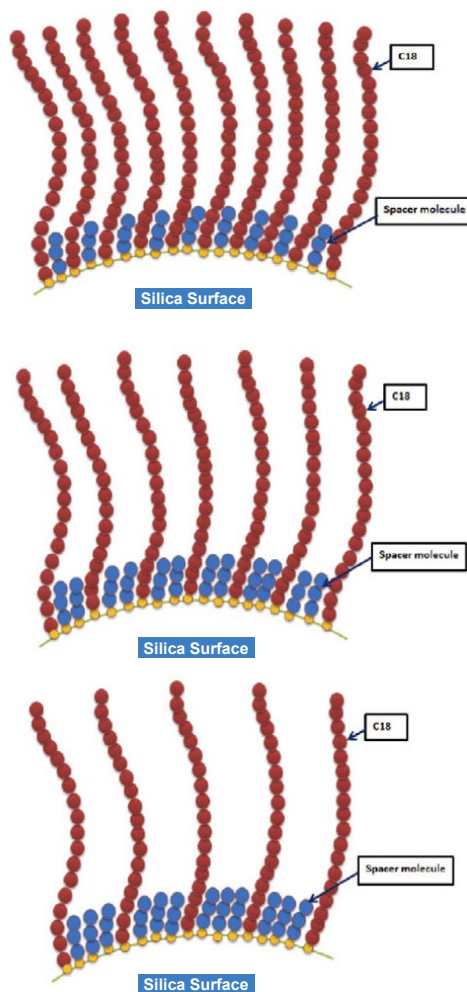

All SMT SAM-C18 packing materials are available for preparatory, solid phase extraction and process scale applications. Please refer to our bulk packing materials section of this catalog for various particle sizes available for your applications.

SMT SAM-C18 [OD-Series]

Special features:

- SMT-C18 phase with the highest functional ligand density consisting of about 24% carbon load.
- Highly versatile; strongly recommended for basic compounds.
- Offers high selectivity for polar, neutral and moderately nonpolar pharmaceuticals, natural products, food additives, organic chemicals and biologicals.

OD-Columns are available in various particle and pore sizes: 3, 5, 10 μm and 100 and 300Å are stock sizes

Typical Column Specification:	SAM OD-Columns	
5 μm Silica	100Å	300Å
Surface Area [m^2/g]	340	120
% Carbon	24	8
Coverage [moles/m^2]	7.4	7.2

Ordering Information

SAM-C18 (OD-columns) 3 μm , 100Å

* Column Dimension (length x i.d.)

50mmx4.6mm
75mmx4.6mm
100mmx4.6mm
150mmx4.6mm

Catalog Number

OD-3-100/5
OD-3-100/7.5
OD-3-100/10
OD-3-100/15

SAM-C18 (OD-columns) 5 μm , 100Å

* Column Dimension (length x i.d.)

50mmx4.6mm
75mmx4.6mm
100mmx4.6mm
150mmx4.6mm
250mmx4.6mm
300mmx4.6mm

Catalog Number

OD-5-100/5
OD-5-100/7.5
OD-5-100/10
OD-5-100/15
OD-5-100/25
OD-5-100/30

SAM-C18 (OD-columns) 10 μm , 100Å

* Column Dimension (length x i.d.)

50mmx4.6mm
75mmx4.6mm
100mmx4.6mm
150mmx4.6mm
250mmx4.6mm
300mmx4.6mm

Catalog Number

OD-10-100/5
OD-10-100/7.5
OD-10-100/10
OD-10-100/15
OD-10-100/25
OD-10-100/30

SAM-C18 (OD-columns) 5 μm , 300Å

* Column Dimension (length x i.d.)

50mmx4.6mm
75mmx4.6mm
100mmx4.6mm
150mmx4.6mm
250mmx4.6mm
300mmx4.6mm

Catalog Number

OD-5-300/5
OD-5-300/7.5
OD-5-300/10
OD-5-300/15
OD-5-300/25
OD-5-300/30

SAM-C18 (OD-columns) 10 μm , 300Å

* Column Dimension (length x i.d.)

50mmx4.6mm
75mmx4.6mm
100mmx4.6mm
150mmx4.6mm
250mmx4.6mm
300mmx4.6mm

Catalog Number

OD-10-300/5
OD-10-300/7.5
OD-10-300/10
OD-10-300/15
OD-10-300/25
OD-10-300/30

SAM-C18 (OD-columns) 5 μm , 60Å

* Column Dimension (length x i.d.)

50mmx4.6mm
75mmx4.6mm
100mmx4.6mm
150mmx4.6mm
250mmx4.6mm
300mmx4.6mm

Catalog Number

OD-5-60/5
OD-5-60/7.5
OD-5-60/10
OD-5-60/15
OD-5-60/25
OD-5-60/30

*Guard column: 20mmx4.0mm; add suffix G to Catalog Number

*Other dimensions available; Please contact SMT, Inc. for quotation



Polar Compounds: Phenols

Column: OD-5-100/15

Solutes:
1=Uracil
2=Phenol
3=2-nitrophenol
4=4-nitrophenol
5=2-methyl-4,6-dinitrophenol
6=4-chloro-3-methylphenol
7=2,4-dichlorophenol
8=2,4,6-trichlorophenol
9=pentachlorophenol

Eluent: Methanol: Water ; Linear gradient in 25 min

Flow: 1.0 mL/min

Detector: UV; 254nm

Temp: 30°C

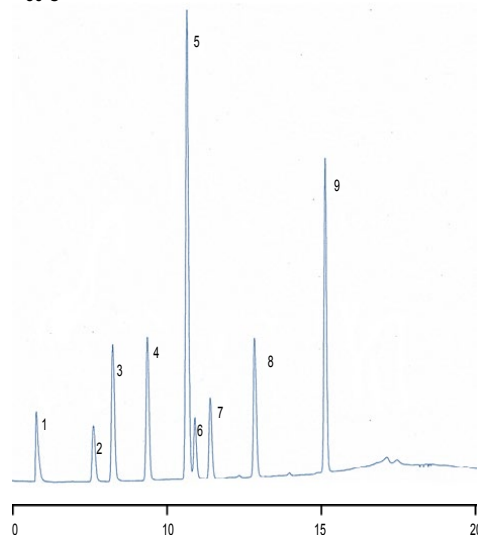

Applications of SMT SAM-C18 [OD-Series]

Nonpolar Compounds

Column: OD-5-100/15

Solutes:
1=Uracil
2=Benzene
3=Toluene
4=Naophthalene
5=t-Butyl Benzene
6=Anthracene

Eluent: Methanol: Water 70:30 (v:v)

Flow: 1.0 mL/min

Detector: UV; 254nm

Temp: 30°C

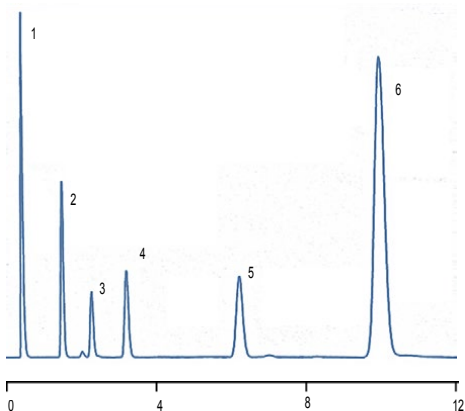

Basic Drugs

Column: OD-5-100/15

Solutes:
1=Cocaine
2=Procaine
3=Lidocaine
4=Amylocaine

Eluent: ACN: Water 70:30 (v:v)

Flow: 1.0 mL/min

Detector: UV; 254nm

Temp: 30°C

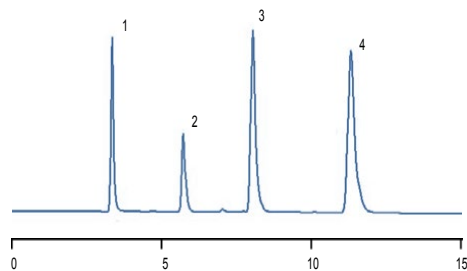

Natural Products

Column: OD-5-100/15

Solutes:
1=Capsaicin
2=Dihydrocapsaicin
3=Homocapsaicin

Eluent: ACN: Water 60:40 (v:v)

Flow: 1.0 mL/min

Detector: UV; 230nm

Temp: 30°C

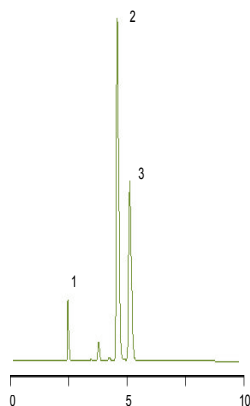

Herbicides

Column: OD-5-100/15

Solutes:
1=Tebutiuron
2=Simazine
3=Altrazine
4=Propazine

Eluent: ACN: Water 70:30 (v:v)

Flow: 1.0 mL/min

Detector: UV; 210nm

Temp: 30°C

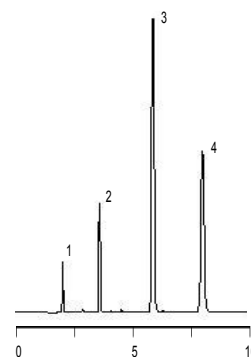

SMT SAM-C18 [ODL-Series]

Special features:

- Fast mass transfer and very high efficiency for the separation of highly hydrophobic molecules.
- Low hydrophobicity. The spacer molecules have much fewer carbon chains; nevertheless, the effective cross-linking with the functional ligands offers adequate protection to the substrate material against aggressive pH conditions.
- Offers unique selectivity compared with other C18 phases. The higher population of the spacer molecules provides the unique mixed-mode effect for the selectivity.

ODL-Columns are available in various particle and pore sizes: 5, 10 μm and 100, 120 and 300 \AA are stock sizes



Typical Column Specification:	SAM ODL-Columns	
5 μm Silica	100 \AA	300 \AA
Surface Area [m^2/g]	340	90
% Carbon	12	4
Coverage [moles/m^2]	7.4	7.3

Ordering Information

SAM-C18 (ODL-columns) 3 μm , 100 \AA

* Column Dimension (length x i.d.)

50mmx4.6mm
75mmx4.6mm
100mmx4.6mm
150mmx4.6mm

Catalog Number

ODL-3-100/5
ODL-3-100/7.5
ODL-3-100/10
ODL-3-100/15

SAM-C18 (ODL-columns) 5 μm , 100 \AA

* Column Dimension (length x i.d.)

50mmx4.6mm
75mmx4.6mm
100mmx4.6mm
150mmx4.6mm
250mmx4.6mm
300mmx4.6mm

Catalog Number

ODL-5-100/5
ODL-5-100/7.5
ODL-5-100/10
ODL-5-100/15
ODL-5-100/25
ODL-5-100/30

SAM-C18 (ODL-columns) 10 μm , 100 \AA

* Column Dimension (length x i.d.)

50mmx4.6mm
75mmx4.6mm
100mmx4.6mm
150mmx4.6mm
250mmx4.6mm
300mmx4.6mm

Catalog Number

ODL-10-100/5
ODL-10-100/7.5
ODL-10-100/10
ODL-10-100/15
ODL-10-100/25
ODL-10-100/30

SAM-C18 (ODL-columns) 5 μm , 300 \AA

* Column Dimension (length x i.d.)

50mmx4.6mm
75mmx4.6mm
100mmx4.6mm
150mmx4.6mm
250mmx4.6mm
300mmx4.6mm

Catalog Number

ODL-5-300/5
ODL-5-300/7.5
ODL-5-300/10
ODL-5-300/15
ODL-5-300/25
ODL-5-300/30

*Guard column: 20mmx4.0mm; add suffix G to Catalog Number

*Other dimensions available; Please contact SMT, Inc. for quotation

Hydrophobic Compounds

Column: OD vs ODL columns

Solutes: 1=Tebuthiuron

2=Simazine

3=Altrazine

4=Propazine

Eluent: ACN: Water 70:30 (v:v)

Flow: 1.0 mL/min

Detector: UV; 254nm

Temp: 30°C

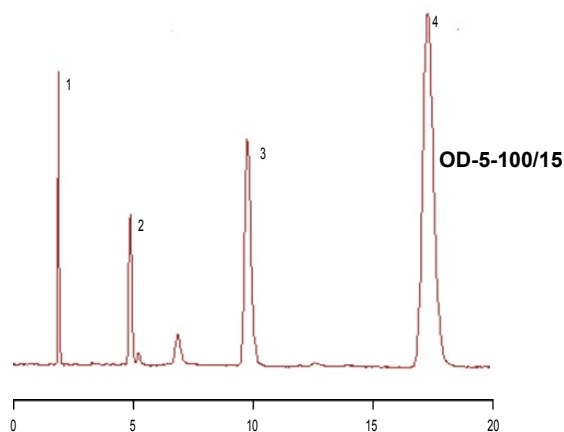
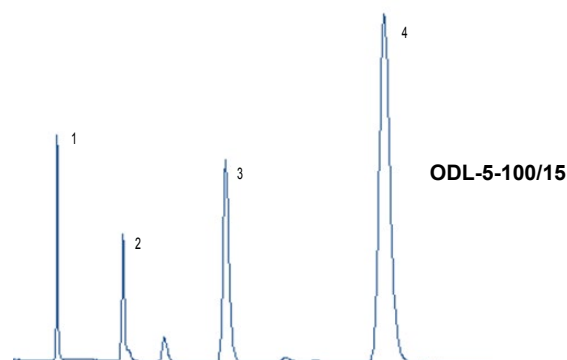

Application of SMT SAM-C18 [ODL-Series]

Antimalarial Drugs

Column: ODL-5-100/15
Solutes: 1=Chloroquine
2=Cinchonine
3=Quinine
4=Cinchonine Degradant
Eluent: ACN:0.05M Potassium Phosphate, Monobasic, pH=3 (20:80)
Flow: 1.0 mL/min
Detector: UV; 254nm
Temp: 30°C

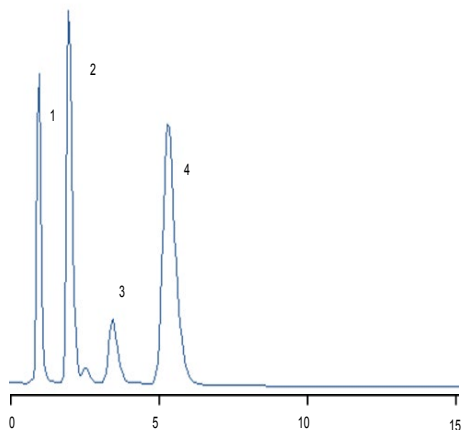

Drug molecules: Barbiturates

Column: ODL-5-100/15
Solutes: 1=Sulfanilamide
2=Cefaclor
3=Cefatrizine
4=Thiamphenicol
5=Cefotaxime
Eluent: ACN:0.01M Potassium Phosphate, pH=3, 25:75
Flow: 1.0 mL/min
Detector: UV; 265nm
Temp: 30°C

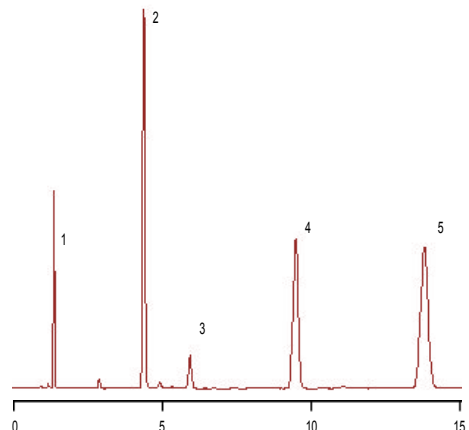

Drugs: Ciprofloxacin

Column: ODL-5-100/15
Solutes: 1=Ciprofloxacin ethylenediamine Analog
2=Ciprofloxacin hydrochloride
Eluent: ACN: 0.025M phosphoric acid, pH=3, 15:85 (v:v)
Flow: 1.0 mL/min
Detector: UV; 278nm
Temp: 30°C

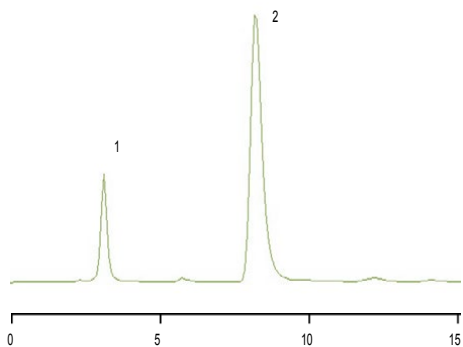
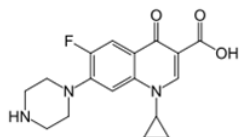

Antihypertensives

Column: ODL-5-100/15
Solutes: 1=Pindolol
2=Metoprolol
3=Oxprenolol
4=Propranolol
Eluent: ACN:0.1M Potassium Phosphate, Monobasic, pH=3 (60:40)
Flow: 1.0 mL/min
Detector: UV; 220nm
Temp: 30°C

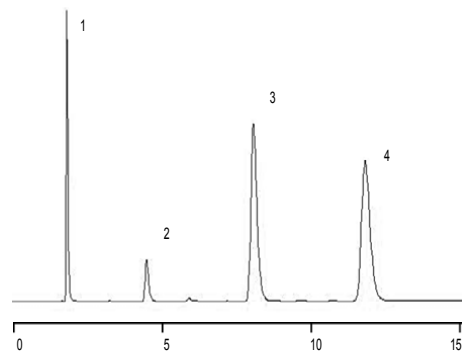

SMT EliteC18 Columns

Special features:

- Moderately hydrophobic; Offers comparable carbon load as most other commercially available C18 columns and faster mass transfer than SAM OD-series.
- Excellent peak symmetry; highly versatile; offers very good selectivity for polar and Moderately nonpolar pharmaceuticals and biomolecules.
- High efficiency

EliteC18 Columns are available in 5 and 10µm particle sizes and 100Å pore size

Typical Column Specification:	SAM Elite-C18 Columns
5 µm Silica	100Å
Surface Area [m ² /g]	340
% Carbon	16
Coverage [moles/m ²]	7.4

Ordering Information

SMT EliteC18-5 5 µm, 100Å

* Column Dimension (length x i.d.)

50mmx4.6mm
75mmx4.6mm
100mmx4.6mm
150mmx4.6mm
250mmx4.6mm
300mmx4.6mm

* Column Dimension (length x i.d.)

50mmx3.9mm
75mmx3.9mm
100mmx3.9mm
150mmx3.9mm
250mmx3.9mm
300mmx3.9mm

Catalog Number

EliteC18-5-100/5
EliteC18-5-100/7.5
EliteC18-5-100/10
EliteC18-5-100/15
EliteC18-5-100/25
EliteC18-5-100/30

Catalog Number

EliteC18-5-100/54
EliteC18-5-100/7.54
EliteC18-5-100/104
EliteC18-5-100/154
EliteC18-5-100/254
EliteC18-5-100/304

SMT EliteC18-10 10 µm, 100Å

* Column Dimension (length x i.d.)

50mmx4.6mm
75mmx4.6mm
100mmx4.6mm
150mmx4.6mm
250mmx4.6mm
300mmx4.6mm

* Column Dimension (length x i.d.)

50mmx3.9mm
75mmx3.9mm
100mmx3.9mm
150mmx3.9mm
250mmx3.9mm
300mmx3.9mm

Catalog Number

EliteC18-10-100/5
EliteC18-10-100/7.5
EliteC18-10-100/10
EliteC18-10-100/15
EliteC18-10-100/25
EliteC18-10-100/30

Catalog Number

EliteC18-10-100/54
EliteC18-10-100/7.54
EliteC18-10-100/104
EliteC18-10-100/154
EliteC18-10-100/254
EliteC18-10-100/304

*Guard column: 20mmx4.0mm; add suffix G to Catalog Number

+Other dimensions available; Please contact SMT, Inc. for quotation



Analgesics Compounds

Column: EliteC18-5-100/154

Solutes: 1= acetaminophen
2= codeine
3= oxycodone
4= hydroxycodone

Eluent: Acetonitrile: Water 85:15 (v:v)

Flow: 1.0 mL/min

Detector: UV; 280nm

Temp: 30°C

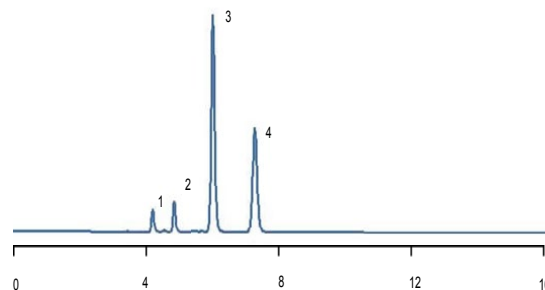

Analgesics Compounds

Column: EliteC18-5-100/15

Solutes: 1= uracil
2= ibuprofen
3= pseudoephedrine
4= naproxen

Eluent: Acetonitrile: Water 75:25 (v:v)

Flow: 1.0 mL/min

Detector: UV; 220nm

Temp: 30°C

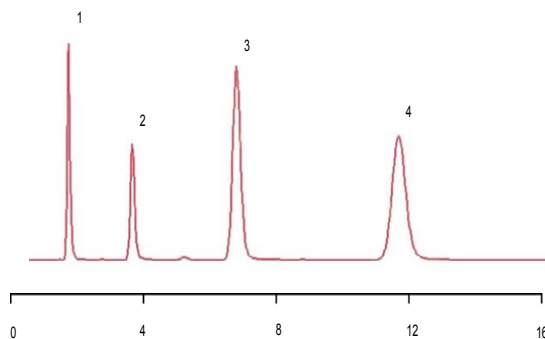

Applications of SMT EliteC18 Columns

Drug Molecules: Mevacor®

Column: EliteC18-5-100/15
Solutes: 1=Lovastatin
Eluent: ACN: 0.05%TFA-Water 30:70 (v:v)
Flow: 1.0 mL/min
Detector: UV; 240nm
Temp: 30°C

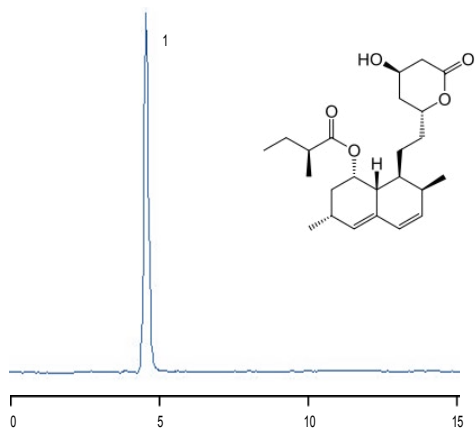

Biomolecules: NPH Insulin

Column: EliteC18-5-100/15
Solutes: 1=unknown
2=Insulin
Eluent: ACN: 0.01% TFA water [pH=2]
30:70 gradient to 40:60 (v:v) in 10 min
Flow: 1.0 mL/min
Detector: UV; 210nm
Temp: 30°C

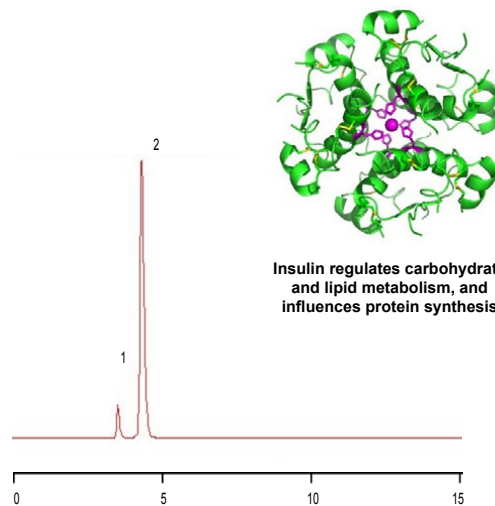

Antibiotics Drugs: Penicillins

Column: EliteC18-5-100/154
Solutes: 1=Ampicillin
2=Oxacillin
3=Cloxacillin
4=Flucloxacillin
Eluent: ACN: 0.05M phosphate buffer [pH=7] 25:75 (v:v)
Flow: 1.5 mL/min
Detector: UV; 230nm
Temp: 30°C

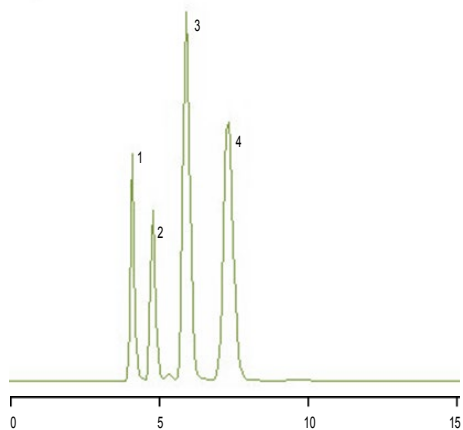

Drug molecules: Respiratory Stimulants

Column: EliteC18-5-100/15
Solutes: 1=Theophylline
2=Caffeine
3=Ethamivan
4=8-chlorotheophylline
Eluent: Methanol:ACN:1% Acetic acid, pH=3, (3:10:60)
Flow: 1.0 mL/min
Detector: UV; 254nm
Temp: 30°C

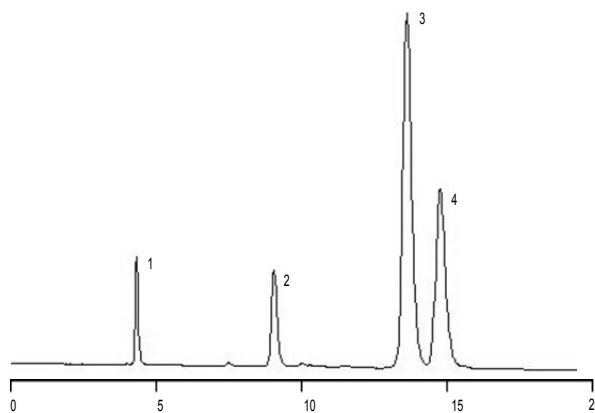

SMT SAM-C8 Columns

SMT's unique bonding method produces very high ligand density silica based octyl (C8) column packing material which results in chromatographic properties unlike any other silica-based C8 column support. SMT's C8 column is designed for optimum peak shape, peak capacity and high chromatographic efficiency for both acidic and basic solutes.

SMT's C8 column is very stable at extreme pH conditions and high temperatures. The column is strongly recommended for the separation of most basic solutes that have high concentration of very hydrophobic functional groups. C8 column is usually the second column of choice after C18 for method developments using reversed-phase chromatographic separation. When compared to other columns such as C4, CN, phenyl, or an amino bonded phase, the C8 is the most hydrophobic.

Although C18 remains the most widely used, the use of the C8 phase has increased in recent years and represents a good compromise phase. C8 phase normally provides equivalent selectivity; it is not too hydrophobic, and yet it retains many compounds on the basis of interaction with their hydrophobic groups. C8 phases are good choices when too much organic solvent is required to elute the analytes of interest (especially highly hydrophobic molecules) from a C18 phase. The use of C8 columns reduces retention time and consumption of organic solvents

SMT offers different C8 phases of varying carbon loads for optimal selectivity:

O series

SMT SAM-C8 phase with the highest functional ligand coverage confirmed with carbon analysis results of 12% carbon load. In these series, a very high density of the functional ligand, octyl molecule or C8, is achieved through meticulous mixture of the C8 with proprietary spacer molecules to ensure maximum coverage. These phases are very hydrophobic and are designed to tolerate usage in mildly aggressive pH conditions and high temperatures. SMT SAM-C8 columns are designed to withstand a pH range of 1-10. The columns are generally stable up to 50% better than other competitors used under similar conditions.

OL series

SMT SAM-C8 phase with the lowest functional ligand coverage confirmed with carbon analysis results of 6% carbon load. In these series, the proportional ratio of the functional ligand, octyl or C8 molecule, mixed with the proprietary spacer molecule, is reduced. The result is a packing material with maximum coverage but much lower functional ligand density. Low density C8 packing material ensures faster mass transfer of solutes during separation. These phases have low hydrophobicity. The spacer molecules protect the substrate from aggressive pH conditions and impact unique selectivity compared with other C8 phases.

EliteC8 - series

SMT SAM-C8 phases with the intermediate functional ligand coverage confirmed with carbon analysis results of 10% carbon load. In these series, the density of the functional ligand, octyl molecule or C8, is moderated with the proprietary spacer molecule to ensure maximum coverage. These phases are moderately hydrophobic; nevertheless, designed to tolerate usage in very aggressive pH conditions and high temperatures.

All SMT SAM-C8 packing materials are available for preparatory, solid phase extraction and process scale applications. Please refer to our bulk packing materials catalog for various particle sizes available for your application.

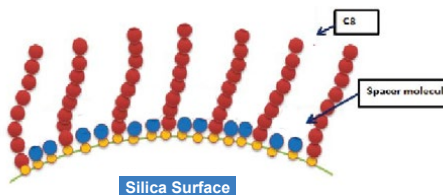
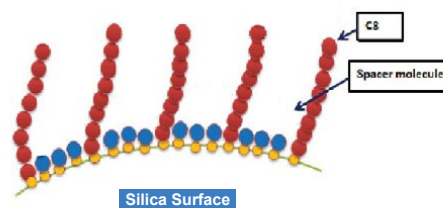
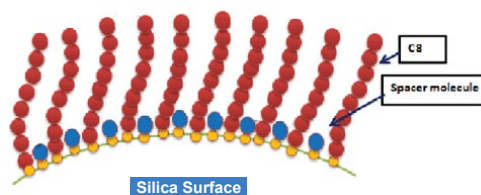

SMT SAM-C8 [O-Series]

Special features:

- Moderately hydrophobic and are designed to tolerate usage in mildly aggressive pH conditions.
- Highly versatile; offers selectivity for polar and moderately nonpolar pharmaceuticals, natural products, organic chemicals and biologicals.

O-Columns are available in various particle and pore sizes: 3, 5, 10 μm and 100 and 300Å are stock sizes



Typical Column Specification:	SAM O-Columns	
5 μm Silica	100Å	300Å
Surface Area [m^2/g]	340	120
% Carbon	24	5
Coverage [moles/m^2]	7.4	7.2

Hydrophobicity: C8 vs C18

Analysis of nonpolar compounds

Column: O-5-100/15 vs OD-5-100/15

Solutes:
 1=uracil
 2=benzene
 3=toluene
 4=naphthalene
 5=iso-butylbenzene
 6=anthracene

Eluent: ACN: Water 60:40 (v:v)
 Flow: 1.0 mL/min
 Detector: UV: 254nm
 Temp: 30°C

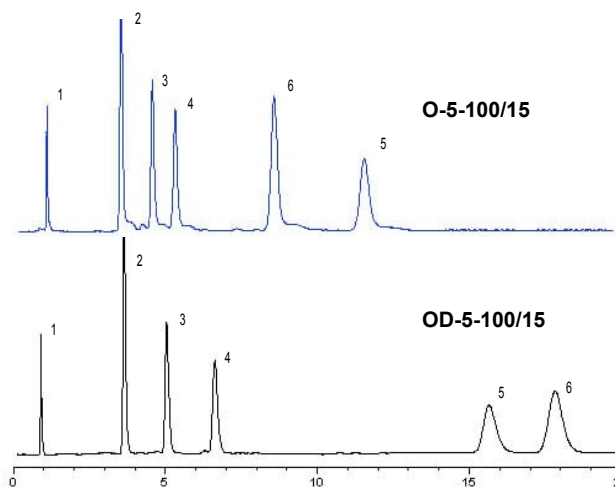

C8 usually offers similar selectivities as C18 but with reduced retention of hydrophobic analytes.

Note the change in selectivities of isobutyl benzene and anthracene when SMT SAM-C8 is compared with SAM-C18 under similar chromatographic conditions

Ordering Information

SAM-C8 (O-columns) 3 μm , 100Å

* Column Dimension (length x i.d.)

50mmx4.6mm
 75mmx4.6mm
 100mmx4.6mm
 150mmx4.6mm

Catalog Number
 O-3-100/5
 O-3-100/7.5
 O-3-100/10
 O-3-100/15

SAM-C8 (O-columns) 5 μm , 100Å

* Column Dimension (length x i.d.)

50mmx4.6mm
 75mmx4.6mm
 100mmx4.6mm
 150mmx4.6mm
 250mmx4.6mm
 300mmx4.6mm

Catalog Number
 O-5-100/5
 O-5-100/7.5
 O-5-100/10
 O-5-100/15
 O-5-100/25
 O-5-100/30

SAM-C8 (O-columns) 10 μm , 100Å

* Column Dimension (length x i.d.)

50mmx4.6mm
 75mmx4.6mm
 100mmx4.6mm
 150mmx4.6mm
 250mmx4.6mm
 300mmx4.6mm

Catalog Number
 O-10-100/5
 O-10-100/7.5
 O-10-100/10
 O-10-100/15
 O-10-100/25
 O-10-100/30

SAM-C8 (O-columns) 5 μm , 300Å

* Column Dimension (length x i.d.)

50mmx4.6mm
 75mmx4.6mm
 100mmx4.6mm
 150mmx4.6mm
 250mmx4.6mm
 300mmx4.6mm

Catalog Number
 O-5-300/5
 O-5-300/7.5
 O-5-300/10
 O-5-300/15
 O-5-300/25
 O-5-300/30

SAM-C8 (O-columns) 10 μm , 300Å

* Column Dimension (length x i.d.)

50mmx4.6mm
 75mmx4.6mm
 100mmx4.6mm
 150mmx4.6mm
 250mmx4.6mm
 300mmx4.6mm

Catalog Number
 O-10-300/5
 O-10-300/7.5
 O-10-300/10
 O-10-300/15
 O-10-300/25
 O-10-300/30

SAM-C8 (O-columns) 5 μm , 60Å

* Column Dimension (length x i.d.)

50mmx4.6mm
 75mmx4.6mm
 100mmx4.6mm
 150mmx4.6mm
 250mmx4.6mm
 300mmx4.6mm

Catalog Number
 O-5-60/5
 O-5-60/7.5
 O-5-60/10
 O-5-60/15
 O-5-60/25
 O-5-60/30

*Guard column: 20mmx4.0mm; add suffix G to Catalog Number

*Other dimensions available; Please contact SMT, Inc. for quotation

Applications of SMT SAM-C8

Organic Acids

Column: O-10-100/15
Solutes: 1=Oxalic acid
2=Tartaric acid
3=Lactic acid
4=Maleic acid
Eluent: Methanol: 0.02M Potassium Phosphate
Monobasic [pH=2.5] 5:95 (v:v)
Flow: 1.0 mL/min
Detector: UV; 220nm
Temp: 30°C

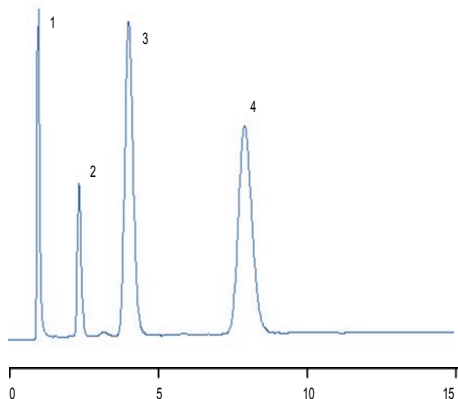

Antibacterial: Tetracyclines

Column: O-5-100/15
Solutes: 1=minocycline
2=oxytetracycline
3=tetracycline
4=demeclocycline
5=chlorotetracycline
6=methacycline
7=doxycycline
8=meclocycline
Eluent: ACN: 0.02% TFA water, pH=2, 25:75 (v:v)
Flow: 1.0 mL/min
Detector: UV; 254nm
Temp: 30°C

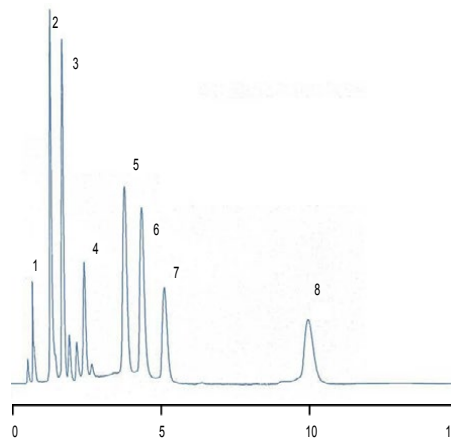

Biomolecules: Nucleic Acid Bases

Column: O-5-100/15
Solutes: 1=Uracil
2=Thymine
3=Guanine
4=Adenine
Eluent: A=ACN; B=0.03M Potassium Phosphate, Monobasic, pH=3
0 -20% A in 15 min
Flow: 1.0 mL/min
Detector: UV; 220nm
Temp: 30°C

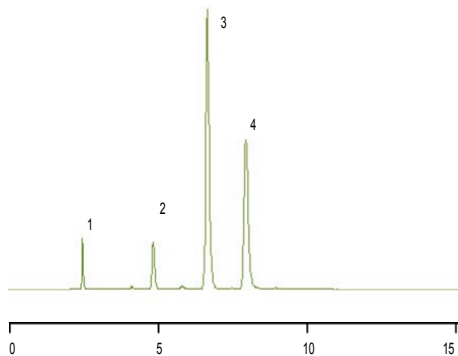

Food: Flavonoids

Column: O-5-100/10
Solutes: 1=Catechin
2=Naringin
3=Hesperidin
4=Coumarin
Eluent: A=Methanol B=0.03M Ammonium Acetate, pH=4.5
40:60 A:B to 60:40 A:B in 10 min
Flow: 1.0 mL/min
Detector: UV; 280nm
Temp: 30°C

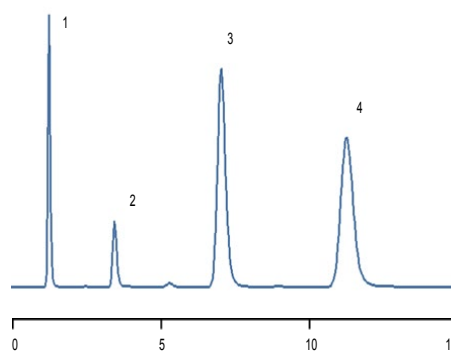

SMT SAM-C8 [OL-Series]

Special features:

- Fast mass transfer and high efficiency for the separation of highly hydrophobic molecules.
- Offers unique selectivity compared with other C8 phases.
- Higher population of spacer molecules provides unique mixed-mode effect for the selectivity.
- Stable bonding for long column lifetimes.

OL-Columns are available in various particle and pore sizes: 5, 10 µm, 100 and 300Å are stock sizes

Typical Column Specification:	SAM OL-Columns	
5 µm Silica	100Å	300Å
Surface Area [m ² /g]	340	90
% Carbon	6	2
Coverage [moles/m ²]	7.4	7.2

Ordering Information

SAM-C8 (OL-columns) 3 µm, 100Å

* Column Dimension (length x i.d.)

50mmx4.6mm
75mmx4.6mm
100mmx4.6mm
150mmx4.6mm

Catalog Number
OL-3-100/5
OL-3-100/7.5
OL-3-100/10
OL-3-100/15

SAM-C8 (OL-columns) 5 µm, 100Å

* Column Dimension (length x i.d.)

50mmx4.6mm
75mmx4.6mm
100mmx4.6mm
150mmx4.6mm
250mmx4.6mm
300mmx4.6mm

Catalog Number
OL-5-100/5
OL-5-100/7.5
OL-5-100/10
OL-5-100/15
OL-5-100/25
OL-5-100/30

SAM-C8 (OL-columns) 5 µm, 300Å

* Column Dimension (length x i.d.)

50mmx4.6mm
75mmx4.6mm
100mmx4.6mm
150mmx4.6mm
250mmx4.6mm
300mmx4.6mm

Catalog Number
OL-5-300/5
OL-5-300/7.5
OL-5-300/10
OL-5-300/15
OL-5-300/25
OL-5-300/30

SAM-C8 (OL-columns) 10 µm, 100Å

* Column Dimension (length x i.d.)

50mmx4.6mm
75mmx4.6mm
100mmx4.6mm
150mmx4.6mm
250mmx4.6mm
300mmx4.6mm

Catalog Number
OL-10-100/5
OL-10-100/7.5
OL-10-100/10
OL-10-100/15
OL-10-100/25
OL-10-100/30

SAM-C8 (OL-columns) 10 µm, 300Å

* Column Dimension (length x i.d.)

50mmx4.6mm
75mmx4.6mm
100mmx4.6mm
150mmx4.6mm
250mmx4.6mm
300mmx4.6mm

Catalog Number
OL-10-300/5
OL-10-300/7.5
OL-10-300/10
OL-10-300/15
OL-10-300/25
OL-10-300/30

*Guard column: 20mmx4.0mm; add suffix G to Catalog Number

+Other dimensions available; Please contact SMT, Inc. for quotation



Drugs: Antiemetics

Column: OL-5-100/15

Solutes: 1=Scopolamine
2=Metoclopramide
3=Cleobpride

Eluent: ACN:0.02M Potassium Phosphate, pH=3
30:70

Flow: 1.0 mL/min

Detector: UV; 220nm

Temp: 30°C

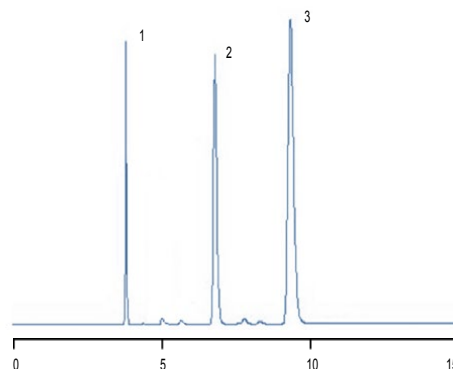

Anticonvulsants: Succinimides

Column: OL-5-100/154

Solutes: 1=Ethosuximide
2=Phensuximide
3=Mesuximide

Eluent: Methanol:0.1M Potassium Phosphate, pH=7
30:70

Flow: 1.0 mL/min

Detector: UV; 215nm

Temp: 30°C

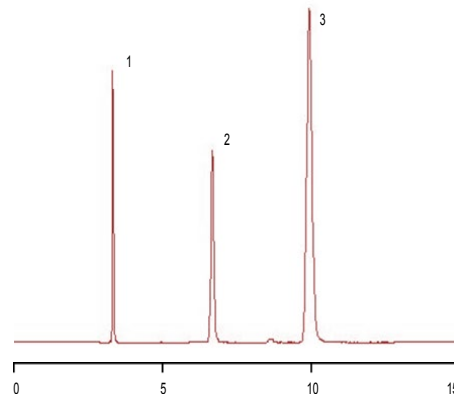

SMT-SAM-C8 [OL-Series]

AntiBacterial: Suprax®

Column: OL-5-100/104
Solutes: 1=Cefixime
2=unknown
Eluent: ACN: 0.05M Potassium phosphate
pH=3, 20:80
Flow: 1.0 mL/min
Detector: UV; 254nm
Temp: 30°C

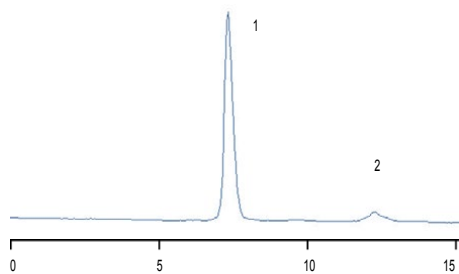
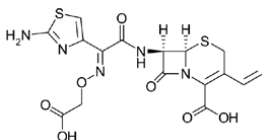

Analgesic: Tylenol® & Codeine

Column: OL-5-100/154
Solutes: 1=Acetaminophen
2=Codeine
Eluent: Methanol: 0.01M KH₂PO₄, pH=3, 25:75 (v:v)
Flow: 1.0 mL/min
Detector: UV; 254nm
Temp: 30°C

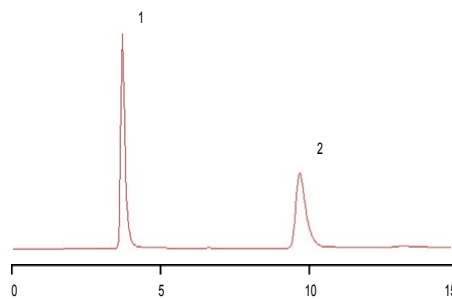

Drugs: Antiepileptics

Column: OL-5-100/15
Solutes: 1=p-Hydroxyphenobarbital
2=Phenobarbital
Eluent: Methanol: 0.1M Potassium Phosphate, pH=7
30:70 (v:v)
Flow: 1.0 mL/min
Detector: UV; 214nm
Temp: 30°C

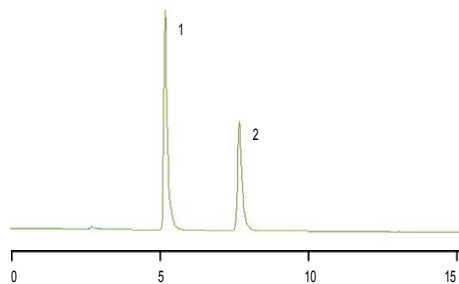

Antihistaminic: Actifed®

Column: OL-5-100/154
Solutes: 1=Pseudoephedrine
2=Triprolidine
Eluent: ACN: 0.05M Potassium Phosphate, pH=3, 30:70)
Flow: 1.0 mL/min
Detector: UV; 260nm
Temp: 30°C

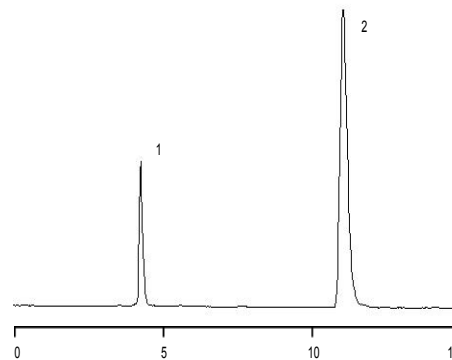

SMT EliteC8 Columns

Special features:

- Moderately hydrophobic; Offers comparable carbon load as most other commercially available C8 columns and faster mass transfer than SAM O-series.
- Excellent peak symmetry; highly versatile
- Offers very good selectivity for polar and moderately non-polar pharmaceuticals and biomolecules.

EliteC8 Columns are available in 5 and 10 μm particle size and 100Å pore size

Typical Column Specification:	SAM EliteC8 - Columns
5 μm Silica	100Å
Surface Area [m^2/g]	340
% Carbon	8
Coverage [moles/m^2]	7.3



Ordering Information

SMT EliteC8-5 5 μm , 100Å

* Column Dimension (length x i.d.)

50mmx4.6mm
75mmx4.6mm
100mmx4.6mm
150mmx4.6mm
250mmx4.6mm
300mmx4.6mm

* Column Dimension (length x i.d.)

50mmx3.9mm
75mmx3.9mm
100mmx3.9mm
150mmx3.9mm
250mmx3.9mm
300mmx3.9mm

SMT EliteC8-10 10 μm , 100Å

* Column Dimension (length x i.d.)

50mmx4.6mm
75mmx4.6mm
100mmx4.6mm
150mmx4.6mm
250mmx4.6mm
300mmx4.6mm

* Column Dimension (length x i.d.)

50mmx3.9mm
75mmx3.9mm
100mmx3.9mm
150mmx3.9mm
250mmx3.9mm
300mmx3.9mm

Catalog Number

EliteC8-5-100/5
EliteC8-5-100/7.5
EliteC8-5-100/10
EliteC8-5-100/15
EliteC8-5-100/25
EliteC8-5-100/30

Catalog Number

EliteC8-5-100/54
EliteC8-5-100/7.54
EliteC8-5-100/104
EliteC8-5-100/154
EliteC8-5-100/254
EliteC8-5-100/304

Catalog Number

EliteC8-10-100/5
EliteC8-10-100/7.5
EliteC8-10-100/10
EliteC8-10-100/15
EliteC8-10-100/25
EliteC8-10-100/30

Catalog Number

EliteC8-10-100/54
EliteC8-10-100/7.54
EliteC8-10-100/104
EliteC8-10-100/154
EliteC8-10-100/254
EliteC8-10-100/304

*Guard column: 20mmx4.0mm; add suffix G to Catalog Number

+Other dimensions available; Please contact SMT, Inc. for quotation

Antihistaminics: Cyclizine and Chlorcyclizine

Column: EliteC8-5-100/104

Solutes: 1=Cyclizine

2=Chlorcyclizine

Eluent: ACN: 0.01M Sodium 1-heptanesulfonate in Water (30:70)

Flow: 1.0 mL/min

Detector: UV, 230nm

Temp: 30°C

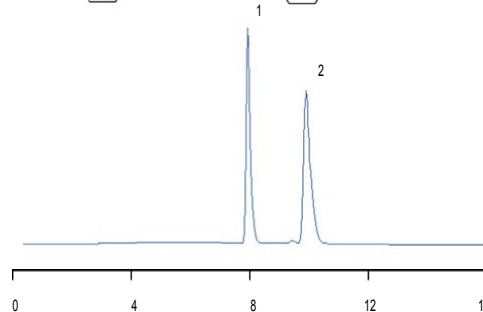
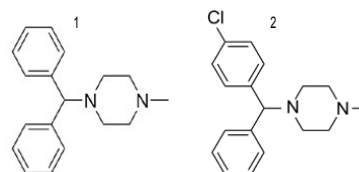

Applications of SMT EliteC8 Columns

Antioxidants

Column: EliteC8-5-100/10
Solutes: 1=butylated hydroxyanisole
2=butylated hydroxytoluene
Eluent: ACN: Water 65:35 (v:v)
Flow: 1.0 mL/min
Detector: UV; 254nm
Temp: 30°C

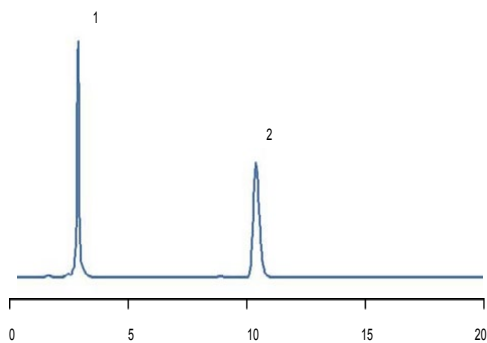

Drug molecules: AZT

Column: EliteC8-5-100/15
Solutes: 1=AZT-monophosphate
2=AZT-glucuronide
3=AZT
Eluent: ACN: 0.01% H₂PO₄ 20:80 (v:v)
Flow: 1.0 mL/min
Detector: UV; 254nm
Temp: 30°C

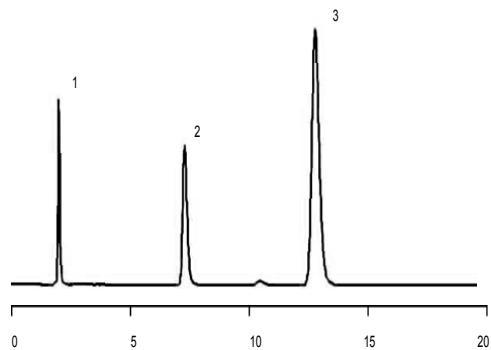

Antiarrhythmic Drugs

Column: EliteC8-5-100/15
Solutes: 1=procainamide
2=N-acetylprocainamide
Eluent: ACN: 0.025M pH=3, 10:90 (v:v)
Flow: 1.0 mL/min
Detector: UV; 254nm
Temp: 30°C

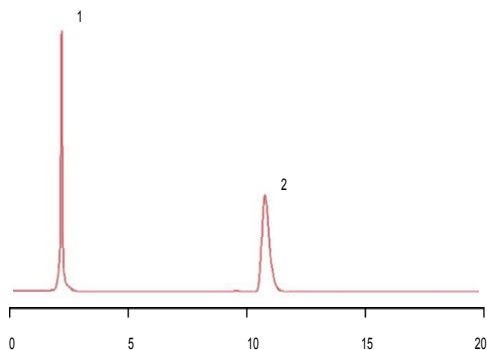

Herbicides

Column: EliteC8-5-100/15
Solutes: 1=tebuthiuron
2=simazine
3=altrazine
4=propazine
5=dactholl
Eluent: ACN: Water 60 to 100% in 5 min
Flow: 1.0 mL/min
Detector: UV; 254nm
Temp: 30°C

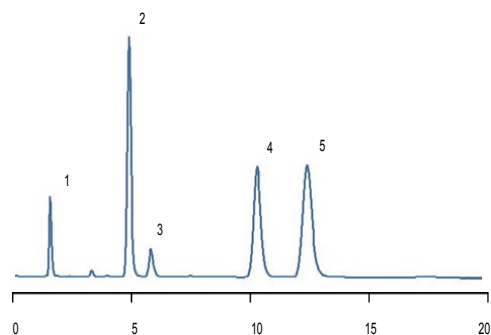

Introduction to SMT MEB Columns & Packings

Reversed-phase HPLC has been a valuable tool for the separation of variety of molecules including organics, pharmaceuticals, drugs, biomolecules, and natural products. Most analyses are performed using long-chain C18 and C8. These bonded phases are very popular because of their ruggedness and stability in generally harsh mobile phase environments. However, extended separation time and low efficiency have also been observed in many molecules of interest. For example, in separation involving biomolecules such as hydrophobic proteins, excessive hydrophobic interaction may actually result in denaturing of the proteins.

SMT manufactures columns with short carbon chains for rapid analysis of basic, neutral, and mildly acidic drugs and small molecules and biomolecules. These columns provide excellent baseline resolution for small basic molecules including therapeutic drugs. The bonding scheme ensures proper deactivation substrate silanols and resistance to acid hydrolysis.

MEB (Methyl, Ethyl, and Butyl) columns are particularly superior to other reversed-phases in the separation of compounds that show very strong hydrophobic interaction with hydrophobic stationary phases such as C18 and C8. MEB columns offers extremely fast mass transfer and high efficiency in the separation of these compounds. Specific applications include separation of proteins, peptides and food additives.

SMT offers 3 different MEB phases of varying carbon loads for optimal selectivity

MEB1 series: SMT MEB column with the shortest carbon length. The functional ligand is methyl, C1 with carbon analysis results of about 1% carbon load. In these series, a very high density of the functional ligand, methyl molecule or C1, is achieved through a novel method of molecular assembly that ensures maximum coverage of the short chain. These phases are the least hydrophobic of all the MEB columns.

MEB2 series: SMT MEB column with only two carbon chains. The functional ligand is ethyl, C2 with carbon analysis results of 2% carbon load. In these series, a very high density of the functional ligand, ethyl molecule or C2, is achieved through a novel method of molecular assembly that ensures maximum coverage. These phases offer medium hydrophobicity when compared with all the other MEB phases.

MEB4 series: SMT MEB column with four carbon chains. The functional ligand is butyl, C4 with carbon analysis results of about 4% carbon load. In these series, a very high density of the functional ligand, butyl molecule or C4, is achieved through a novel method of molecular assembly that ensures maximum coverage. These phases offer the highest hydrophobicity when compared with all the other MEB phases.

All SMT MEB packing materials are available for preparatory, solid phase extraction and process scale applications. Please refer to our bulk packing materials catalog for various particle sizes available for your application.

Hydrophobic Compounds:

Comparison of C1, C2 and C4 columns

Column: A=MEB1-5-300/15
B=MEB2-5-300/15
C=MEB4-5-300/15

Solutes: 1=Uracil
2=Benzene
3=Hexanophenone
4=Anthracene

Eluent: ACN: 40%Water: 60% ACN
Flow: 1.0 mL/min
Detector: UV; 254nm
Temp: 30°C

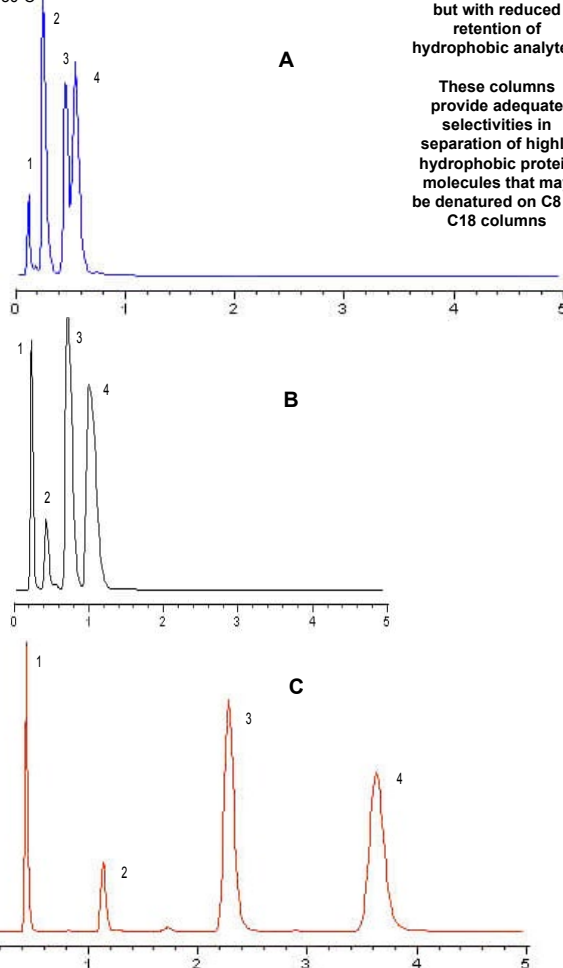

MEB columns usually offer similar selectivities as C8 but with reduced retention of hydrophobic analytes.

These columns provide adequate selectivities in separation of highly hydrophobic protein molecules that may be denatured on C8 or C18 columns

SMT MEB1 [C1] Columns & Applications

Special features:

- SMT MEB phase with the least hydrophobicity; the functional ligand density provides only about 1% carbon load on the silica substrate.
- Offers selectivity for polar and nonpolar pharmaceuticals, natural products, very hydrophobic proteins and biomolecules.
- Longer column lifetime than traditional C1 columns.

MEB1-Columns are available in various particle and pore sizes: 5, 10 µm and 100, 300Å are stock sizes.

Typical Column Specification:	MEB1-Columns	
5 µm Silica	100Å	300Å
Surface Area [m ² /g]	340	90
% Carbon	1	0.6
Coverage [moles/m ²]	7.3	7.2

Ordering Information

SMT MEB1 - Columns 5 µm, 100Å

* Column Dimension (length x i.d.)

30mmx4.6mm
50mmx4.6mm
75mmx4.6mm
100mmx4.6mm
150mmx4.6mm
250mmx4.6mm
300mmx4.6mm

Catalog Number

MEB1-5-100/3
MEB1-5-100/5
MEB1-5-100/7.5
MEB1-5-100/10
MEB1-5-100/15
MEB1-5-100/25
MEB1-5-100/30

* Column Dimension (length x i.d.)

30mmx3.9mm
50mmx3.9mm
75mmx3.9mm
100mmx3.9mm
150mmx3.9mm
250mmx3.9mm
300mmx3.9mm

Catalog Number

MEB1-5-100/34
MEB1-5-100/54
MEB1-5-100/7.54
MEB1-5-100/104
MEB1-5-100/154
MEB1-5-100/254
MEB1-5-100/304

SMT MEB1 - Columns 5 µm, 300Å

* Column Dimension (length x i.d.)

30mmx4.6mm
50mmx4.6mm
75mmx4.6mm
100mmx4.6mm
150mmx4.6mm
250mmx4.6mm
300mmx4.6mm

Catalog Number

MEB1-5-300/3
MEB1-5-300/5
MEB1-5-300/7.5
MEB1-5-300/10
MEB1-5-300/15
MEB1-5-300/25
MEB1-5-300/30

* Column Dimension (length x i.d.)

30mmx3.9mm
50mmx3.9mm
75mmx3.9mm
100mmx3.9mm
150mmx3.9mm
250mmx3.9mm
300mmx3.9mm

Catalog Number

MEB1-5-300/34
MEB1-5-300/54
MEB1-5-300/7.54
MEB1-5-300/104
MEB1-5-300/154
MEB1-5-300/254
MEB1-5-300/304

*Guard column: 20mmx4.0mm; add suffix G to Catalog Number

+Other dimensions available; Please contact SMT, Inc. for quotation



Therapeutic Drugs: Biaxin®

Column: MEB1-5-100/5
Solute: 1 = unknown
 2 = Clarithromycin
Eluent: ACN: 0.01M ammonium formate buffer 90:10 (v:v)
Flow: 1.0 mL/min
Detector: UV; 280nm
Temp: 30°C

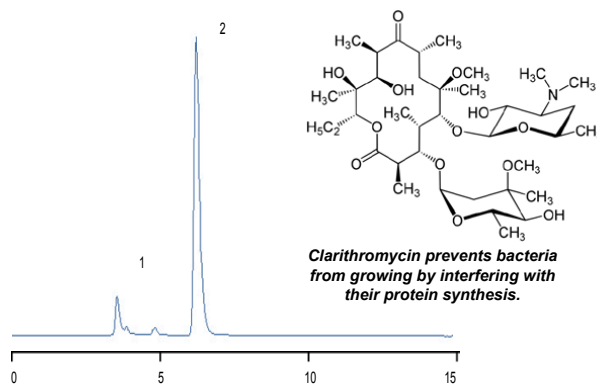

Hydrophobic Protein: bacterio-opsin

Column: MEB1-5-100/5
Solute: 1=bacterio-opsin
Eluent: 0.02% TFA Water:0.02% TFA ACN, Hold 100:0 (v:v)
 5 mins then gradient to 60:40 (v:v) in 10 mins
Flow: 1.0 mL/min
Detector: UV; 220nm
Temp: 30°C

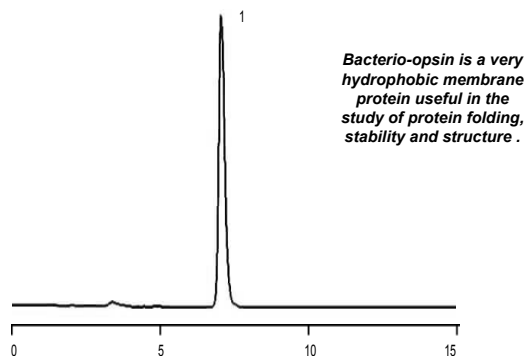

SMT MEB2 [C2] Columns and Applications

Special features:

- SMT MEB phase with the least hydrophobicity; the functional ligand density provides only about 1% carbon load on the silica substrate.
- Offers selectivity for polar and nonpolar pharmaceuticals, natural products, very hydrophobic proteins and biomolecules.
- Longer column lifetime than traditional C1 columns.

MEB2-Columns are available in various particle and pore sizes: 5, 10 µm and 100, 300Å are stock sizes.



Typical Column Specification:	MEB2-Columns	
5 µm Silica	100Å	300Å
Surface Area [m ² /g]	340	90
% Carbon	1.2	0.6
Coverage [moles/m ²]	7.3	7.2

Ordering Information

SMT MEB2 - Columns 5 µm, 100Å

* Column Dimension (length x i.d.)

30mmx4.6mm
50mmx4.6mm
75mmx4.6mm
100mmx4.6mm
150mmx4.6mm
250mmx4.6mm
300mmx4.6mm

Catalog Number
MEB2-5-100/3
MEB2-5-100/5
MEB2-5-100/7.5
MEB2-5-100/10
MEB2-5-100/15
MEB2-5-100/25
MEB2-5-100/30

* Column Dimension (length x i.d.)

30mmx3.9mm
50mmx3.9mm
75mmx3.9mm
100mmx3.9mm
150mmx3.9mm
250mmx3.9mm
300mmx3.9mm

Catalog Number
MEB2-5-100/34
MEB2-5-100/54
MEB2-5-100/7.54
MEB2-5-100/104
MEB2-5-100/154
MEB2-5-100/254
MEB2-5-100/304

SMT MEB2 - Columns 5 µm, 300Å

* Column Dimension (length x i.d.)

30mmx4.6mm
50mmx4.6mm
75mmx4.6mm
100mmx4.6mm
150mmx4.6mm
250mmx4.6mm
300mmx4.6mm

Catalog Number
MEB2-5-300/3
MEB2-5-300/5
MEB2-5-300/7.5
MEB2-5-300/10
MEB2-5-300/15
MEB2-5-300/25
MEB2-5-300/30

* Column Dimension (length x i.d.)

30mmx3.9mm
50mmx3.9mm
75mmx3.9mm
100mmx3.9mm
150mmx3.9mm
250mmx3.9mm
300mmx3.9mm

Catalog Number
MEB2-5-300/34
MEB2-5-300/54
MEB2-5-300/7.54
MEB2-5-300/104
MEB2-5-300/154
MEB2-5-300/254
MEB2-5-300/304

*Guard column: 20mmx4.0mm; add suffix G to Catalog Number
*Other dimensions available; Please contact SMT, Inc. for quotation

Biomolecules: Laccase

Column: **A= MEB2-5-300/15**
Solutes: 1= Laccase
2= unknown
Eluent: 0.02% TFA Water:0.02% TFAACN, Hold 100:0 (v:v)
5 mins then gradient to 60:40 (v:v) in 10 mins
Flow: 1.0 mL/min
Detector: UV; 215nm
Temp: 30°C

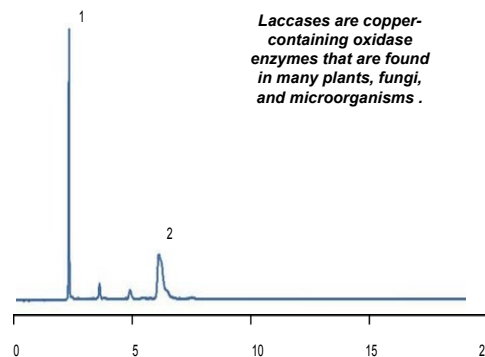

Laccases are copper-containing oxidase enzymes that are found in many plants, fungi, and microorganisms.

Drug: Zantac®

Column: **MEB2-5-100/15**
Solutes: 1=ranitidine HCL
Eluent: ACN: 0.01M TEA in H₃PO₄ [pH=3] 30:70
Flow: 1.0 mL/min
Detector: UV; 315nm
Temp: 30°C

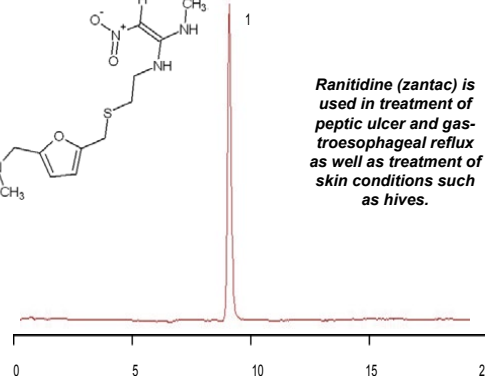
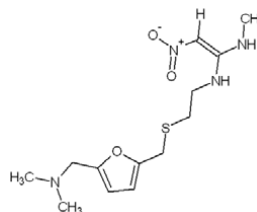

Ranitidine (zantac) is used in treatment of peptic ulcer and gastroesophageal reflux as well as treatment of skin conditions such as hives.

SMT MEB4 [C4] Columns & Applications

Special features:

- SMT MEB phase with four carbon chains. The functional ligand density provides about 3% carbon load on the silica substrate.
- Most hydrophobic of all MEB columns; designed to tolerate mildly aggressive pH conditions that may hamper usage life of MEB1 and MEB2 columns.
- Excellent peak symmetry; offers very good selectivity for polar and moderately nonpolar pharmaceuticals and biomolecules.
- Longer column lifetime than traditional C4 columns.
- Virtually no nonspecific adsorption of proteins

MEB4-Columns are available in various particle and pore sizes: 5, 10 μm and 100, 300 \AA are stock sizes.

Typical Column Specification:	MEB4-Columns	
5 μm Silica	100 \AA	300 \AA
Surface Area [m^2/g]	340	90
% Carbon	5.2	3.4
Coverage [moles/m^2]	7.3	7.2

Ordering Information

SMT MEB4 - Columns 5 μm , 100 \AA

* Column Dimension (length x i.d.)

30mmx4.6mm
50mmx4.6mm
75mmx4.6mm
100mmx4.6mm
150mmx4.6mm
250mmx4.6mm
300mmx4.6mm

Catalog Number

MEB4-5-100/3
MEB4-5-100/5
MEB4-5-100/7.5
MEB4-5-100/10
MEB4-5-100/15
MEB4-5-100/25
MEB4-5-100/30

* Column Dimension (length x i.d.)

30mmx3.9mm
50mmx3.9mm
75mmx3.9mm
100mmx3.9mm
150mmx3.9mm
250mmx3.9mm
300mmx3.9mm

Catalog Number

MEB4-5-100/34
MEB4-5-100/54
MEB4-5-100/7.54
MEB4-5-100/104
MEB4-5-100/154
MEB4-5-100/254
MEB4-5-100/304

SMT MEB4 - Columns 5 μm , 300 \AA

* Column Dimension (length x i.d.)

30mmx4.6mm
50mmx4.6mm
75mmx4.6mm
100mmx4.6mm
150mmx4.6mm
250mmx4.6mm
300mmx4.6mm

Catalog Number

MEB4-5-300/3
MEB4-5-300/5
MEB4-5-300/7.5
MEB4-5-300/10
MEB4-5-300/15
MEB4-5-300/25
MEB4-5-300/30

* Column Dimension (length x i.d.)

30mmx3.9mm
50mmx3.9mm
75mmx3.9mm
100mmx3.9mm
150mmx3.9mm
250mmx3.9mm
300mmx3.9mm

Catalog Number

MEB4-5-300/34
MEB4-5-300/54
MEB4-5-300/7.54
MEB4-5-300/104
MEB4-5-300/154
MEB4-5-300/254
MEB4-5-300/304

*Guard column: 20mmx4.0mm; add suffix G to Catalog Number
*Other dimensions available; Please contact SMT, Inc. for quotation



Hydrophobic Protein: Collagen

Column: MEB4-5-300/15
Solutes: 1= collagen
Eluent: A=0.05% TFA/water B=0.05% TFA/ACN;
A:B (20:80) to A:B (80:20) in 10 min
Flow: 1.0 mL/min
Detector: UV; 220nm
Temp: 30°C

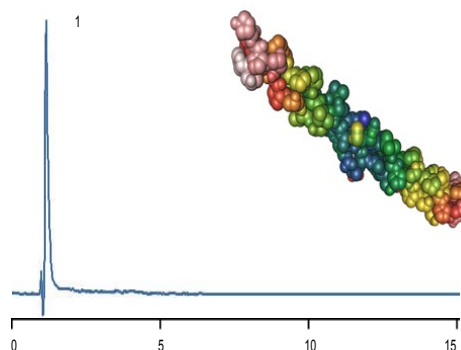

Protein molecules: Insulin variants

Column: MEB4-5-300/25
Solutes: 1=Chicken Insulin
2=Bovine Insulin
3=Rabbit Insulin
4=Human Insulin
5=Porcine Insulin
Eluent: A: 0.05% TFA-water B=0.05% TFA-ACN
20-40% B in 20 min
Flow: 1.0 mL/min
Detector: UV; 220nm
Temp: 30°C

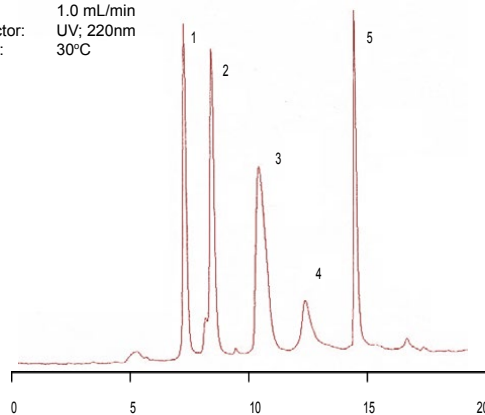

SMT Phenyl Columns

SMT Phenyl column provides unique selectivity for aromatic compounds when compared to other reversed-phase packings such as C18 and C8. The π -electrons of the phenyl group can interact with the aromatic ring of an analyte to increase retention relative to less or non-aromatic analytes.

Special features:

- Offers preferential retention of aromatic compounds.
- Complimentary to other reversed-phase materials such as C18, C8, and C4.

Three types of SMT Phenyl are available:

- **Phen1**: contains one phenyl per ligand
- **Phen2**: contains two phenyls per ligand
- **PhenH**: contains phenyl-hexyl chain configuration

SMT Phenyl columns are also ideal for the separation of proteins, peptides and other biomolecules. PhenH has an extended alkyl chain (hexyl) configuration that impacts a unique mixed mode characteristics on the phenyl column. Figure 1 shows a comparison of a typical selectivity obtainable in the separation of a mixture containing aliphatic and aromatic compounds using of SMT-Phen1, SMT-Phen2 and SMT-C18 columns.



SMT Phenyl-Columns are available in various particle and pore sizes: 5, 10 μm and 100, 300 \AA are stock sizes.

Typical Column Specification:	SAM Phen1-Columns		SAM Phen2-Columns	
5 μm Silica	100 \AA	300 \AA	100 \AA	300 \AA
Surface Area [m^2/g]	340	90	340	90
% Carbon	7.1	3.1	8.4	3.6
Coverage [moles/m^2]	7.2	7.2	7.2	7.2

Ordering Information

SMT Phen1 - Columns 5 μm , 100 \AA

* Column Dimension (length x i.d.)
50mmx4.6mm
150mmx4.6mm
250mmx4.6mm

Catalog Number
Phen1-5-100/5
Phen1-5-100/15
Phen1-5-100/25

SMT Phen1 - Columns 5 μm , 300 \AA

* Column Dimension (length x i.d.)
150mmx4.6mm
250mmx4.6mm

Catalog Number
Phen1-5-300/15
Phen1-5-300/25

SMT Phen1 - Columns 10 μm , 100 \AA

* Column Dimension (length x i.d.)
50mmx4.6mm
150mmx4.6mm
250mmx4.6mm

Catalog Number
Phen1-10-100/5
Phen1-10-100/15
Phen1-10-100/25

SMT Phen1 - Columns 10 μm , 300 \AA

* Column Dimension (length x i.d.)
150mmx4.6mm
250mmx4.6mm

Catalog Number
Phen1-10-300/15
Phen1-10-300/25

SMT Phen2 - Columns 5 μm , 100 \AA

* Column Dimension (length x i.d.)
50mmx4.6mm
150mmx4.6mm
250mmx4.6mm

Catalog Number
Phen2-5-100/5
Phen2-5-100/15
Phen2-5-100/25

SMT Phen2 - Columns 5 μm , 300 \AA

* Column Dimension (length x i.d.)
150mmx4.6mm
250mmx4.6mm

Catalog Number
Phen2-5-300/15
Phen2-5-300/25

SMT Phen2 - Columns 10 μm , 100 \AA

* Column Dimension (length x i.d.)
50mmx4.6mm
150mmx4.6mm
250mmx4.6mm

Catalog Number
Phen2-10-100/5
Phen2-10-100/15
Phen2-10-100/25

SMT Phen2 - Columns 10 μm , 300 \AA

* Column Dimension (length x i.d.)
150mmx4.6mm
250mmx4.6mm

Catalog Number
Phen2-10-300/15
Phen2-10-300/25

*Guard column: 20mmx4.0mm; add suffix G to Catalog Number
+Other dimensions available; Please contact SMT, Inc. for quotation

Steroids

Column: SMT Phenyls vs SMT C18

Solutes: 1=prednisolone
2=hydrocortisone
3=cortisone
4=progesterone

Eluent: Methanol: Water (60:40)
Flow: 1.0 mL/min
Detector: UV; 254nm
Temp: 30°C

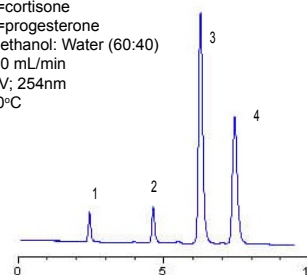

Phen1-5-100/15

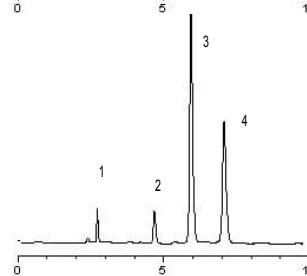

Phen2-5-100/15

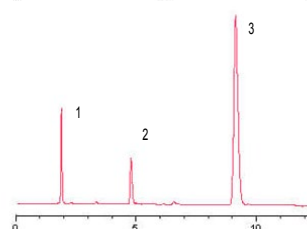

OD-5-100/15

SMT Phenyl-Hexyl Columns

SMT Phenyl-Hexyl column or PhenH column, like the other SMT Phenyl columns, provides unique selectivity for aromatic compounds when compared to other reversed-phase packings such as C18 and C8. The π -electrons of the phenyl group can interact with the aromatic ring of an analyte to increase retention relative to less or non-aromatic analytes. Phenyl-Hexyl columns provide unique selectivity for aromatic compounds when compared to other reversed-phase packings such as C18 and C8. Unlike the standard Phenyl column, Phenyl-Hexyl allows much greater retention and separation of the aromatic compounds through its extended hexyl hydrocarbon functional group.

Typical Column Specification: SAM PhenH-Columns

5 μm Silica	100Å	300Å
Surface Area [m^2/g]	340	90
% Carbon	7.1	3.1
Coverage [moles/m^2]	7.2	7.2

SMT PhenH-Columns are available in various particle and pore sizes: 3, 5, 10 μm and 100, 300Å are stock sizes.

Ordering Information

SMT PhenH - Columns 3 μm , 100Å

* Column Dimension (length x i.d.)
50mmx4.6mm
100mmx4.6mm
150mmx4.6mm

Catalog Number
PhenH-3-100/5
PhenH-3-100/10
PhenH-3-100/15

SMT PhenH - Columns 5 μm , 100Å

* Column Dimension (length x i.d.)
50mmx4.6mm
100mmx4.6mm
150mmx4.6mm
250mmx4.6mm

Catalog Number
PhenH-5-100/5
PhenH-5-100/10
PhenH-5-100/15
PhenH-5-100/25

SMT PhenH - Columns 5 μm , 300Å

* Column Dimension (length x i.d.)
50mmx4.6mm
100mmx4.6mm
150mmx4.6mm
250mmx4.6mm

Catalog Number
PhenH-5-300/5
PhenH-5-300/10
PhenH-5-300/15
PhenH-5-300/25

SMT PhenH - Columns 10 μm , 100Å

* Column Dimension (length x i.d.)
50mmx4.6mm
100mmx4.6mm
150mmx4.6mm
250mmx4.6mm

Catalog Number
PhenH-10-100/5
PhenH-10-300/5
PhenH-10-300/10
PhenH-10-300/15
PhenH-10-100/25

SMT PhenH - Columns 10 μm , 300Å

* Column Dimension (length x i.d.)
50mmx4.6mm
100mmx4.6mm
150mmx4.6mm
250mmx4.6mm

Catalog Number
PhenH-10-300/5
PhenH-10-300/10
PhenH-10-300/15
PhenH-10-300/25

*Guard column: 20mmx4.0mm; add suffix G to Catalog Number

+Other dimensions available; Please contact SMT, Inc. for quotation

Special features:

- Offers mixed-mode characteristics for preferential retention of aromatic compounds through its extended alkyl chain.
- Complimentary to other reversed-phase materials such as C18, C8, and C4.
- Ideal for the separation of proteins, peptides and other biomolecules.

SMT PhenH has an extended alkyl chain (hexyl) configuration that impacts a unique mixed mode characteristics on the phenyl column. Figure 1 shows a comparison of a typical selectivity obtainable in the separation of a mixture containing aliphatic and aromatic compounds using of SMT-Phen1, SMT-Phen2 and SMT-PhenH columns.

Aromatic compounds: Steroids

Column: PhenH-5-100/15 vs Phen1-5-100/15

Solutes:
1=prednisolone
2=hydrocortisone
3=cortisone
4=progesterone

Eluent: Methanol: Water (60:40)

Flow: 1.0 mL/min

Detector: UV; 254nm

Temp: 30°C

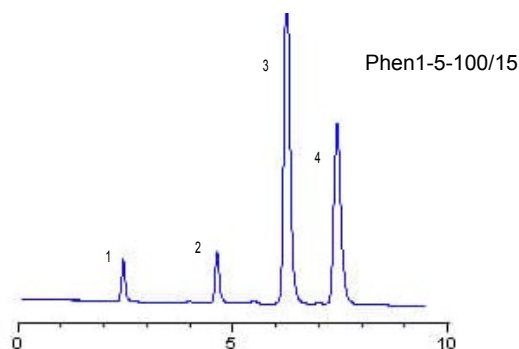
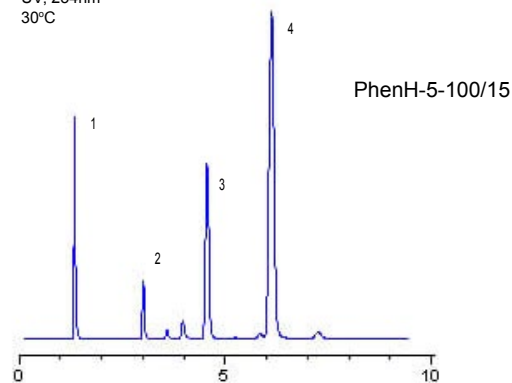

Normal Phase Chromatography

When chromatographic separation is done in a normal phase mode, the surface chemistry of the stationary phase has a polar characteristic. The mobile phase is generally nonpolar organic solvent (such as hexane or heptane). Because of the limited flexibility in variation of the mobile phase polarity and functional stationary phase, separation in normal phase mode has not grown as much as reversed-phase mode. However, continuous advancement in surface modification has rejuvenated interest in normal phase chromatography. Furthermore, there are some separations that are achieved more conveniently using normal mode.

Silica, alumina, polymers, and a few other metal oxides are the most favorite substrates for normal phase separation. The important features include high surface area, availability in high purity, and homogeneous functional groups.

Generally, SMT normal phase columns consist of silica as the substrate. SMT also offers a series of specialty packing materials for various applications including alumina and magnesia-silica. When used as separation media, attention must be paid to the following characteristics of these packing materials:

1. Shape: Spherical or Irregular

Most packings used for analytical scale separation are best done with spherical particles for reproducibility and reduction of column back pressure. Furthermore, the particle sphericity can provide the column with high mechanical stability. However, irregular packings, which are usually less expensive, may be just as suitable in some analytical applications. Irregular packings are particularly suitable for low-pressure large and process scale including solid phase extraction and flash applications.

2. Porosity: Narrow or Wide

The smaller pore size packings provide higher surface area for greater sample loading. However, the small pore size may exclude large molecules from adequate partitioning over its surface, and as such, may not be ideal for separation of large molecules. Furthermore, the large surface area offered by these packings may result in excessive retention of some analytes of interest. Wide pore size particles generally have low surface area that may be more suitable for the separation of large molecules.

3. Purity

Most packings used for analytical scale separation are best done with particles of high purity for reproducibility and to provide complete sample recovery needed in these applications. The absence of impurities reduces non-specific sample adsorption which can lower sample recovery and cause unusual peak shapes.

4. Particle size

Columns used for analytical scale separation are packed with particles ranging from 3 to 10 μm ; the most preferred particle size is 5 μm . Columns packed with smaller particle size result in better resolution of analytes; however, the columns have higher back-pressure. The new trend columns for Ultra High Pressure Liquid Chromatography (UHPLC), are packed with particles below 2 μm and generate pressure in excess of 10,000 psi.

Structure of Silica gel used in HPLC

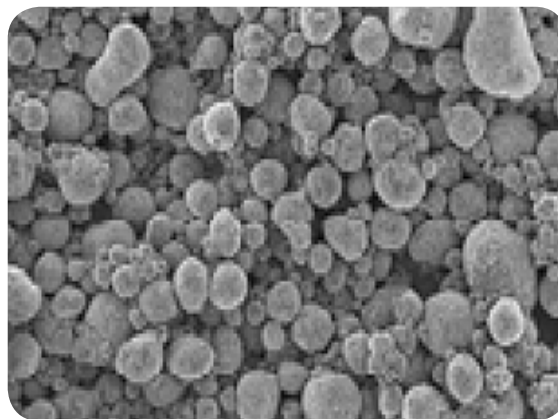
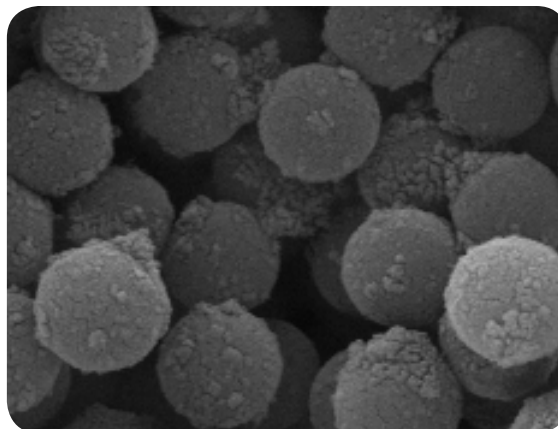
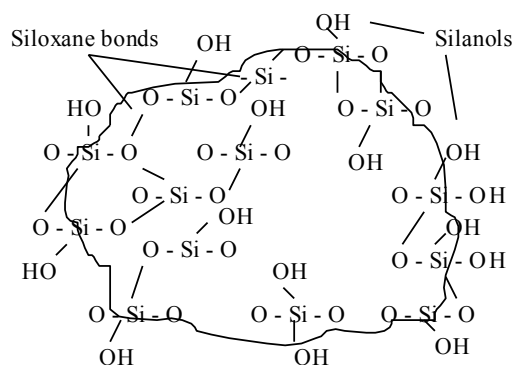

SMT Silica [S] Columns & Applications

When silica is used as the stationary phase, the functional groups involved in separation are the surface silanols. However, metal impurities in silica may provide additional sites of interaction for solutes of interest. SMT uses high purity silica packing materials that are available in variety of particle and pore sizes. These columns have performed well in the separation of many polar compounds such as pesticides and organic acids.

Special features:

- Ultra pure silica
- High reproducibility batch to batch resulting in consistent separation

Typical Column Specification:	S-Columns	
5 µm Silica	100Å	300Å
Surface Area [m ² /g]	340	90
Pore volume [ml/g]	8.1	3.4
Particle Shape	Spherical	Spherical
Chemical Purity [Na, Al, Fe, etc.]	<25ppm	<20ppm
Chemical Stability	pH (1.5-9.5)	pH (1.5-9.0)
Mechanical Stability	10,000 psi	8,000 psi

Ordering Information

SMT S - Columns 3 µm, 100Å

* Column Dimension (length x i.d.)
 50mmx4.6mm
 100mmx4.6mm
 150mmx4.6mm
 250mmx4.6mm

Catalog Number
 S-3-100/5
 S-3-100/10
 S-3-100/15
 S-3-100/25

SMT S - Columns 5 µm, 100Å

* Column Dimension (length x i.d.)
 50mmx4.6mm
 100mmx4.6mm
 150mmx4.6mm
 250mmx4.6mm
 300mmx4.6mm

Catalog Number
 S-5-100/5
 S-5-100/10
 S-5-100/15
 S-5-100/25
 S-5-100/30

SMT S - Columns 10 µm, 100Å

* Column Dimension (length x i.d.)
 50mmx4.6mm
 100mmx4.6mm
 150mmx4.6mm
 250mmx4.6mm
 300mmx4.6mm

Catalog Number
 S-10-100/5
 S-10-100/10
 S-10-100/15
 S-10-100/25
 S-10-100/30

SMT S - Columns 5 µm, 300Å

* Column Dimension (length x i.d.)
 50mmx4.6mm
 100mmx4.6mm
 150mmx4.6mm
 250mmx4.6mm
 300mmx4.6mm

Catalog Number
 S-5-300/5
 S-5-300/10
 S-5-300/15
 S-5-300/25
 S-5-300/30

SMT S - Columns 10 µm, 300Å

* Column Dimension (length x i.d.)
 50mmx4.6mm
 100mmx4.6mm
 150mmx4.6mm
 250mmx4.6mm
 300mmx4.6mm

Catalog Number
 S-10-300/5
 S-10-300/10
 S-10-300/15
 S-10-300/25
 S-10-300/30

SMT S - Columns 5 µm, 60Å

* Column Dimension (length x i.d.)
 150mmx4.6mm
 250mmx4.6mm
 300mmx4.6mm

Catalog Number
 S-5-60/15
 S-5-60/25
 S-5-60/30

*Guard column: 20mmx4.0mm; add suffix G to Catalog Number
 +Other dimensions available; Please contact SMT, Inc. for quotation

S-columns are available in various particle and pore sizes: 3, 5, 10 µm ; 100, 300Å are stock sizes.



Separation of Pesticides

Column: S-5-100/10

Solutes: 1=prometryn
 2=terbutryn
 3=ametryn
 4=atrazine

Eluent: Hexane: Methanol 98:2

Flow: 1.0 mL/min

Detector: UV; 220nm

Temp: 30°C

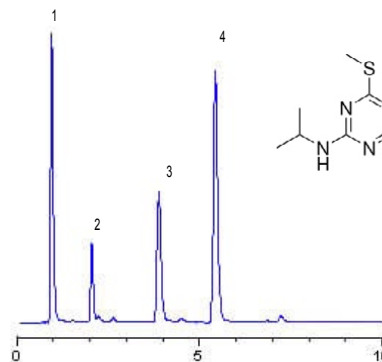

Separation of Tocopherols

Column: S-5-100/15

Solutes: 1=alpha-tocopherol
 2=beta-tocopherol
 3=gama-tocopherol
 4=delta-tocopherol

Eluent: Hexane: THF: Acetic acid (96:4/0.25)

Flow: 1.0 mL/min

Detector: UV; 295nm

Temp: 30°C

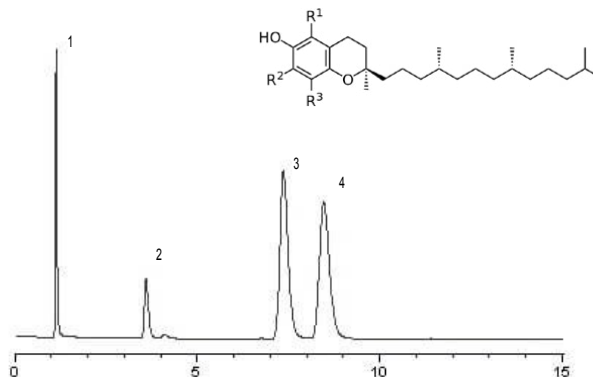

SMT DIOL Columns & Applications

SMT Diol column is developed as an alternative for silica column used in normal phase separation methods. The Diol [-OH] functional group is controlled, and as such, provides more reproducible separation when compared to separation on silanols [-OH] from bare silica surface. Furthermore, the hydrogen bonding on the OH functional group on Diol packing material is not as strong as that of bare silica. This results in a reduced interaction of polar compounds on the column. SMT Diol can be used in normal and reversed-phase separation of pesticides, herbicides, pharmaceutical metabolites, polar natural products, proteins, peptides and other polar biomolecules.

Special features:

- High loading capability and improved sample recovery
- High reproducibility of bonded ligand resulting in consistent separation.
- Increased longevity provided through "total coverage™".

SMT offers two types of Diol columns:

- **Diol1** columns-consist of acid-catalyzed cleavage of 3-(2,3-epoxypropoxy) propyl or 3-Glycidoxypropyl as the functional ligand
- **Diol2** columns-consist of acid-catalyzed cleavage of 5,6-epoxyhexyl as the functional ligand.

Just like the silica substrate, both of these packings can be subjected to further treatment or modification with another functional ligand for special applications. SMT Diol1 is particularly suitable for immobilization of biomolecules such as Protein-A, IgG, haptoglobin, etc.; Diol1 is available in bulk for affinity-based separation techniques because of these features.

Separation of Polar compounds

Column: **A=S-5-100/25**
B=Diol1-5-100/25
C=Diol2-5-100/25

Solutes: 1=phenol
2=catechol
3=resorcinol
4=hydroquinone

Eluent: Isooctane: Ethanol (80:20)
Flow: 2.0 mL/min
Detector: UV; 254nm
Temp: 30°C

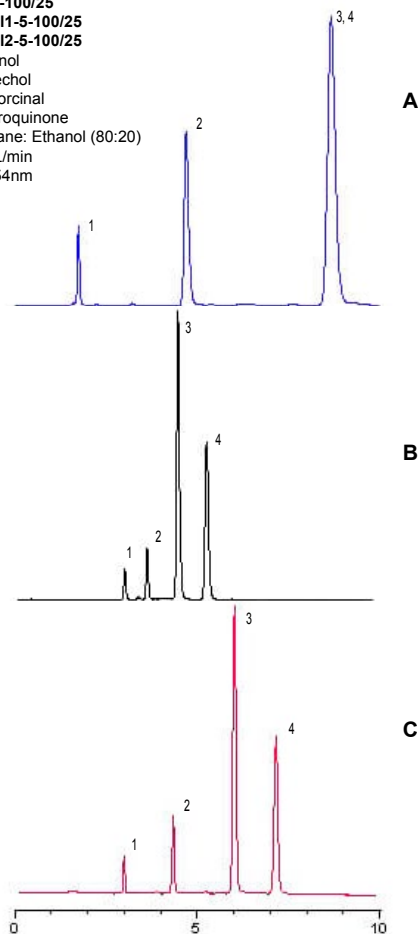

Typical Column Specification:	SAM Diol1-Columns		SAM Diol2-Columns	
5 µm Silica	100Å	300Å	100Å	300Å
Surface Area [m ² /g]	340	90	340	90
% Carbon	6.5	3.2	6.2	3.1
Coverage [moles/m ²]	7.2	7.2	7.2	7.2

Ordering Information

SMT DIOL1 - Columns 5 µm, 100Å

* Column Dimension (length x i.d.)

50mmx4.6mm
100mmx4.6mm
150mmx4.6mm
250mmx4.6mm

Catalog Number
DIOL1-5-100/5
DIOL1-5-100/10
DIOL1-5-100/15
DIOL1-5-100/25

SMT DIOL1 - Columns 5 µm, 300Å

* Column Dimension (length x i.d.)

150mmx4.6mm
250mmx4.6mm

Catalog Number
DIOL1-5-300/15
DIOL1-5-300/25

SMT DIOL1 - Columns 10 µm, 100Å

* Column Dimension (length x i.d.)

150mmx4.6mm
250mmx4.6mm

Catalog Number
DIOL1-10-100/15
DIOL1-10-100/25

SMT DIOL1 - Columns 10 µm, 300Å

* Column Dimension (length x i.d.)

150mmx4.6mm
250mmx4.6mm

Catalog Number
DIOL1-10-300/15
DIOL1-10-300/25

SMT DIOL2 - Columns 5 µm, 100Å

* Column Dimension (length x i.d.)

50mmx4.6mm
100mmx4.6mm
150mmx4.6mm
250mmx4.6mm

Catalog Number
DIOL2-5-100/5
DIOL2-5-100/10
DIOL2-5-100/15
DIOL2-5-100/25

SMT DIOL2 - Columns 5 µm, 300Å

* Column Dimension (length x i.d.)

150mmx4.6mm
250mmx4.6mm

Catalog Number
DIOL2-5-300/15
DIOL2-5-300/25

SMT DIOL2 - Columns 10 µm, 100Å

* Column Dimension (length x i.d.)

150mmx4.6mm
250mmx4.6mm

Catalog Number
DIOL2-10-100/15
DIOL2-10-100/25

SMT DIOL2 - Columns 10 µm, 300Å

* Column Dimension (length x i.d.)

150mmx4.6mm
250mmx4.6mm

Catalog Number
DIOL2-10-300/15
DIOL2-10-300/25

SMT Aminopropyl [NH₂] Columns

SMT manufactures very stable NH₂ columns. SMT NH₂ columns are often recommended for the separation of polar compounds and can be used in three separation modes:

- Normal
- Weakly Anion Exchange
- Reversed-Phase

In normal phase mode, the columns can be used to separate polar compounds such as substituted anilines, phenols, and chlorinated pesticides. In reversed-phase mode, separation of organic acids and anions is possible with the addition of common buffers. Other applications include reversed-phase separation of carbohydrates in food and beverages.

NH₂-Columns are available in various particle and pore sizes: 5 and 10µm; 100 and 300Å are stock sizes.

Typical Column Specification:	NH ₂ -Columns	
5 µm Silica	100Å	300Å
Surface Area [m ² /g]	340	90
% Carbon	3.1	1.6
Coverage [moles/m ²]	7.2	7.2

Ordering Information

SMT AP - Columns 5 µm, 100Å

* Column Dimension (length x i.d.)

50mmx4.6mm
100mmx4.6mm
150mmx4.6mm
250mmx4.6mm
300mmx4.6mm

Catalog Number

AP-5-100/5
AP-5-100/10
AP-5-100/15
AP-5-100/25
AP-5-100/30

SMT AP - Columns 5 µm, 300Å

* Column Dimension (length x i.d.)

50mmx4.6mm
100mmx4.6mm
150mmx4.6mm
250mmx4.6mm
300mmx4.6mm

Catalog Number

AP-5-300/5
AP-5-300/10
AP-5-300/15
AP-5-300/25
AP-5-300/30

SMT AP - Columns 10 µm, 100Å

* Column Dimension (length x i.d.)

150mmx4.6mm
250mmx4.6mm
300mmx4.6mm

Catalog Number

AP-10-100/15
AP-10-100/25
AP-10-100/30

SMT AP - Columns 10 µm, 300Å

* Column Dimension (length x i.d.)

150mmx4.6mm
250mmx4.6mm
300mmx4.6mm

Catalog Number

AP-10-300/15
AP-10-300/25
AP-10-300/30

SMT APM - Columns 5 µm, 100Å

* Column Dimension (length x i.d.)

150mmx4.6mm
250mmx4.6mm
300mmx4.6mm

Catalog Number

APM-5-100/15
APM-5-100/25
APM-5-100/30

SMT APM - Columns 10 µm, 100Å

* Column Dimension (length x i.d.)

150mmx4.6mm
250mmx4.6mm
300mmx4.6mm

Catalog Number

APM-10-100/15
APM-10-100/25
APM-10-100/30

*Guard column: 20mmx4.0mm; add suffix G to Catalog Number
*Other dimensions available; Please contact SMT, Inc. for quotation

Special features:

- Improved separation of polar solutes; excellent sample recovery; high loading capability
- High reproducibility of bonded ligand resulting in consistent separation.
- Increased longevity provided through "total coverage".

SMT offers two types of columns:

- Aminopropyl (AP-series)
- Aminopropyl Methyl (APM-series)



Separation of Carbohydrates

Column: AP-5-300/25

Solutes:
1=fructose
2=glucose
3=sucrose
4=lactose

Eluent: ACN: Water (80:20)
Flow: 1.0 mL/min
Detector: RI
Temp: 30°C

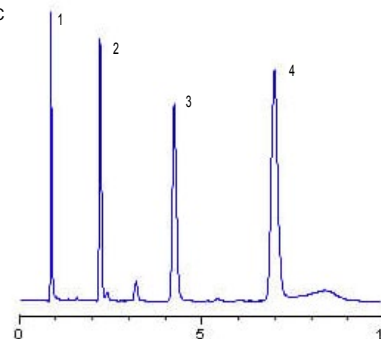

Separation of Chlorinated Pesticides

Column: AP-5-100/15

Solutes:
1=Aldrin
2=Heptachlor
3=Endrin
4=Methoxychlor

Eluent: Hexane: Methanol 97:3
Flow: 1.0 mL/min
Detector: UV; 254nm
Temp: 30°C

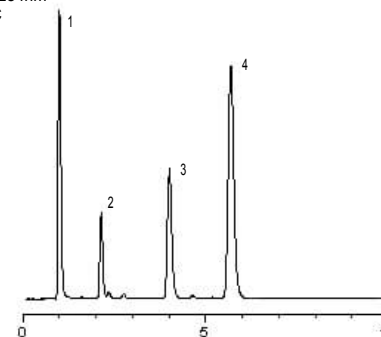

SMT Cyanopropyl [CN] Columns

SMT manufactures ultra-stable CN or CyanoPropyl (CP) columns for normal and reversed-phase chromatographic separation modes. These columns have some special characteristics:

- When used in normal phase mode, with relatively nonpolar solvents, CN-stationary phase can separate many polar compounds just like silica.
- When used in reversed-phase mode, with relatively polar solvents, CN-stationary phase offers complimentary selectivity that may be unattainable with traditional reversed-phase packings such as C18 and C8.

Special features:

- Homogeneous CN-functional surface that permits faster equilibration than unmodified hydroxyl silica surface.
- Extremely high phase density and stability that are not found in conventional CN-stationary phases.
- Increased longevity provided through "total coverage™".

Cyanopropyl [CN] -Columns are available in various particle and pore sizes: 3,5, 10µm; 100, 120 and 300Å are stock sizes.

Typical Column Specification:	CN-Columns	
5 µm Silica	100Å	300Å
Surface Area [m ² /g]	340	90
% Carbon	3.1	1.6
Coverage [moles/m ²]	7.2	7.2

Ordering Information

SMT CN - Columns 3 µm, 100Å

* Column Dimension (length x i.d.)

50mmx4.6mm
100mmx4.6mm
150mmx4.6mm

Catalog Number

CP-3-100/5
CP-3-100/10
CP-3-100/15

SMT CN - Columns 5 µm, 100Å

* Column Dimension (length x i.d.)

50mmx4.6mm
100mmx4.6mm
150mmx4.6mm
250mmx4.6mm
300mmx4.6mm

Catalog Number

CP-5-100/5
CP-5-100/10
CP-5-100/15
CP-5-100/25
CP-5-100/30

SMT CN - Columns 5 µm, 300Å

* Column Dimension (length x i.d.)

50mmx4.6mm
100mmx4.6mm
150mmx4.6mm
250mmx4.6mm
300mmx4.6mm

Catalog Number

CP-5-300/5
CP-5-300/10
CP-5-300/15
CP-5-300/25
CP-5-300/30

SMT CN - Columns 10 µm, 100Å

* Column Dimension (length x i.d.)

150mmx4.6mm
250mmx4.6mm
300mmx4.6mm

Catalog Number

CP-10-100/15
CP-10-100/25
CP-10-100/30

SMT CN - Columns 10 µm, 300Å

* Column Dimension (length x i.d.)

150mmx4.6mm
250mmx4.6mm
300mmx4.6mm

Catalog Number

CP-10-300/15
CP-10-300/25
CP-10-300/30

*Guard column: 20mmx4.0mm; add suffix G to Catalog Number

+Other dimensions available; Please contact SMT, Inc. for quotation



Separation of Explosives

Column: CP-5-100/25

Solutes:
1=nitrobenzene
2=m-Dinitrobenzene
3=1,3,5-Trinitrobenzene
4=4-Nitrotoluene
5=2,4,6-Trinitrotoluene

Eluent: ACN: Water (60:40)
Flow: 1.0 mL/min
Detector: UV, 254nm
Temp: 30°C

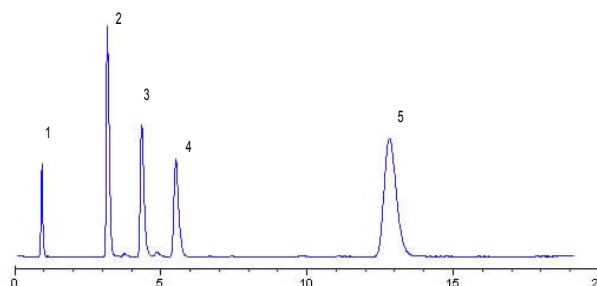

Separation of Estrogens

Column: CP-10-100/25

Solutes:
1=Estrone
2=Beta-estrone
3=Ethinylestradiol
4=Diethylstilbestrol

Eluent: Hexane: ethanol 92:8
Flow: 1.0 mL/min
Detector: UV; 254nm
Temp: 40°C

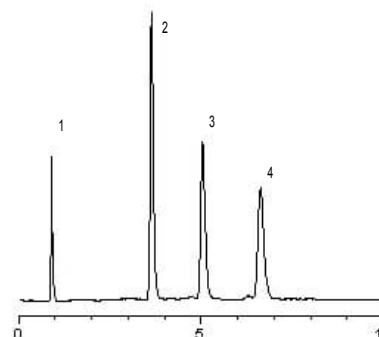

Ion-Exchange Chromatography

In this mode of chromatography, the separation depends upon the exchange of ions between the mobile phase and the ionic sites of the packing (cationic or anionic). Shown in Figure 1 is a schematic representation of the ion exchange process for cation exchange and anion exchange chromatography.

The stationary phase matrix has a functional group with a fixed ionic charge covalently attached to it. An exchangeable counterion from the mobile phase buffer preserves charge neutrality. The mobile phase usually contains a large number of counterions opposite in charge to the surface ionic group. The counterions are in equilibrium with the matrix charged group in form of an ion-pair. The presence of a sample ion of the same ionic charge as the counterion sets up another equilibrium. The sample ion can exchange with the counterion to form an ion-pair with the matrix. The retention of the sample ion is based on the affinity of the different ions for the site on the matrix and on a number of other solution parameters such as, pH, ionic strength, counterion type, etc. For example, sodium chloride is used in the mobile phase buffer, the counterion is Na^+ (in the case of cation exchange process) and Cl^- (in the case of anion exchange process).

Separation Methods Technologies, Incorporated has developed new series of ion-exchange packing materials with its novel SAM technology. These packings are offered for all stages of separation science from analytical scale levels to process scale purification levels. Analytical columns are usually available in 5 and 10 micron particle sizes. Bulk packings are offered in larger particle sizes like 20, 40, and 60 microns. These packing are not only suitable for low pressure column chromatography but also perfect for solid phase extractions. SMT ion exchange series include Strong Anion eXchange (SAX), Weak Anion eXchange (WAX), Strong Cation eXchange (SCX), Weak Cation eXchange (WCX), and DiEthyl Amino Ethyl (DEAE). An important characteristic of all the packings is unprecedented high exchange capacity. This characteristic can be associated with the extremely high ion-exchange ligand density produced by the SAM technology. High exchange capacity often results in superior selectivity and efficiency as well as high recovery of analytes.

Figure 1. Schematic representation of ion-exchange chromatography

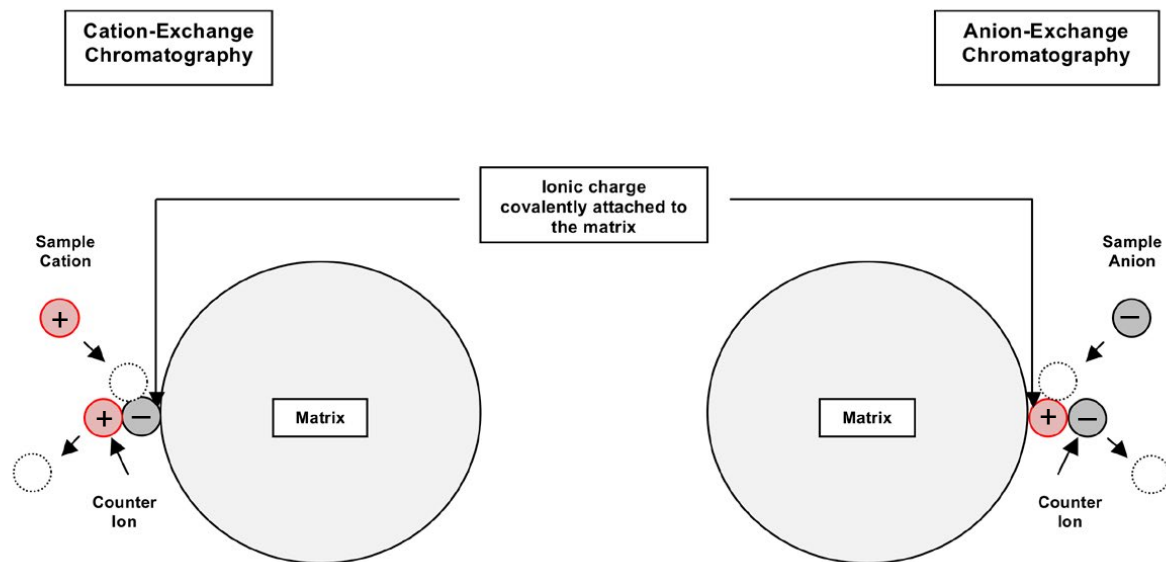

SMT SAX Columns & Applications

SMT SAX columns are silica-based Strong Anion eXchange packing developed for separation of anionic compounds. SMT SAX packings consist of chemically attached hydrophilic surface derivatized to form quaternary amine. The technique of SAM is used in the bonding process to significantly increase the functional ligand density. Unlike polymer-based SAX, the packing material is mechanically stable at high flow rates and high pressures up to 6,000 psi. SMT SAX packing does not swell with organic solvents, salts, or pH gradients

Special features:

- Superior selectivity and efficiency in separation of proteins and biomolecules.
- High stability under extreme operating conditions.
- High recovery of analytes.

SMT SAX columns are available in various particle and pore sizes: 5 and 10µm; 100 and 300Å are available stock sizes.

Typical Column Specification:	SAX-Columns	
5 µm Silica	100Å	300Å
Surface Area [m ² /g]	340	90
Capacity [meq/g]	0.92	0.39

Ordering Information

SMT SAX - Columns 5 µm, 100Å

* Column Dimension (length x i.d.)

50mmx4.6mm
75mmx4.6mm
100mmx4.6mm
150mmx4.6mm
250mmx4.6mm
300mmx4.6mm

Catalog Number

SAX-5-100/5
SAX-5-100/7.5
SAX-5-100/10
SAX-5-100/15
SAX-5-100/25
SAX-5-100/30

SMT SAX - Columns 5 µm, 300Å

* Column Dimension (length x i.d.)

50mmx4.6mm
75mmx4.6mm
100mmx4.6mm
150mmx4.6mm
250mmx4.6mm
300mmx4.6mm

Catalog Number

SAX-5-300/5
SAX-5-300/7.5
SAX-5-300/10
SAX-5-300/15
SAX-5-300/25
SAX-5-300/30

SMT SAX - Columns 10 µm, 100Å

* Column Dimension (length x i.d.)

50mmx4.6mm
75mmx4.6mm
100mmx4.6mm
150mmx4.6mm
250mmx4.6mm
300mmx4.6mm

Catalog Number

SAX-10-100/5
SAX-10-100/7.5
SAX-10-100/10
SAX-10-100/15
SAX-10-100/25
SAX-10-100/30

SMT SAX - Columns 10 µm, 300Å

* Column Dimension (length x i.d.)

50mmx4.6mm
75mmx4.6mm
100mmx4.6mm
150mmx4.6mm
250mmx4.6mm
300mmx4.6mm

Catalog Number

SAX-10-300/5
SAX-10-300/7.5
SAX-10-300/10
SAX-10-300/15
SAX-10-300/25
SAX-10-300/30

*Guard column: 20mmx4.0mm; add suffix G to Catalog Number
+Other dimensions available; Please contact SMT, Inc. for quotation



Separation of Protein molecules

Column: SAX-5-300/15
Solute: 1=cytochrome C [horse heart]
2=lysozyme [chicken egg white]
3=albumin [chicken egg]
Eluent: A=0.02M Tris [pH=7] B=0.02M Tris, 1.0M NaOAc [pH=7] gradient 0-100%B in 10 min
Flow: 1.0 mL/min
Detector: UV; 260nm
Temp: 30°C

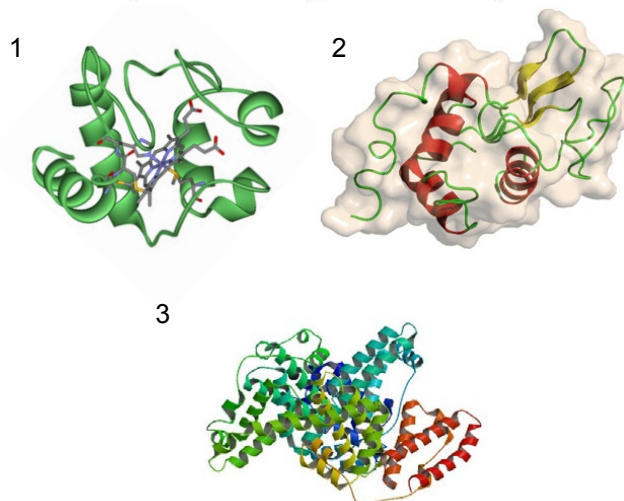
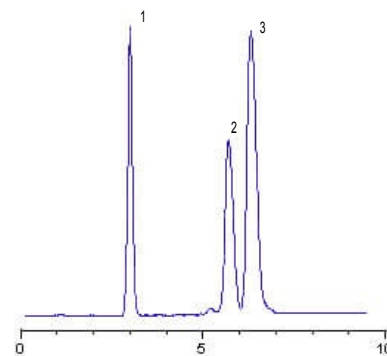

SMT WAX Columns & Applications

SMT WAX columns are silica-based Weak Anion eXchange packing materials developed for separation of anionic compounds.

SMT WAX consists of chemically attached hydrophilic surface derivatized to form polyethyleneimine functionality on silica substrate. The technique of SAM is used in the bonding process to significantly increase the functional ligand density. Unlike polymer-based WAX, the packing material is mechanically stable at high flow rates and high pressures up to 6,000 psi. SMT WAX packing does not swell with organic solvents, salts, or pH gradients

Special features:

- Superior selectivity and efficiency in separation of proteins and biomolecules.
- High stability under extreme operating conditions.
- High density polyethyleneimine functional groups that provide improved recovery compared to conventional WAX.

SMT WAX columns are available in various particle and pore sizes: 5 and 10µm; 100 and 300Å are available stock sizes.

Typical Column Specification:	WAX-Columns	
5 µm Silica	100Å	300Å
Surface Area [m ² /g]	340	90
Capacity [meq/g]	0.96	0.38



Separation of Biomolecules: Nucleotides

Column: WAX-5-100/15

Solutes:
1=CMP
2=AMP
3=UMP
4=CDP

Eluent: A=0.1M Sodium phosphate buffer [pH=3]; B=0.1M Sodium phosphate and 2.0M NaCl [pH=3] gradient 0-100% B in 20 min

Flow: 1.0 mL/min
Detector: UV; 254nm
Temp: 30°C

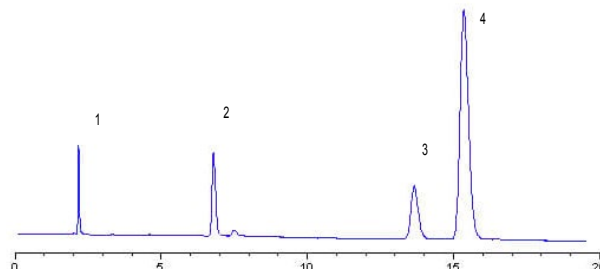

Ordering Information

SMT WAX - Columns 5 µm, 100Å

* Column Dimension (length x i.d.)

50mmx4.6mm
75mmx4.6mm
100mmx4.6mm
150mmx4.6mm
250mmx4.6mm
300mmx4.6mm

Catalog Number
WAX-5-100/5
WAX-5-100/7.5
WAX-5-100/10
WAX-5-100/15
WAX-5-100/25
WAX-5-100/30

SMT WAX - Columns 5 µm, 300Å

* Column Dimension (length x i.d.)

50mmx4.6mm
75mmx4.6mm
100mmx4.6mm
150mmx4.6mm
250mmx4.6mm
300mmx4.6mm

Catalog Number
WAX-5-300/5
WAX-5-300/7.5
WAX-5-300/10
WAX-5-300/15
WAX-5-300/25
WAX-5-300/30

SMT WAX - Columns 10 µm, 100Å

* Column Dimension (length x i.d.)

50mmx4.6mm
75mmx4.6mm
100mmx4.6mm
150mmx4.6mm
250mmx4.6mm
300mmx4.6mm

Catalog Number
WAX-10-100/5
WAX-10-100/7.5
WAX-10-100/10
WAX-10-100/15
WAX-10-100/25
WAX-10-100/30

SMT WAX - Columns 10 µm, 300Å

* Column Dimension (length x i.d.)

50mmx4.6mm
75mmx4.6mm
100mmx4.6mm
150mmx4.6mm
250mmx4.6mm
300mmx4.6mm

Catalog Number
WAX-10-300/5
WAX-10-300/7.5
WAX-10-300/10
WAX-10-300/15
WAX-10-300/25
WAX-10-300/30

*Guard column: 20mmx4.0mm; add suffix G to Catalog Number
*Other dimensions available; Please contact SMT, Inc. for quotation

SMT DEAE Columns & Applications

SMT DEAE [Di-Ethyl-Amino-Ethyl] column provides a unique chemically attached hydrophilic, weak anion exchange type, functional surface desirable for the separation of many bio-molecules such as proteins, nucleotides, oligonucleotides, polynucleotides, high molecular weight RNA's and plasmid DNA's. The technique of SAM is used in the bonding process to significantly increase the functional ligand density.

SMT DEAE is silica based and the packing material is mechanically stable at high flow rates and high pressures up to 6,000 psi. SMT DEAE packing does not swell with organic solvents, salts, or pH gradients.

Special features:

- Fast reequilibration and very negligible non-specific protein interaction.
- High density tertiary amine functional groups that provide better selectivity and recovery compared to conventional DEAE.
- Highly stable silica-based anion exchange type packing material; Minimal compressibility and will not swell in organic solvents or in the presence of ion pairing reagents.

SMT DEAE columns are available in various particle and pore sizes: 5 and 10µm; 100 and 300Å are available stock sizes.

Typical Column Specification:	DEAE-Columns	
5 µm Silica	100Å	300Å
Surface Area [m ² /g]	340	90
Capacity [meq/g]	0.95	0.37



Separation of Plasmid DNA molecules

Column: DEAE-5-100/25
 Solutes: Plasmid DNA [supercoil DNA]
 Eluent: A=0.025M Citrate buffer [pH=5]; B=A + 1.5M NaCl (50:50) gradient 0-100% B in 12 min
 Flow: 1.5 mL/min
 Detector: UV; 260nm
 Temp: 30°C

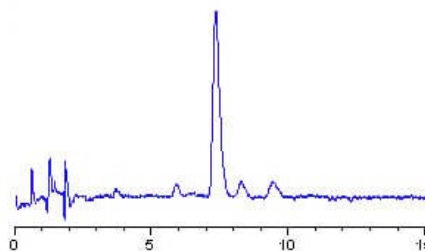

Ordering Information

SMT DEAE - Columns 5 µm, 100Å

* Column Dimension (length x i.d.)

50mmx4.6mm
 75mmx4.6mm
 100mmx4.6mm
 150mmx4.6mm
 250mmx4.6mm
 300mmx4.6mm

Catalog Number
 DEAE-5-100/5
 DEAE-5-100/7.5
 DEAE-5-100/10
 DEAE-5-100/15
 DEAE-5-100/25
 DEAE-5-100/30

SMT DEAE - Columns 5 µm, 300Å

* Column Dimension (length x i.d.)

50mmx4.6mm
 75mmx4.6mm
 100mmx4.6mm
 150mmx4.6mm
 250mmx4.6mm
 300mmx4.6mm

Catalog Number
 DEAE-5-300/5
 DEAE-5-300/7.5
 DEAE-5-300/10
 DEAE-5-300/15
 DEAE-5-300/25
 DEAE-5-300/30

SMT DEAE - Columns 10 µm, 100Å

* Column Dimension (length x i.d.)

50mmx4.6mm
 75mmx4.6mm
 100mmx4.6mm
 150mmx4.6mm
 250mmx4.6mm
 300mmx4.6mm

Catalog Number
 DEAE-10-100/5
 DEAE-10-100/7.5
 DEAE-10-100/10
 DEAE-10-100/15
 DEAE-10-100/25
 DEAE-10-100/30

SMT DEAE - Columns 10 µm, 300Å

* Column Dimension (length x i.d.)

50mmx4.6mm
 75mmx4.6mm
 100mmx4.6mm
 150mmx4.6mm
 250mmx4.6mm
 300mmx4.6mm

Catalog Number
 DEAE-10-300/5
 DEAE-10-300/7.5
 DEAE-10-300/10
 DEAE-10-300/15
 DEAE-10-300/25
 DEAE-10-300/30

*Guard column: 20mmx4.0mm; add suffix G to Catalog Number
 +Other dimensions available; Please contact SMT, Inc. for quotation

SMT SCX Columns & Applications

SMT SCX columns are silica-based Strong Cation eXchange packing materials developed for separation of cationic compounds.

SMT SCX consists of chemically attached hydrophilic surface derivatized to form sulfonic acid functionality on silica substrate. The technique of SAM is used in the bonding process to significantly increase the functional ligand density. Unlike polymer-based SCX, the packing material is mechanically stable at high flow rates and high pressures up to 6,000 psi. SMT SCX packing does not swell with organic solvents, salts, or pH gradients

Special features:

- Superior selectivity and efficiency in separation of proteins and biomolecules with medium to high [isoelectric point] or pH values.
- High stability under extreme operating conditions.
- High density sulfonic acid functional groups that provide improved recovery compared to conventional SCX.

SMT SCX columns are available in various particle and pore sizes: 5 and 10µm; 100 and 300Å are available stock sizes.

Typical Column Specification:	SCX-Columns	
5 µm Silica	100Å	300Å
Surface Area [m ² /g]	340	90
Capacity [meq/g]	0.94	0.36



Separation of Biomolecules: Proteins

Column: SCX-5-300/25
Solutes: 1=cytochrome C
 2=lysozyme
 3=lactoglobulin
 4=albumin
Eluent: A=Potassium phosphate [pH=6] B=A + 0.5M NaCl
 gradient 0-80%B in 20 min
Flow: 1.0 mL/min
Detector: UV; 210nm
Temp: 30°C

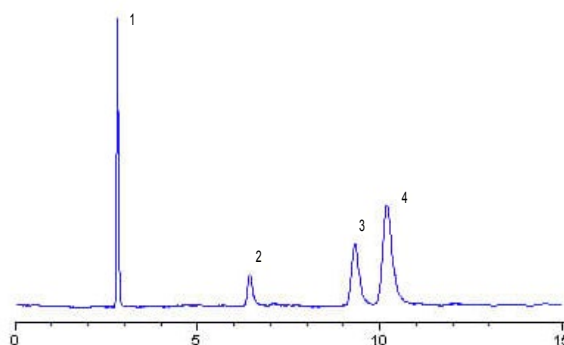

Ordering Information

SMT SCX - Columns 5 µm, 100Å

* Column Dimension (length x i.d.)

50mmx4.6mm
 75mmx4.6mm
 100mmx4.6mm
 150mmx4.6mm
 250mmx4.6mm
 300mmx4.6mm

Catalog Number

SCX-5-100/5
 SCX-5-100/7.5
 SCX-5-100/10
 SCX-5-100/15
 SCX-5-100/25
 SCX-5-100/30

SMT SCX - Columns 5 µm, 300Å

* Column Dimension (length x i.d.)

50mmx4.6mm
 75mmx4.6mm
 100mmx4.6mm
 150mmx4.6mm
 250mmx4.6mm
 300mmx4.6mm

Catalog Number

SCX-5-300/5
 SCX-5-300/7.5
 SCX-5-300/10
 SCX-5-300/15
 SCX-5-300/25
 SCX-5-300/30

SMT SCX - Columns 10 µm, 100Å

* Column Dimension (length x i.d.)

50mmx4.6mm
 75mmx4.6mm
 100mmx4.6mm
 150mmx4.6mm
 250mmx4.6mm
 300mmx4.6mm

Catalog Number

SCX-10-100/5
 SCX-10-100/7.5
 SCX-10-100/10
 SCX-10-100/15
 SCX-10-100/25
 SCX-10-100/30

SMT SCX - Columns 10 µm, 300Å

* Column Dimension (length x i.d.)

50mmx4.6mm
 75mmx4.6mm
 100mmx4.6mm
 150mmx4.6mm
 250mmx4.6mm
 300mmx4.6mm

Catalog Number

SCX-10-300/5
 SCX-10-300/7.5
 SCX-10-300/10
 SCX-10-300/15
 SCX-10-300/25
 SCX-10-300/30

*Guard column: 20mmx4.0mm; add suffix G to Catalog Number

+Other dimensions available; Please contact SMT, Inc. for quotation

SMT WCX Columns & Applications

SMT WCX columns are silica-based Weak Cation eXchange packing materials developed for separation of cationic compounds.

SMT WCX consists of chemically attached hydrophilic surface derivatized to form carboxylic acid functionality on silica substrate. The technique of SAM is used in the bonding process to significantly increase the functional ligand density. Unlike polymer-based WCX, the packing material is mechanically stable at high flow rates and high pressures up to 6,000 psi. SMT WCX packing does not swell with organic solvents, salts, or pH gradients

Special features:

- Superior selectivity and efficiency in separation of proteins and biomolecules high stability under extreme operating conditions.
- High density carboxylic acid functional groups provide much better analyte recovery compared to conventional WCX.

SMT WCX columns are available in various particle and pore sizes: 5 and 10µm; 100 and 300Å are available stock sizes.



Separation of Biomolecules

Column: WCX-5-300/25
Solutes: 1=trypsinogen
 2=ribonuclease A
 3=cytochrome C
 4=chmotrypsinogen
Eluent: A=0.05M Sodium phosphate [pH=6]; B= 0.5M Sodium phosphate [pH=6]
 gradient 0-20%B in 20 min; Hold 5 min, then 20-60% B in 50 min
Flow: 1.0 mL/min
Detector: UV; 280nm
Temp: 30°C

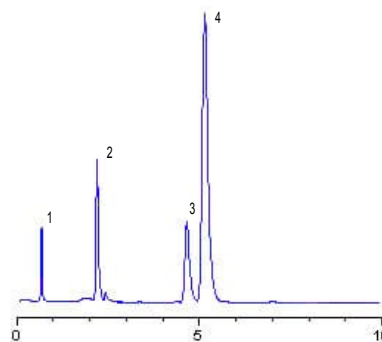

Typical Column Specification:	WCX-Columns	
5 µm Silica	100Å	300Å
Surface Area [m ² /g]	340	90
Capacity [meq/g]	0.91	0.35

Ordering Information

SMT WCX - Columns 5 µm, 100Å

* Column Dimension (length x i.d.)	Catalog Number
50mmx4.6mm	WCX-5-100/5
75mmx4.6mm	WCX-5-100/7.5
100mmx4.6mm	WCX-5-100/10
150mmx4.6mm	WCX-5-100/15
250mmx4.6mm	WCX-5-100/25
300mmx4.6mm	WCX-5-100/30

SMT WCX - Columns 5 µm, 300Å

* Column Dimension (length x i.d.)	Catalog Number
50mmx4.6mm	WCX-5-300/5
75mmx4.6mm	WCX-5-300/7.5
100mmx4.6mm	WCX-5-300/10
150mmx4.6mm	WCX-5-300/15
250mmx4.6mm	WCX-5-300/25
300mmx4.6mm	WCX-5-300/30

*Guard column: 20mmx4.0mm; add suffix G to Catalog Number
 +Other dimensions available; Please contact SMT, Inc. for quotation

SMT WCX - Columns 10 µm, 100Å

* Column Dimension (length x i.d.)	Catalog Number
50mmx4.6mm	WCX-10-100/5
75mmx4.6mm	WCX-10-100/7.5
100mmx4.6mm	WCX-10-100/10
150mmx4.6mm	WCX-10-100/15
250mmx4.6mm	WCX-10-100/25
300mmx4.6mm	WCX-10-100/30

SMT WCX - Columns 10 µm, 300Å

* Column Dimension (length x i.d.)	Catalog Number
50mmx4.6mm	WCX-10-300/5
75mmx4.6mm	WCX-10-300/7.5
100mmx4.6mm	WCX-10-300/10
150mmx4.6mm	WCX-10-300/15
250mmx4.6mm	WCX-10-300/25
300mmx4.6mm	WCX-10-300/30

Introduction to SMT Specialty Columns

SMT has special interest in surface modification biotechnology and materials engineering. When separation is difficult with conventional bonded phases, SMT assists in method development and special column design for new applications. SMT specialty columns include special columns designed for reversed phase, normal phase, and ion exchange chromatography. These columns are specially designed for companies that are interested in having competitive advantage in separation and surface modification. Bulk packing materials are also developed for similar applications as needed from analytical to process scale.



The following specialty columns are currently available:

Column	Function
PAH	Analysis of polyaromatic hydrocarbons
TNT	Separation of Explosives
OD-AQ and O-AQ	Polar/nonpolar/basic compounds
DIOL1 and DIOL2	Normal & reversed phase separation of polar compounds
MEB1	Analysis of hydrophobic proteins
MEB2	Analysis of hydrophobic proteins
MEB4	Analysis of biomolecules
C3	Analysis of Nonpolar/polar compounds
C5	Analysis of Nonpolar/polar compounds
C6	Analysis of Nonpolar/Polar compounds
C12	Analysis of Nonpolar/Polar compounds
C30	Nonpolar compounds
Urea	Polar compounds
QuickSep	Quick screening/analysis
ChiralSep1	Separation of Enantiomers
ChiralSep2	Separation of Enantiomers
CIB-Ovomucoid	Separation of Enantiomers
CIB-ProteinA	Analysis of antibodies
CIB-IgG	Analysis of proteinA
MetalSep	Metal removal
C ₈ F ₅	Separation of Taxols
Pheny1	Separation of polyaromatic compounds
Pheny2	Separation of polyaromatic compounds
PhenyH	Separation of polyaromatic compounds
USP	Regulated Analytical Methods
Micro/Narrow Bore	LC/MS, LC/GC, Drug Screening
UPLC1.5	UHPLC analysis
UPLC1.8	UHPLC analysis
SAX	Separation of anionic compounds
WAX	Separation of anionic compounds
DEAE	Weak anion for separation of biomolecules
SCX	Separation of cationic compounds
WCX	Separation of cationic compounds
GPC	Separation of oligomers and polymers
Guard	Column Guard

SMT PAH Columns and Applications

Polyaromatic hydrocarbons (PAH's) are large organic compounds produced during combustion. Many of these compounds are carcinogenic and are often found in water, air and other natural habitats. Monitoring of these compounds is very crucial for a healthy environment. The major challenge in HPLC analysis of PAH's is in the resolution of their structurally similar isomers. Figure 1 shows the resolution of 16 PAH's designated as Priority pollutants by the US EPA. SMT PAH1 columns consist of octadecyl functional ligands and are made with silica with proprietary pore size..



Separation of PAH's

Column: PAH1/25

Solutes:
 1=naphthalene
 2=acenaphthylene
 3=acenaphthene
 4=fluorene
 5=phenanthrene
 6=anthracene
 7=fluoranthene
 8=pyrene
 9=benzo[a]anthracene
 10=chrysene
 11=benzo[b]fluoranthene
 12=benzo[k]fluoranthene
 13=benzo[a]Pyrene
 14=dibenzo[a,h]anthracene
 15=benzo[ghi]perylene
 16=indeno[1,2,3,cd]pyrene

Eluent: ACN: Water 40:60 (v:v); hold 5 min, gradient to 100% ACN in 25 min
 Flow: 1.5 mL/min
 Detector: UV; 254nm
 Temp: 30°C

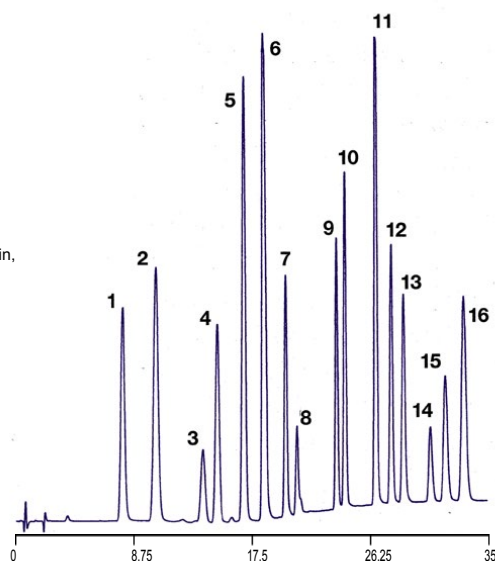

Ordering Information

SMT PAH1 - Columns 5 µm

*Column Dimension (length x i.d.)
 150mmx4.6mm

*Column Dimension (length x i.d.)
 150mmx3.9mm

Catalog Number
 PAH1-5/15

Catalog Number
 PAH1-5/154

*Column Dimension (length x i.d.)
 250mmx4.6mm

*Column Dimension (length x i.d.)
 250mmx3.9mm

Catalog Number
 PAH1-5/25

Catalog Number
 PAH1-5/254

*Guard column: 20mmx4.0mm; add suffix G to Catalog Number
 +Other dimensions available; Please contact SMT, Inc. for quotation

SMT TNT-Columns & Applications

SMT TNT columns are specially designed C18 column for use in the reversed-phase separation of nitroaromatic and nitroamine derivatives. The isomeric nature of these explosive compounds is the reason for the difficulty in their separation.

The standard test method for the analysis of seven nitroaromatic and nitroamine explosives in soil by HPLC specifies the use of two reversed-phase columns [C18 and CN] in series.

A new HPLC method developed using SMT TNT1 is very simple and results in separation of six nitroaromatic explosives in fifteen minutes or less with a single column using a simple isocratic elution.



Special features:

- Highly reproducible mixed bonded phase; consistent separation of analytes.
 - Increased longevity provided through "total coverage".
- The column also offers enhanced separation for pesticides, herbicides, pharmaceutical metabolites, polar natural products and other polar biomolecules.

Separation of Nitro-aromatic Explosives

Column: TNT1-5-100/15
Solutes: 1=1,3,5-trinitrobenzene
2=1,3-dinitrobenzene
3=2,4,6-trinitrotoluene
4=nitrobenzene
5=2,4-dinitrotoluene
6=2-amino-DNT
Eluent: ACN: Water 55:45 (v:v) isocratic
Flow: 1.0 mL/min
Detector: UV; 254nm
Temp: 30°C

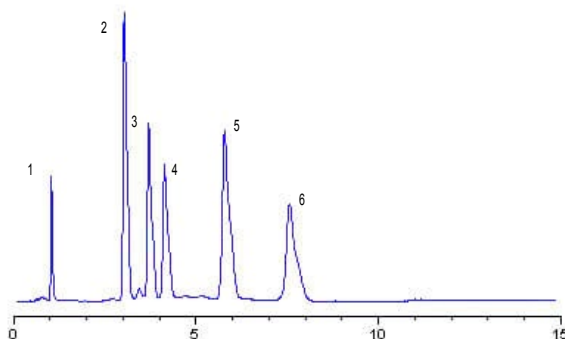
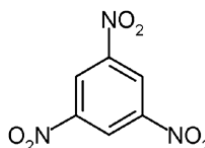

Ordering Information

SMT TNT1 - Columns 5 µm, 100Å

*Column Dimension (length x i.d.)
150mmx4.6mm

Catalog Number
TNT1-5-100/15

*Column Dimension (length x i.d.)
250mmx4.6mm

Catalog Number
TNT1-5-100/25

*Column Dimension (length x i.d.)
150mmx3.9mm

Catalog Number
TNT1-5-100/154

*Column Dimension (length x i.d.)
250mmx3.9mm

Catalog Number
TNT1-5-100/254

*Guard column: 20mmx4.0mm; add suffix G to Catalog Number
+Other dimensions available; Please contact SMT, Inc. for quotation

SMT OD-AQ Columns & Applications

SMT OD-AQ (or OD-IQ) is unique reversed phase packing material designed to have both hydrophobic and truly hydrophilic spacer ligands. The mixed-phase consists of a meticulously controlled mixture of hydrophobic, C18 molecules, and proprietary hydrophilic molecules, chemically attached on the silica substrate, using "total coverage" technology. The result is a stationary phase that has all of the following characteristics:

- Stronger retention of polar molecules in aqueous eluent.
- Reduced back-pressure; the hydrophilic hybrid enhances the solvation of the bonded phase in an aqueous environment.
- Different selectivity compared to conventional C18.
- Eliminates the need for ion pairing reagents

The column offers enhanced separation for proteins, peptides, nucleotides and other biomolecules. The column is

also recommended for the analyses of highly polar organic compounds.



Separation of Amino Acids

Column: ODAQ-5-100/15

Solutes:
1=tyrosine
2=phenylalanine
3=tryptophan

Eluent: A:0.25mM potassium phosphate, pH=2.5 B:ACN
5%-20% B 0-5min 20%-5% B 5-8min Hold 5% B 9-12min

Flow: 1.0 mL/min

Detector: UV; 254nm

Temp: 30°C

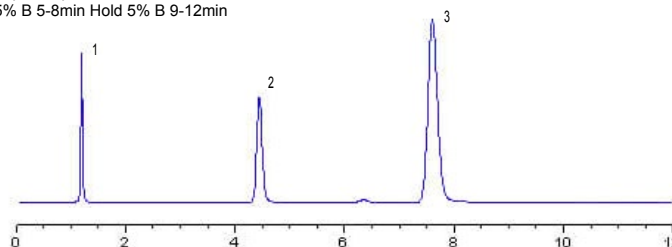

Organic Acids

Column: ODAQ-5-100/15

Solutes:
1=glycolic acid
2=malonic acid
3=acetic acid
4=maleic acid

Eluent: Potassium phosphate, pH 2.5; ACN 95:5 (v:v)

Flow: 1.0 mL/min

Detector: UV; 210nm

Temp: 30°C

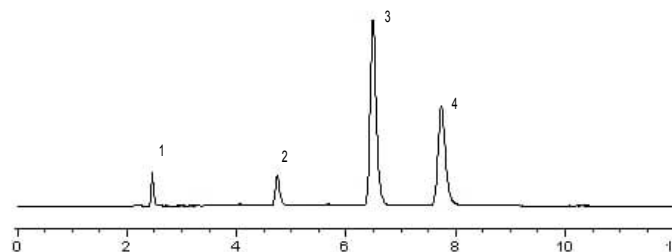

Ordering Information

SMT ODAQ - Columns 5 µm, 100Å

*Column Dimension (length x i.d.)

150mmx4.6mm

250mmx4.6mm

Catalog Number

ODAQ-5-100/15

ODAQ-5-100/25

SMT ODAQ - Columns 5 µm, 300Å

*Column Dimension (length x i.d.)

150mmx4.6mm

250mmx4.6mm

Catalog Number

ODAQ-5-300/15

ODAQ-5-300/25

*Guard column: 20mmx4.0mm; add suffix G to Catalog Number

+Other dimensions available; Please contact SMT, Inc. for quotation

SMT SAM-C3 Columns & Applications

SMT SAM-C3 columns consist of Propyl as the functional ligand. The columns offer selectivities that are different from C8 and C18 reversed-phase columns when applied to separation of polyaromatic hydrocarbons. SMT-C3 columns are specially designed as complementary alternatives for the separation of polar, neutral and moderately nonpolar pharmaceuticals; natural products, food additives, organic chemicals and biological compounds or analytes that are generally retained too long on C8 or C18 columns. These columns can also be useful in separation of hydrophobic biomolecules, such as proteins.



Polar and Non-polar Compounds

Column: Pr-5-100/15
 Solutes: 1=Uracil
 2=Benzene
 3=Hexanophenone
 4=Anthracene
 Eluent: ACN: Water 70:30 (v:v)
 Flow: 1.0 mL/min
 Detector: UV; 254nm
 Temp: 30°C

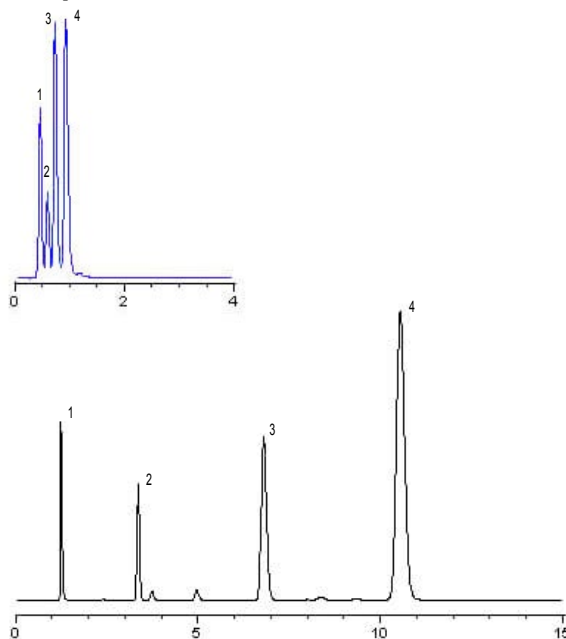

SAM Pr-Columns are available in various particle and pore sizes: 5 μm and 100 \AA are stock sizes.

Typical Column Specification:	SAM Prop-Columns	
5 μm Silica	100 \AA	300 \AA
Surface Area [m^2/g]	340	120
% Carbon	6.5	3.6
Coverage [moles/m^2]	7.5	7.4

Ordering Information

SMT Pr - Columns 5 μm , 100 \AA

*Column Dimension (length x i.d.)
 150mmx4.6mm
 250mmx4.6mm

*Column Dimension (length x i.d.)
 150mmx3.9mm
 250mmx3.9mm

Catalog Number
 Pr-5-100/15
 Pr-5-100/25

Catalog Number
 Pr-5-100/154
 Pr-5-100/254

SMT Pr - Columns 5 μm , 300 \AA

*Column Dimension (length x i.d.)
 150mmx4.6mm
 250mmx4.6mm

*Column Dimension (length x i.d.)
 150mmx3.9mm
 250mmx3.9mm

Catalog Number
 Pr-5-300/15
 Pr-5-300/25

Catalog Number
 Pr-5-300/154
 Pr-5-300/254

*Guard column: 20mmx4.0mm; add suffix G to Catalog Number
 *Other dimensions available; Please contact SMT, Inc. for quotation

SMT SAM-C5 [Pe] Columns & Applications

SMT SAM-C5 columns consist of Pentyl as the functional ligand. The columns offer selectivities that are different from C8 and C18 reversed-phase columns when applied to separation of polyaromatic hydrocarbons. SMT-C5 columns are specially designed as complementary alternatives for the separation of polar, neutral and moderately nonpolar pharmaceuticals; natural products, food additives, organic chemicals and biological compounds or analytes that are generally retained too long on C8 or C18 columns.



Polar and Non-polar Compounds

Column: Pe-5-100/15
 Solutes: 1=Uracil
 2=Benzene
 3=Hexanophenone
 4=Anthracene
 Eluent: ACN: Water 70:30 (v:v)
 Flow: 1.0 mL/min
 Detector: UV; 254nm
 Temp: 30°C

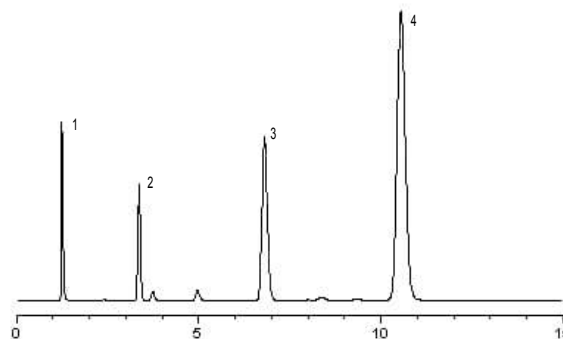
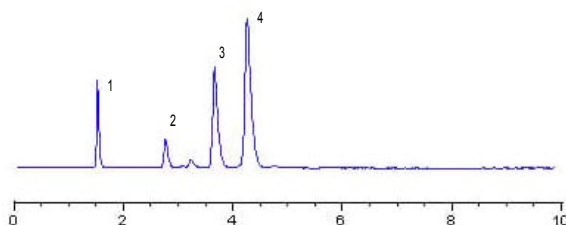

SAM Pe-Columns are available in various particle and pore sizes: 5 μm and 100 \AA are stock sizes.

Typical Column Specification:	SAM Pe-Columns	
5 μm Silica	100 \AA	300 \AA
Surface Area [m^2/g]	340	120
% Carbon	6.5	3.6
Coverage [moles/m^2]	7.5	7.4

Ordering Information

SMT Pe - Columns 5 μm , 100 \AA

*Column Dimension (length x i.d.)
 150mmx4.6mm
 250mmx4.6mm
 *Column Dimension (length x i.d.)
 150mmx3.9mm
 250mmx3.9mm

Catalog Number
 Pe-5-100/15
 Pe-5-100/25
 Catalog Number
 Pe-5-100/154
 Pe-5-100/254

SMT Pe - Columns 5 μm , 300 \AA

*Column Dimension (length x i.d.)
 150mmx4.6mm
 250mmx4.6mm
 *Column Dimension (length x i.d.)
 150mmx3.9mm
 250mmx3.9mm

Catalog Number
 Pe-5-300/15
 Pe-5-300/25
 Catalog Number
 Pe-5-300/154
 Pe-5-300/254

*Guard column: 20mmx4.0mm; add suffix G to Catalog Number
 +Other dimensions available; Please contact SMT, Inc. for quotation

SMT SAM-C6 [H] Columns & Applications

SMT SAM-C6 columns consist of Hexyl as the functional ligand. The columns offer selectivities that are different from C8 and C18 reversed-phase columns when applied to separation of polyaromatic hydrocarbons. SMT-C6 columns are specially designed as complementary alternatives for the separation of polar, neutral and moderately nonpolar pharmaceuticals; natural products, food additives, organic chemicals and biological compounds that are generally retained too long on C8 or C18 columns.



Polar and Nonpolar Compounds

Column: H-5-100/15
 Solutes: 1=Uracil
 2=Benzene
 3=Hexanophenone
 4=Anthracene
 Eluent: ACN: Water 70:30 (v:v)
 Flow: 1.0 mL/min
 Detector: UV; 254nm
 Temp: 30°C

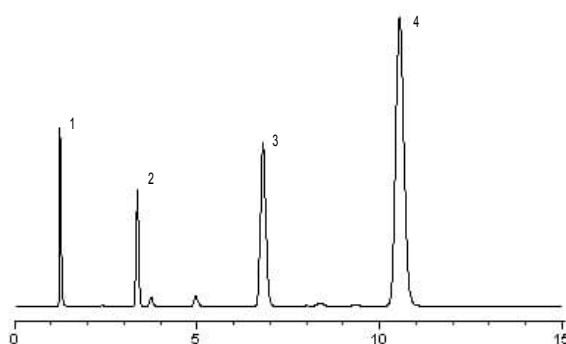
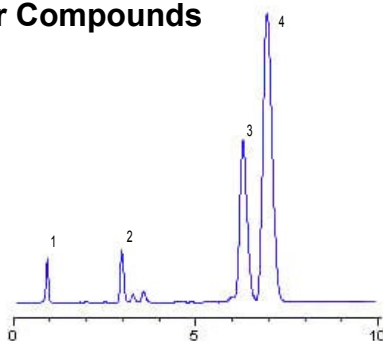

SAM H-Columns are available in various particle and pore sizes: 5 μm and 100 \AA are stock sizes.

Typical Column Specification:	SAM H-Columns	
5 μm Silica	100 \AA	300 \AA
Surface Area [m^2/g]	340	120
% Carbon	6.5	3.6
Coverage [moles/m^2]	7.5	7.4

Ordering Information

SMT H - Columns 5 μm , 100 \AA

*Column Dimension (length x i.d.)
 150mmx4.6mm
 250mmx4.6mm

*Column Dimension (length x i.d.)
 150mmx3.9mm
 250mmx3.9mm

Catalog Number
 H-5-100/15
 H-5-100/25

Catalog Number
 H-5-100/154
 H-5-100/254

SMT H - Columns 5 μm , 300 \AA

*Column Dimension (length x i.d.)
 150mmx4.6mm
 250mmx4.6mm

*Column Dimension (length x i.d.)
 150mmx3.9mm
 250mmx3.9mm

Catalog Number
 H-5-300/15
 H-5-300/25

Catalog Number
 H-5-300/154
 H-5-300/254

*Guard column: 20mmx4.0mm; add suffix G to Catalog Number
 +Other dimensions available; Please contact SMT, Inc. for quotation

SMT C12 [DD] Columns & Applications

SMT SAM-C12 columns consist of Dodecyl as the functional ligand. The columns offer selectivities that are intermediary and slightly different from C8 and C18 reversed-phase columns when applied to separation of polyaromatic hydrocarbons and other molecules. SMT-C12 columns are specially designed as complementary alternatives for the separation of polar, neutral and moderately nonpolar pharmaceuticals; natural products, food additives, organic chemicals and biologicals.



Polar and Non-polar Compounds

Column: A=DD-5-100/15 B=OD-5-100/15

Solutes:
1=Uracil
2=Benzene
3=Hexanophenone
4=Anthracene

Eluent: ACN: Water 70:30 (v:v)

Flow: 1.0 mL/min

Detector: UV; 254nm

Temp: 30°C

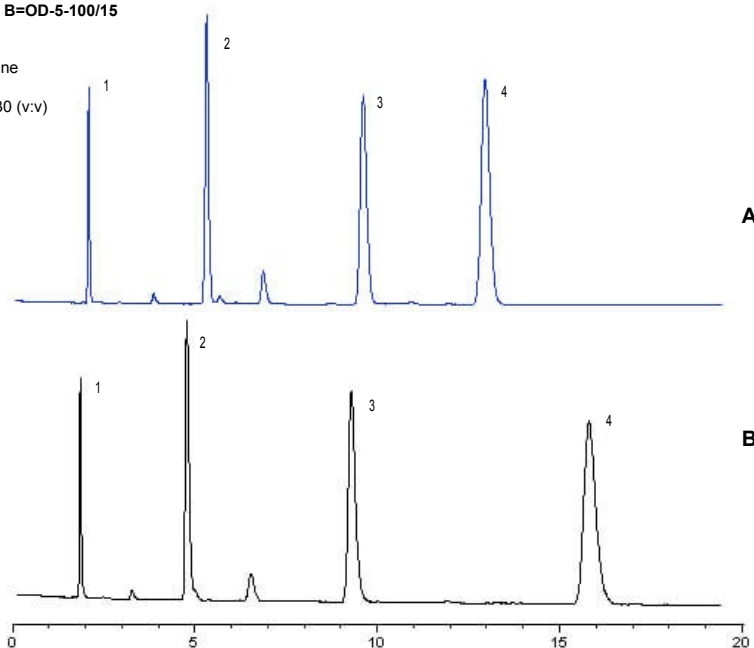

SAM DD-Columns are available in various particle and pore sizes: 5 μm and 100 \AA are stock sizes.

Typical Column Specification:	SAM DD-Columns	
5 μm Silica	100 \AA	300 \AA
Surface Area [m^2/g]	340	120
% Carbon	11	5
Coverage [moles/m^2]	7.5	7.4

Ordering Information

SMT DD - Columns 5 μm , 100 \AA

*Column Dimension (length x i.d.)

150mmx4.6mm

250mmx4.6mm

Column Dimension (length x i.d.)

150mmx3.9mm

250mmx3.9mm

Catalog Number

DD-5-100/15

DD-5-100/25

Catalog Number

DD-5-100/154

DD-5-100/254

SMT DD - Columns 5 μm , 300 \AA

*Column Dimension (length x i.d.)

150mmx4.6mm

250mmx4.6mm

*Column Dimension (length x i.d.)

150mmx3.9mm

250mmx3.9mm

Catalog Number

DD-5-300/15

DD-5-300/25

Catalog Number

DD-5-300/154

DD-5-300/254

*Guard column: 20mmx4.0mm; add suffix G to Catalog Number

+Other dimensions available; Please contact SMT, Inc. for quotation

SMT C30 [TA] Columns & Applications

SMT-C30 columns consist of Triacetyl as the functional ligand. The columns offer selectivities that are much different from C18 reversed-phase columns when applied to separation of carotenoid and related compounds. Carotenoids consist of very diverse groups of molecules that include non-polar hydrocarbons and polar xanthophylls.

These compounds have geometric and positional isomers with very subtle molecular differences that can pose challenges in separation. Previous efforts to separate these compounds with available C18 and other reversed phases have been unsatisfactory. SMT-C30 ligand provides sufficient interactive sites for complete partitioning of these positional isomers.



Separation of Carotenoids

Column: TA-5-100/15
Solutes: 1=15-cis-beta-carotene
 2=13-cis-beta-carotene
 3=trans-alpha-carotene
 4=trans-beta-carotene
Eluent: EtOH:MeOH:THF 65:20:15 (v:v:v)
Flow: 1.0 mL/min
Detector: UV; 450nm
Temp: 30°C

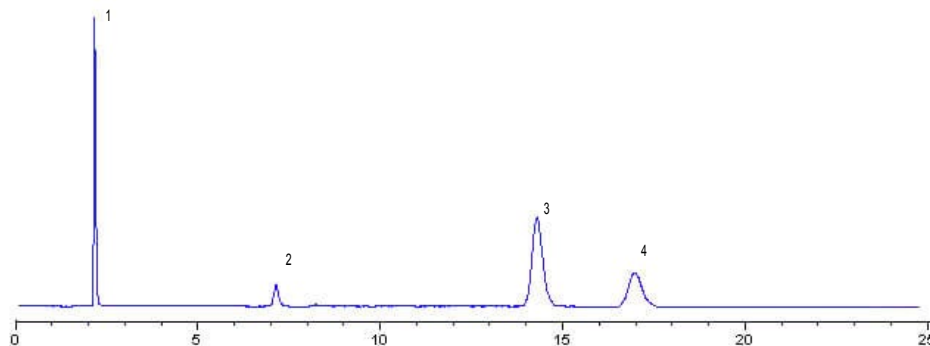

SAM TA-Columns are available in various particle and pore sizes: 5 μm and 100 \AA are stock sizes.

Typical Column Specification:	SAM TA-Columns
5 μm Silica	100 \AA
Surface Area [m^2/g]	340
% Carbon	28
Coverage [moles/m^2]	7.6

Ordering Information

SMT TA - Columns 5 μm , 100 \AA

*Column Dimension (length x i.d.)
150mmx4.6mm

Catalog Number
TA-5-100/15

*Column Dimension (length x i.d.)
250mmx4.6mm

Catalog Number
TA-5-100/25

*Column Dimension (length x i.d.)
150mmx3.9mm

Catalog Number
TA-5-100/154

*Column Dimension (length x i.d.)
250mmx3.9mm

Catalog Number
TA-5-100/254

*Guard column: 20mmx4.0mm; add suffix G to Catalog Number
 +Other dimensions available; Please contact SMT, Inc. for quotation

SMT Urea [Ur] Columns & Applications

SMT Urea columns consist of proprietary hydrophilic molecule as the functional ligand. The columns offer water-soluble functionality and selectivities that are different from other reversed-phase or normal phase columns when applied to separation of polar and basic compounds. SMT-Urea columns are specially designed for the separation of extremely basic analytes that are not retained in traditional reversed-phase columns. Unfortunately, these compounds are often the precursors in the development of many useful drug molecules. The ability to isolate and eventually remove traces of these compounds from the drug molecules is crucial to the overall drug discovery process.



Polar and Non-polar Compounds

Column: Ur-5-100/15 vs OD-5-100/15
Solute: 1=Uracil
 2=Anthracene
Eluent: ACN: Water 70:30 (v:v)
Flow: 1.0 mL/min
Detector: UV; 254nm
Temp: 30°C

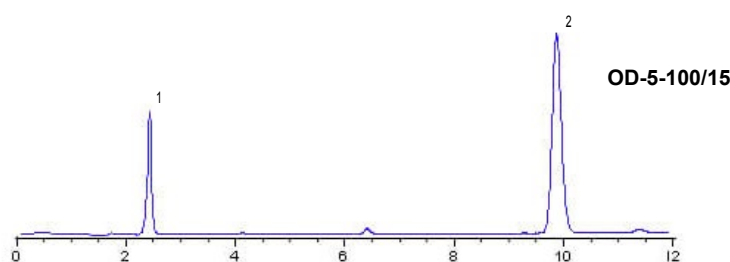
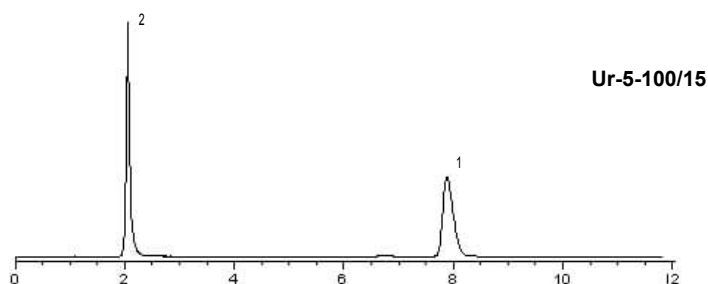

Ordering Information

SMT Ur - Columns 5 μ m, 100Å

*Column Dimension (length x i.d.)
150mmx4.6mm

*Column Dimension (length x i.d.)
150mmx3.9mm

Catalog Number

Ur-5-100/15

Catalog Number

Ur-5-100/154

*Column Dimension (length x i.d.)
250mmx4.6mm

*Column Dimension (length x i.d.)
250mmx3.9mm

Catalog Number

Ur-5-100/25

Catalog Number

Ur-5-100/254

*Guard column: 20mmx4.0mm; add suffix G to Catalog Number
*Other dimensions available; Please contact SMT, Inc. for quotation

SMT C₆F₅ Columns & Applications

SMT-C₆F₅ columns consist of Pentafluorophenyl as the functional ligand. The columns offer selectivities that are different from other reversed-phase columns when applied to separation of halogenated compounds, ketones, esters, and taxols. Taxol® (Paclitaxel) and some taxane analogs have been approved by the US Food and Drug Administration for treatment of ovarian cancer. SMT C₆F₅ columns are specially designed for the separation of Taxols. The crude and complex nature of the matrix tend to shorten the column lifetime when traditional reversed-phase columns are used in this application. SMT C₆F₅ columns are much more suitable alternatives for the separation of these compounds.



Analysis of Taxols®

Column: C6F5-5-100/25
Solutes: 1=10-Deacetyl Taxol
 2=Cephaloannine
 3=10-Deacetyl-7-Epi Taxol
 4=Taxol (Paclitaxel)
Eluent: ACN: Tetrahydrofuran:Water 20:35:45 (v:v:v) isocratic
Flow: 1.5 mL/min
Detector: UV; 230nm
Temp: 30°C

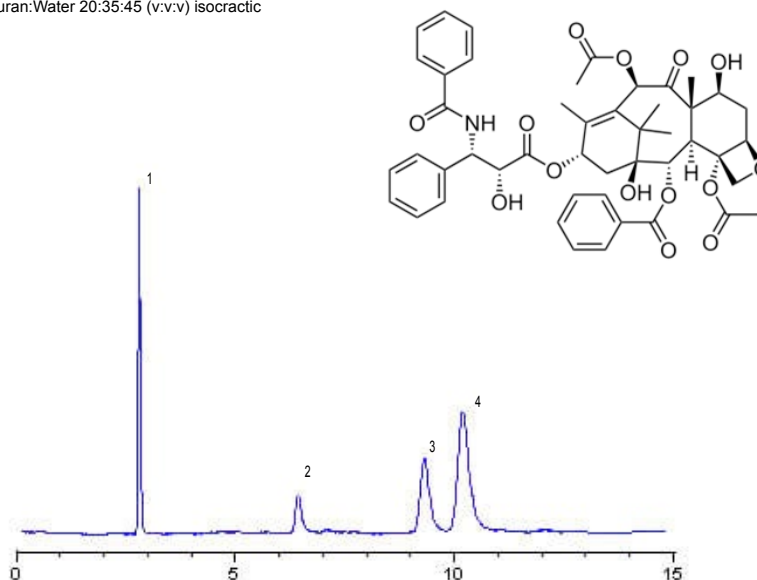

Ordering Information

SMT C6F5 - Columns 5 µm, 100Å

*Column Dimension (length x i.d.)
 150mmx4.6mm
 250mmx4.6mm

*Column Dimension (length x i.d.)
 150mmx3.9mm
 250mmx3.9mm

Catalog Number
 C6F5-5-100/15
 C6F5-5-100/25

Catalog Number
 C6F5-5-100/154
 C6F5-5-100/254

SMT C6F5 - Columns 10 µm, 100Å

*Column Dimension (length x i.d.)
 150mmx4.6mm
 250mmx4.6mm

*Column Dimension (length x i.d.)
 150mmx3.9mm
 250mmx3.9mm

Catalog Number
 C6F5-10-100/15
 C6F5-10-100/25

Catalog Number
 C6F5-10-100/154
 C6F5-10-100/254

*Guard column: 20mmx4.0mm; add suffix G to Catalog Number
 +Other dimensions available; Please contact SMT, Inc. for quotation

SMT MetalSep Columns & Applications

SMT MetalSep is offered as bulk packing materials for low pressure liquid chromatography, solid phase extraction, preparatory and process scale applications. The packings consist of proprietary strong cation exchange functional ligands that are chemically attached on silica substrate using SAM technique. The packing materials offer strong selectivities toward heavy metal ions such as Copper, gold, nickel, silver, iron, etc. Applications include:

- Precious metal recovery
- Minimized capital expenditure through optimized process design
- Reduced water consumption and abstraction via treated water recycling
- Improved productivity and product quality, through secured and clean process water
- Improved quality and reduced volume of generated sludge
- General purification of drinking or waste water

Typical Column Specification:	MetalSep1
35-50 μm silica	150 or 60Å
Surface Area [m^2/g]	360 or 560
Capacity [meq/g]	1.99 or 2.29

MetalSep1 packing materials are available for solid phase extraction and process scale applications in various particle sizes and pore sizes: 20, 35, 60 μm and 60, 150 and 300Å are stock sizes.

The packings are available in bulk quantities of 50gm, 100 gm, 250 gm, 500 gm, 5 Kg, 10 kg, 100 kg For larger quantities call for a price quote.

Precious Metal Recovery: Cu, Au, Ni, Ag, Fe
Product: MetalSep1-35-150 or MetalSep1-35-60
Solutes: 1=waste water from electroplating bath

Method:

1. Run industrial waste water through glass column packed with MetalSep1 column packing material (see diagram in Figure 1) that is equilibrated with aqueous solution [e.g. pH=7]
2. Collect the effluent and run into environmentally acceptable discharge.
3. Regenerate the packing by successive washing of the bed with aqueous solution of pH=6, pH=5, pH=4, pH=3, pH=2 and pH=1.
4. Continual purification is possible with repetitive application of steps 1 to 4 on isolated waste water sample.

Figure 1

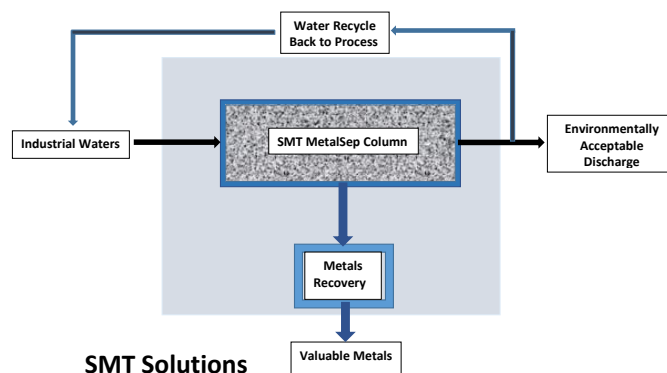

Ordering Information

SMT MetalSep - Columns/Packings 35-60 μm , 60Å	
*Product size (mass)	Catalog Number
50 g	MetalSep1-35-60/50G
100 g	MetalSep1-35-60/100G
250 g	MetalSep1-35-60/250G
500 g	MetalSep1-35-60/500G
1 kg	MetalSep1-35-60/1KG

SMT MetalSep - Columns/Packings 35-60 μm , 150Å	
*Product size (mass)	Catalog Number
50 g	MetalSep1-35-150/50G
100 g	MetalSep1-35-150/100G
250 g	MetalSep1-35-150/250G
500 g	MetalSep1-35-150/500G
1 kg	MetalSep1-35-150/1KG

SMT Affinity Chromatography Columns Chemically Immobilized Biomolecules (CIB)

Affinity Chromatography (AC) is based on the specific adsorption of a molecule to a ligand or macromolecule. Most biomolecules can be purified on the basis of specific interaction between their chemical or biological structure and a suitable affinity ligand. Typical molecular pairs are enzymes and coenzymes or antigens and antibodies. AC packing materials have spacer ligands that are first attached to the substrate before a reversible adsorption of a specific biomolecule. The adsorbed molecule is then eluted through a competitive displacement or by a change in the conformation of the molecule through a change in pH or ionic strength. In contrast to other chromatographic methods, AC is highly selective and is mostly suitable for specific separation problems.

Special features:

- Simplicity of the elution technique.
- High purification yields.

SMT manufactures the first series of commercially available silica-based Chemically Immobilized Biomolecules

(CIB) columns for high performance purification of other biomolecules such as proteins, enzymes and antibodies. In production of CIB columns, SMT utilizes its proprietary technique of self-assembled monolayer (SAM) of bonding to first immobilize unique mixed phases of appropriate silane ligands that are capable of effectively anchoring functional biomolecules on the silica substrates. This total coverage™ technology ensures complete elimination of non-specific binding sites on the silica surface. The rigidity of silica particles enables the columns to be used under high performance chromatographic application and the stability of the bonded phase results in efficient purification of molecules or biomolecules of interest. SMT CIB columns include columns that can be used for other applications such as resolution of chiral compounds. Interesting characteristics such as dynamic binding capacity and specific recovery of products of interest on the columns are generally evaluated. Other potential application of this new bonding technique includes immobilization of various biomolecules including proteins, antibodies as well as enzymes that could enhance various chemical reactions of interest.

SMT CIB-ProteinA Columns & Applications

SMT CIB-ProteinA are silica-based packing materials designed for both high performance and low-pressure purification of antibodies, IgG. In production of the ProteinA affinity-type columns, SMT utilizes its proprietary technique of self-assembled monolayer (SAM) of bonding to first immobilize unique mixed phases of appropriate silane ligands that are capable of effectively anchoring protein A on silica substrates. This total coverage™ technology ensures complete elimination of non-specific binding sites on the silica surface. The rigidity of silica particles enables the columns to be used under high performance chromatographic conditions as well as for routine low-pressure applications.

Special feature:

Highly stable bonded phase for efficient purification of antibodies.

Separation of Antibodies

Column: CIBProteinA-10-300/5
Solutes: 1=IgG
Eluent: A=PBS buffer, pH 7.4 B=Citric acid, pH 2.7
100%A - 100%B - 100%A Stepwise gradient in 18 min
Flow: 1.0 mL/min
Detector: UV; 280nm
Temp: 30°C

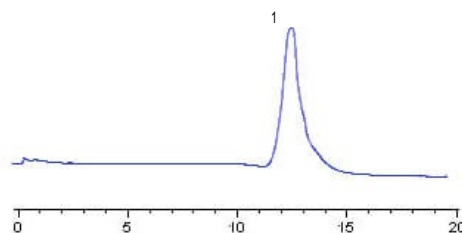

Ordering Information

SMT CIB-ProteinA - Columns 5 µm, 100Å

*Column Dimension (length x i.d.)
50mmx4.6mm
100mmx4.6mm

Catalog Number
CIBProteinA-5-100/5
CIBProteinA-5-100/10

SMT CIB-ProteinA - Columns 10 µm, 100Å

*Column Dimension (length x i.d.)
50mmx4.6mm
100mmx4.6mm

Catalog Number
CIBProteinA-10-100/5
CIBProteinA-10-100/10

*Guard column: 20mmx4.0mm; add suffix G to Catalog Number
+Other dimensions available; Please contact SMT, Inc. for quotation

SMT CIB-IgG Columns & Applications

SMT CIB-IgG are silica-based packing materials designed for both high performance and low-pressure purification of protein A. In production of the IgG affinity-type columns, SMT utilizes its proprietary technique of self-assembled monolayer (SAM) of bonding to first immobilize unique mixed phases of appropriate silane ligands that are capable of effectively anchoring IgG on silica substrates. This total coverage™ technology ensures complete elimination of non-specific binding sites on the silica surface. The rigidity of silica particles enables the columns to be used under high performance chromatographic conditions as well as for routine low-pressure applications.

Special feature:

- Highly stable bonded phase for efficient purification of antibodies.

Purification of ProteinA

Column: CIBIgG-10-300/5
Solute: 1=ProteinA phage mixture
100%A - 100%B - 100%A Stepwise gradient in 12.5 min
Flow: 1.0 mL/min
Detector: UV; 280nm
Temp: 30°C

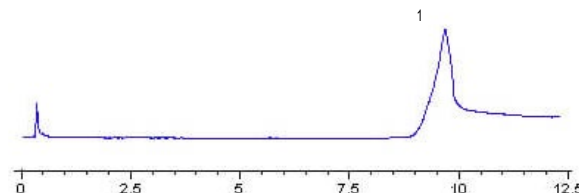

Ordering Information

SMT CIB-IgG - Columns 5 µm, 100Å

*Column Dimension (length x i.d.)	Catalog Number
50mmx4.6mm	CIBIgG-5-100/5
100mmx4.6mm	CIBIgG-5-100/10

*Guard column: 20mmx4.0mm; add suffix G to Catalog Number
+Other dimensions available; Please contact SMT, Inc. for quotation

SMT CIB-IgG - Columns 10 µm, 100Å

*Column Dimension (length x i.d.)	Catalog Number
50mmx4.6mm	CIBIgG-10-100/5
100mmx4.6mm	CIBIgG-10-100/10

SMT CIB-Ovomucoid Columns & Applications

SMT manufactures the first series of commercially available silica based CIB-Ovomucoid columns for high performance chiral separation of acid, base and neutral molecules. This total coverage™ technology ensures complete elimination of non-specific binding sites on the silica surface. The rigidity of silica particles enables the columns to be used under high performance chromatographic application and the stability of the bonded phase results in efficient resolution of chiral acidic, basic and neutral molecules.

Special features:

- Simplicity of elution without gradient
- High resolution.

Separation of + & - Ketoprofen

Column: CIBOVO-5-100/15
Solute: + & - Ketoprofen
Eluent: 0.2M Phosphate Buffer pH=6/ACN 10:90 (v:v)
Flow: 1.0 mL/min
Detector: UV; 220nm
Temp: 30°C

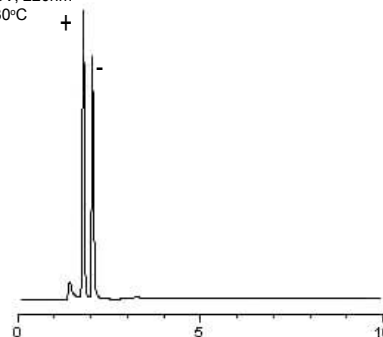

Ordering Information

SMT CIB-Ovomucoid Columns 5 µm, 100Å

150mmx4.6mm	CIBOVO-5-100/15
250mmx4.6mm	CIBOVO-5-100/25

*Guard column: 20mmx4.0mm; add suffix G to Catalog Number
+Other dimensions available; Please contact SMT, Inc. for quotation

SMT ChiralSep Columns

Chiral compounds, or enantiomers have identical molecular structures that are related as mirror images of one another much like a left hand is related to a right hand. Rapid and accurate stereochemical resolution of enantiomeric molecules has become a challenge in various aspects of pharmaceuticals and drug discoveries.

A chiral column may contain one form of an enantiomeric compound immobilized on the surface of a packing material.

Special features for adequate separation with chiral columns:

- At least three points of simultaneous interaction between the chiral phase and one analyte enantiomer, with at least

one point of stereochemical dependence.

- One of the enantiomers have differing degrees of interaction with the stationary phase, so that one will be more strongly retained than the other.

SMT manufactures ultra-stable chiral columns for normal and reversed-phase chromatographic separation modes. SMT uses derivatives of optically active polysaccharides that are chemically bonded on silica in the synthesis of its ChiralSep packings. Bimodal separation is made possible due to the nature of the chiral surface and the proprietary SAM bonding technique that ensures strong chemical linkage between the chiral ligand and the silica substrate.

SMT ChiralSep1 Columns & Applications

SMT ChiralSep1 utilizes SAM of a proprietary chiral ligand on cellulose immobilized on silica substrate.

Column: ChiralSep1-5-300/15
Solutes: 1 & 2 = racemic Ketoprofen
Eluent: Heptane: 2-PrOH + 0.1% TFA; 98:2 (v:v)
Flow: 1.0 mL/min
Detector: UV; 254nm
Temp: 30°C

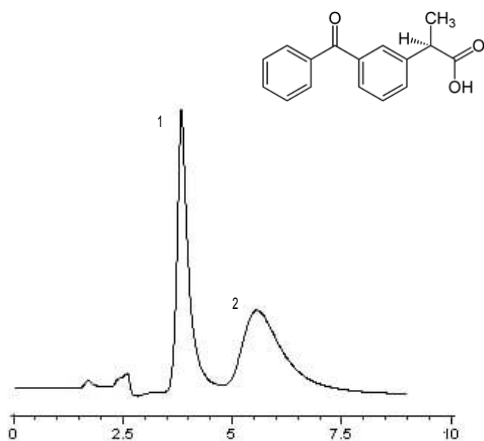

Column: ChiralSep1-5-100/15
Solutes: 1 & 2 = racemic Pindolol
Eluent: ACN:NaClO₄ aq 0.1M; 40:60 (v:v)
Flow: 1.0 mL/min
Detector: UV; 254nm
Temp: 30°C

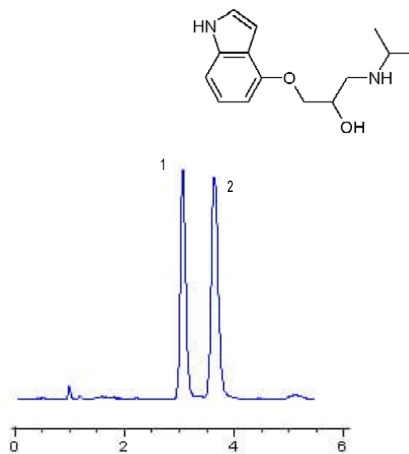

Ordering Information

SMT ChiralSep1 - Columns 5 µm, 100Å

*Column Dimension (length x i.d.)	Catalog Number
150mmx4.6mm	ChiralSep1-5-100/15
250mmx4.6mm	ChiralSep1-5-100/25

SMT ChiralSep1 - Columns 10 µm, 100Å

*Column Dimension (length x i.d.)	Catalog Number
150mmx4.6mm	ChiralSep1-10-100/15
250mmx4.6mm	ChiralSep1-10-100/25

SMT ChiralSep1 - Columns 5 µm, 300Å

*Column Dimension (length x i.d.)	Catalog Number
150mmx4.6mm	ChiralSep1-5-300/15
250mmx4.6mm	ChiralSep1-5-300/25

SMT ChiralSep1 - Columns 10 µm, 300Å

*Column Dimension (length x i.d.)	Catalog Number
150mmx4.6mm	ChiralSep1-10-300/15
250mmx4.6mm	ChiralSep1-10-300/25

*Guard column: 20mmx4.0mm; add suffix G to Catalog Number
*Other dimensions available; Please contact SMT, Inc. for quotation

SMT ChiralSep Columns

SMT ChiralSep2 Columns & Applications

SMT ChiralSep2 utilizes SAM of a proprietary chiral ligand on cellulose immobilized on silica substrate.

Column: ChiralSep2-10-100/15
Solutes: 1 & 2 = racemic Larazepam
Eluent: ACN: Water; 60:40 (v:v)
Flow: 1.0 mL/min
Detector: UV; 254nm
Temp: 30°C

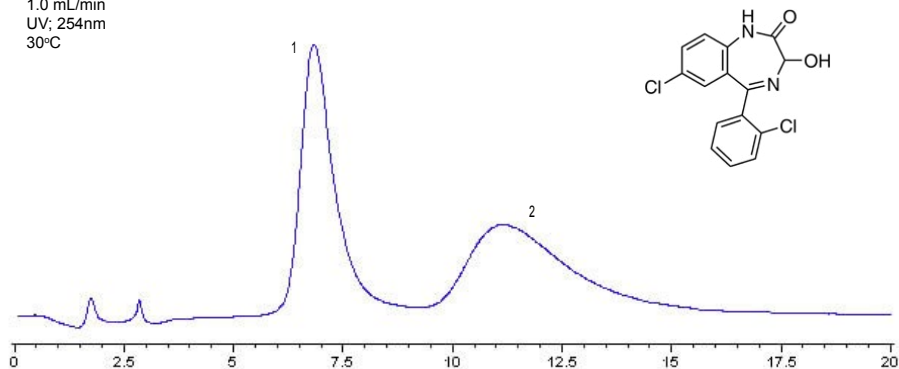

Column: ChiralSep2-5-100/15
Solutes: 1 & 2 = racemic Naproxen
Eluent: Heptane: 2-PrOH + 0.1% TFA; 98:2 (v:v)
Flow: 1.0 mL/min
Detector: UV; 254nm
Temp: 30°C

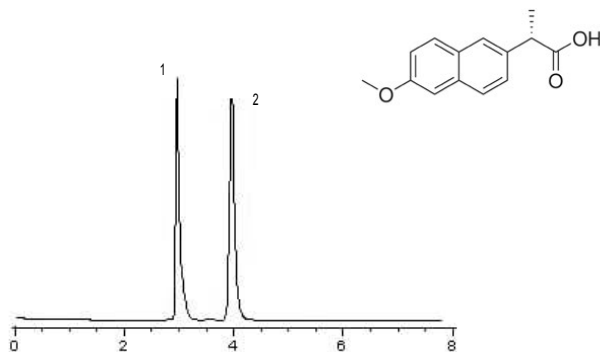

Ordering Information

SMT ChiralSep2 - Columns 5 µm, 100Å

*Column Dimension (length x i.d.)	Catalog Number
150mmx4.6mm	ChiralSep2-5-100/15
250mmx4.6mm	ChiralSep2-5-100/25

SMT ChiralSep2 - Columns 10 µm, 100Å

*Column Dimension (length x i.d.)	Catalog Number
150mmx4.6mm	ChiralSep2-10-100/15
250mmx4.6mm	ChiralSep2-10-100/25

SMT ChiralSep2 - Columns 5 µm, 300Å

*Column Dimension (length x i.d.)	Catalog Number
150mmx4.6mm	ChiralSep2-5-300/15
250mmx4.6mm	ChiralSep2-5-300/25

SMT ChiralSep2 - Columns 10 µm, 300Å

*Column Dimension (length x i.d.)	Catalog Number
150mmx4.6mm	ChiralSep2-10-300/15
250mmx4.6mm	ChiralSep2-10-300/25

*Guard column: 20mmx4.0mm; add suffix G to Catalog Number
+Other dimensions available; Please contact SMT, Inc. for quotation

SMT SEC Columns & Applications

SMTgel™ (silica-based) columns are specialty SMT columns designed for specific applications including gel permeation (GPC), ion exchange, reversed phase, hydrophobic interaction, hydrophilic interaction, and affinity chromatography. SMTgel™ columns are packed with chemically modified silica particles with functional molecules for specific applications and pore sizes to accommodate wide range of analyte molecular weights. The packing materials feature modified surface chemistry designed to minimize sample adsorption on the silica substrate. All popular biomolecule separation modes are covered by SMTgel™ (silica-based) columns. Because SMTgel™ columns are silica-based, they must be operated within the recommended pH range of 2.0 – 9.0. Detailed operating conditions are described in the information accompanying the columns. We recommend protecting these columns with the appropriate SMTgel™ guard column.

SMTgel RP

SMTgel RP are available in wide selection of pore sizes, from 300A to 2000A. For example, SMTgel 300RP, 1000RP, and 2000RP are packed with rigid, porous, 300A, 1,000A, and 2,000 A, of chemically modified silica gel with nonpolar ligands, respectively. They can be used for the both normal and reversed phase separation of oligomers and polymers up to 100,000 Da Molecular Weight. SMTgel RP columns are shipped in Acetonitrile/water or methanol/water, which can be exchanged for a wide variety of other organic/water solvents. SMTgel RP columns are ideal for gel permeation chromatography and are stable in solvents having a wide range of polarities. The particles DO NOT swell or shrink as the solvent is changed from common organic solvents like toluene through methanol or other solvents. Further-

more, these columns can be used with polar solvents, such as water or water/methanol mixtures. These columns are available in spherical 5 and 10 µm particle sizes. Spherical 5 µm silica particles provide a minimum of 20,000 plates per 30 cm x 7.8 mm I.D. column. Four pore sizes are available, ranging from an exclusion limit of about 2,000 Daltons for 300RP columns to more than 500,000 Daltons for 2000RP columns.

Four different modifications:

- RP1
- RP2
- RP3
- RP4

are made available through changes in the non-polar characteristics of the SMTgel packing material with RP1 being the least non-polar of the four. Specialty mixed bed columns are also available as they feature extended linear molecular weight operating ranges for sample screening or more challenging analyses.



Ordering Information

SMTgel 300RP1 - Columns 5 µm, 300Å

*Column Dimension (length x i.d.)	Catalog Number
300mmx7.8mm	SMTgel-5-300RP1/307.8
300mmx10mm	SMTgel-5-300RP1/3010

SMTgel 300RP3 - Columns 5 µm, 300Å

*Column Dimension (length x i.d.)	Catalog Number
300mmx7.8mm	SMTgel-5-300RP3/307.8
300mmx10mm	SMTgel-5-300RP3/3010

SMTgel 1000RP1 - Columns 5 µm, 1,000Å

*Column Dimension (length x i.d.)	Catalog Number
300mmx7.8mm	SMTgel-5-1000RP1/307.8
300mmx10mm	SMTgel-5-1000RP1/3010

SMTgel 1000RP3 - Columns 5 µm, 1,000Å

*Column Dimension (length x i.d.)	Catalog Number
300mmx7.8mm	SMTgel-5-1000RP3/307.8
300mmx10mm	SMTgel-5-1000RP3/3010

SMTgel 2000RP1 - Columns 5 µm, 2,000Å

*Column Dimension (length x i.d.)	Catalog Number
300mmx7.8mm	SMTgel-5-2000RP1/307.8
300mmx10mm	SMTgel-5-2000RP1/3010

SMTgel 2000RP3 - Columns 5 µm, 2,000Å

*Column Dimension (length x i.d.)	Catalog Number
300mmx7.8mm	SMTgel-5-2000RP3/307.8
300mmx10mm	SMTgel-5-2000RP3/3010

*Guard column: 20mmx4.0mm; add suffix G to Catalog Number
+Other dimensions available; Please contact SMT, Inc. for quotation

SMTgel 300RP2 - Columns 5 µm, 300Å

*Column Dimension (length x i.d.)	Catalog Number
300mmx7.8mm	SMTgel-5-300RP2/307.8
300mmx10mm	SMTgel-5-300RP2/3010

SMTgel 300RP4 - Columns 5 µm, 300Å

*Column Dimension (length x i.d.)	Catalog Number
300mmx7.8mm	SMTgel-5-300RP4/307.8
300mmx10mm	SMTgel-5-300RP4/3010

SMTgel 1000RP2 - Columns 5 µm, 1,000Å

*Column Dimension (length x i.d.)	Catalog Number
300mmx7.8mm	SMTgel-5-1000RP2/307.8
300mmx10mm	SMTgel-5-1000RP2/3010

SMTgel 1000RP4 - Columns 5 µm, 1,000Å

*Column Dimension (length x i.d.)	Catalog Number
300mmx7.8mm	SMTgel-5-1000RP4/307.8
300mmx10mm	SMTgel-5-1000RP4/3010

SMTgel 2000RP2 - Columns 5 µm, 2,000Å

*Column Dimension (length x i.d.)	Catalog Number
300mmx7.8mm	SMTgel-5-2000RP2/307.8
300mmx10mm	SMTgel-5-2000RP2/3010

SMTgel 2000RP4 - Columns 5 µm, 2,000Å

*Column Dimension (length x i.d.)	Catalog Number
300mmx7.8mm	SMTgel-5-2000RP4/307.8
300mmx10mm	SMTgel-5-2000RP4/3010

USP-Column Designations & SMT-Columns

The following chart has been provided as a guide to selecting SMT-HPLC columns which meet the specifications set forth in the United States Pharmacopeia [USP], which provides guidelines for the separation of related compounds.

It is important to note that, in many cases, USP column specifications are so broad that several (or many) column types actually meet the basic specifications. For example, L1 specification calls for a column consisting of silica packing material, 5 or 10µm in diameter, bonded with octadecyl (C18) silane. However, a limited number of available C18 columns will actually perform the desired separation.

SMT offers a variety of columns for each category. These columns are representative of the wide range of selectivities available for each bonded phase. The packing materials vary in particle size, pore size, surface area, carbon load, hydrophobicity, bonded phase coverage or density, and other characteristics. Refer to the catalog for description and characteristics of a specific column of interest.

Ordering Information

USP - Columns are available in various configurations. Available stock sizes include 4.6x150mm and 4.6x250mm.

(Please refer to the catalog for description and characteristic of specific column)

Particle sizes: 3-10µm

Pore sizes: 60, 100, 300Å



Column	Description	SMT Column
L1	Octadecyl silane chemically bonded on 1.5-10µm porous silica	SMT-OD SMT-ODL Elite-C18
L3	5-10µm porous silica	SMT- S
L7	Octyl silane chemically bonded on 3-10µm porous silica	SMT-O SMT-OL Elite-C8
L8	NH ₂ on 10µm porous silica	SMT-AP
L9	SCX on 10µm porous silica	SMT-SCX
L10	CN on 3-10µm porous silica	SMT-CP
L11	Phenyl on 5-10µm porous silica	SMT-Phen1 SMT-Phen2
L12	SAX on 30-50µm porous silica	SMT-SAX
L13	C1 on 3-10µm porous silica	SMT-MEB1
L14	SAX on 10µm porous silica	SMT-SAX
L15	C6 on 3-10µm porous silica	SMT-C6 , SMT-H
L16	Dimethyl silane chemically bonded to 3 to 10µm porous silica	SMT-MEB1DM
L20	Diol on 3-10µm porous silica	SMT-DIOL2
L26	C4 on 5-10µm porous silica	SMT-MEB4
L27	30-50µm porous silica	SMT-S
L30	Ethyl silane chemically bonded to 3-10µm porous silica	SMT-MEB2
L40	Cellulose tris-3,5-dimethylphenylcarbamate bonded on porous silica, 5-20µm	SMT-ChiralSep1
L41	Immobilized alpha-acid glycoprotein on silica, 5µm	SMT-ChiralSepAGP
L42	Octyl and Octadecyl silane chemically bonded to porous silica	SMT-ODO
L43	Pentafluorophenyl groups chemically bonded to silica particles 5 to 10µm in diameter	SMT-C6F5
L52	Strong Cation Exchange resin made of porous silica with sulfopropyl groups, 5 to 10µm in diameter	SMT-SCX
L56	isoPropyl silane chemically bonded to 3 to 10µm porous silica	SMT-iPr
L57	Chiral recognition protein, ovomucoid, chemically bonded to silica particles, about 5 µm in diameter, with pore size of 120Å	SMT CIB Ovomucoid
L62	C30 on 5-10µm porous silica	SMT-TA
Unclassified	Dodecyl silane bonded on 5-50µm silica	SMT-DD
"	Proprietary strong cation exchange on 5-50µm Porous silica	MetalSep

SMT Micro/Narrow Bore Columns & Applications

Micro and narrow bore columns are nonstandard columns designed for special HPLC applications (such as LC/MS and LC/GC). The SMT microbores are referred to as all columns that have internal diameters (id) of 1.0mm or less. SMT narrow bore columns have id of 2.0 to 3.0 mm.

Micro and narrow bore columns are generally not recommended for usage on normal configuration HPLC systems. Modification of system configuration with regards to pumping, injecting, flow cell, and detecting, are often crucial. Compared with standard columns (4.6mm, id), Micro and narrow-bore columns provide:

Special features:

- Greatly enhanced sensitivity
- Dramatic solvent savings, without altering the resolution and retention values.
- Ideal for applications in which very small quantities of sam-

ples are available for analysis.

- Favorite choice for applications in LC/MS
- Better choice for applications in drug discoveries and screening
- Ideal for applications in genomics and proteomics

Microbore HPLC columns require the use of a specialized, dedicated microbore HPLC system, equipped with a very low-volume injector, low-volume detector flow cell, micro pump heads capable of delivering low flow rates, and small-bore connective tubings. SMT manufactures micro and narrow bore columns of outstanding efficiency and durability. These columns have found tremendous number of applications in LC/MS (liquid chromatography/mass spectroscopy), especially in the area of drug discoveries.

Probe solutes on Micro/Narrow Bore columns

Column: A=OD-5-100/152

B=OD-5-100/15

Solutes:

- 1=uracil
- 2=benzene
- 3=toluene
- 4=naphthalene
- 5=isobutyl benzene
- 6=anthracene

Eluent:

ACN: Water 60:40 (v:v)

Flow:

1.0 mL/min

Detector:

UV; 254nm

Temp:

30°C

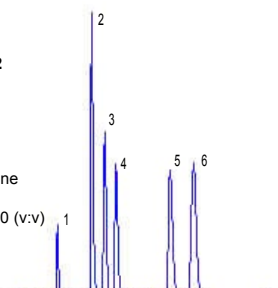

Enhanced Sensitivity

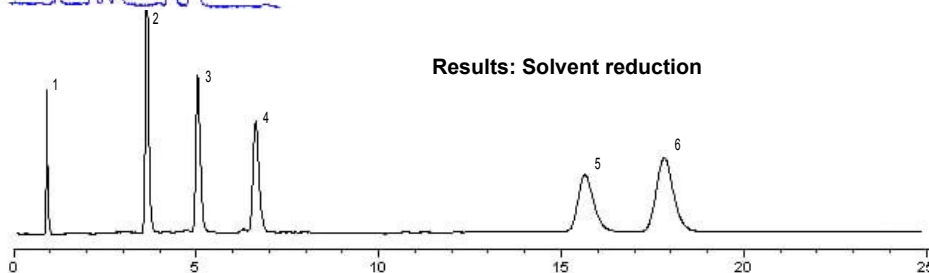

Results: Solvent reduction

Ordering Information

SMT C18 - Columns 5 µm, 100Å

* Column Dimension (length x i.d.)

50mmx1.0mm

150mmx1.0mm

250mmx1.0mm

Catalog Number

OD-5-100/51

OD-5-100/151

OD-5-100/251

SMT C18 - Columns 5 µm, 100Å

* Column Dimension (length x i.d.)

50mmx2.0mm

150mmx2.0mm

250mmx2.0mm

Catalog Number

OD-5-100/52

OD-5-100/152

OD-5-100/252

SMT C18 - Columns 5 µm, 100Å

* Column Dimension (length x i.d.)

50mmx3.0mm

150mmx3.0mm

250mmx3.0mm

Catalog Number

OD-5-100/53

OD-5-100/153

OD-5-100/253

SMT C18 - Columns 5 µm, 100Å

* Column Dimension (length x i.d.)

50mmx3.9mm

150mmx3.9mm

250mmx3.9mm

Catalog Number

OD-5-100/54

OD-5-100/154

OD-5-100/254

SMT C18 - Columns 5 µm, 300Å

* Column Dimension (length x i.d.)

50mmx1.0mm

150mmx1.0mm

250mmx1.0mm

Catalog Number

OD-5-300/51

OD-5-300/151

OD-5-300/251

SMT C18 - Columns 5 µm, 300Å

* Column Dimension (length x i.d.)

50mmx2.0mm

150mmx2.0mm

250mmx2.0mm

Catalog Number

OD-5-300/52

OD-5-300/152

OD-5-300/252

SMT C18 - Columns 5 µm, 300Å

* Column Dimension (length x i.d.)

50mmx3.0mm

150mmx3.0mm

250mmx3.0mm

Catalog Number

OD-5-300/53

OD-5-300/153

OD-5-300/253

SMT C18 - Columns 5 µm, 300Å

* Column Dimension (length x i.d.)

50mmx3.9mm

150mmx3.9mm

250mmx3.9mm

Catalog Number

OD-5-300/54

OD-5-300/154

OD-5-300/254

* Similar configurations available for other packagings; Please contact SMT, Inc. for assistance

SMT UHPLC - Columns

SMT SAM-UHPLC® columns are the most technologically advanced LC columns ever created, combining faster separations with higher resolution by harnessing the full potential of small particles. Designed, tested, and guaranteed for use in applications up to 15000 psi (1000 bar), these columns offer unsurpassed efficiency, ruggedness and throughput.

Perhaps the most important feature of UHPLC column is the tremendous savings in analytical time and solvent con-

sumptions as well as cost of disposal of used solvents in analytical method development process.

SMT UHPLC columns are available in various bonded-phases (C18, C8, MEB, CN, NH₂, Phenyl, Diol, etc.) and in more than 100 combinations of configurations, column dimensions, chemistries and offerings in:

- 1.5 µm UPLC particles
- 1.8 µm UPLC particles

UHPLC Separation of Peptides

Column: OD-1.8-100/52 vs Agilent
 Solutes: 1. TYR_GLY
 2. GLY_GLY_PHE
 3. GLY_LEU_TYR
 Eluent: ACN: Water 70:30 (v:v)
 Flow: 0.10 mL/min
 Detector: UV; 254nm
 Temp: 30°C

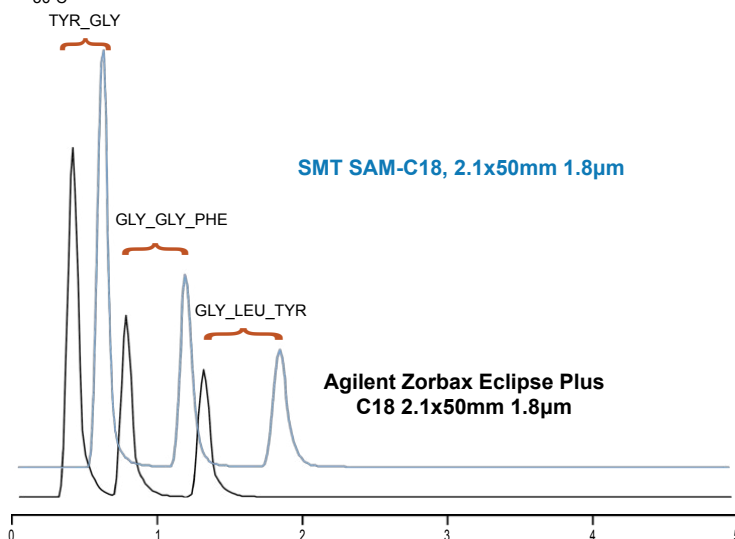

Chromatographic data donated from Dr. Derrick Swinton,
 Department of Chemistry, Lincoln University, PA

Ordering Information

SMT SAM-C18 - Columns 1.5 µm, 100Å

* Column Dimension (length x i.d.)	Catalog Number
20mmx4.6mm	OD-1.5-100/2
30mmx4.6mm	OD-1.5-100/3
50mmx4.6mm	OD-1.5-100/5
75mmx4.6mm	OD-1.5-100/7.5
100mmx4.6mm	OD-1.5-100/10
* Column Dimension (length x i.d.)	Catalog Number
20mmx2.1mm	OD-1.5-100/22
30mmx2.1mm	OD-1.5-100/32
50mmx2.1mm	OD-1.5-100/52
75mmx2.1mm	OD-1.5-100/7.52
100mmx2.1mm	OD-1.5-100/102

SMT SAM-C18 - Columns 1.8 µm, 100Å

* Column Dimension (length x i.d.)	Catalog Number
20mmx4.6mm	OD-1.8-100/2
30mmx4.6mm	OD-1.8-100/3
50mmx4.6mm	OD-1.8-100/5
75mmx4.6mm	OD-1.8-100/7.5
100mmx4.6mm	OD-1.8-100/10
* Column Dimension (length x i.d.)	Catalog Number
20mmx2.1mm	OD-1.8-100/22
30mmx2.1mm	OD-1.8-100/32
50mmx2.1mm	OD-1.8-100/52
75mmx2.1mm	OD-1.8-100/7.52
100mmx2.1mm	OD-1.8-100/102

SMT SAM-C8 - Columns 1.5 µm, 100Å

* Column Dimension (length x i.d.)	Catalog Number
20mmx4.6mm	O-1.5-100/2
30mmx4.6mm	O-1.5-100/3
50mmx4.6mm	O-1.5-100/5
75mmx4.6mm	O-1.5-100/7.5
100mmx4.6mm	O-1.5-100/10
* Column Dimension (length x i.d.)	Catalog Number
20mmx2.1mm	O-1.5-100/22
30mmx2.1mm	O-1.5-100/32
50mmx2.1mm	O-1.5-100/52
75mmx2.1mm	O-1.5-100/7.52
100mmx2.1mm	O-1.5-100/102

SMT SAM-C8 - Columns 1.8 µm, 100Å

* Column Dimension (length x i.d.)	Catalog Number
20mmx4.6mm	O-1.8-100/2
30mmx4.6mm	O-1.8-100/3
50mmx4.6mm	O-1.8-100/5
75mmx4.6mm	O-1.8-100/7.5
100mmx4.6mm	O-1.8-100/10
* Column Dimension (length x i.d.)	Catalog Number
20mmx2.1mm	O-1.8-100/22
30mmx2.1mm	O-1.8-100/32
50mmx2.1mm	O-1.8-100/52
75mmx2.1mm	O-1.8-100/7.52
100mmx2.1mm	O-1.8-100/102

*Guard column: available; add suffix G to Catalog Number
 +Other dimensions available; Please contact SMT, Inc. for quotation

SMT HPLC Guard Columns & Applications

Guard columns are expendable small columns designed to remove anything that may interfere with the separation or shorten the lifetime of the primary column. A standard HPLC column (analytical or preparative) is hereby referred to as the primary because it is first in value and in importance for separation.

Guard columns are utilized to remove:

- Particles that may clog the primary column and necessitate a frit change, which can be cumbersome.
- Compounds, including ions, that may adsorb strongly on the packing material and cause baseline drift, spurious peaks, loss of resolution and change in selectivity
- Compounds that can form a precipitate upon contact with mobile phase or packing
- Compounds that may co-elute with analyte and interfere with its detection and quantitation.

SMT guard is designed to have minimal or no effect on separation, as shown in Figure 2. The concept is verified by injection of standards before and after guard installation. The small increase in retention is due to the added packing materials in the guard device. In Figure 2, the column performance and peak symmetry are not altered in the separation because SMT guard is packed with the same pressure as the primary column and has minimal void volume design as shown in Figure 1. Because of the way it is packed, the guard can also be used alone as an analytical column.



Figure 1: SMT minimal void Guard column

Ordering Information

Guard Column dimensions: 10mm x 4.0mm;
Add suffix G to catalog# for complete guard column assembly
Add suffix GI for guard column insert only

SMT HPLC Guard Columns are available in all column packing materials.
Available stock size includes 4.0mm i.d x 10mm length

Effect of Guard Column in Separation

Column: A=OD-5-100/15
B=A+OD-5-100G
Solutes: 1=uracil
2=benzene
3=hexanophenone
4=anthracene
Eluent: ACN: Water 70:30 (v:v)
Flow: 1.0 mL/min
Detector: UV; 254nm
Temp: 30°C

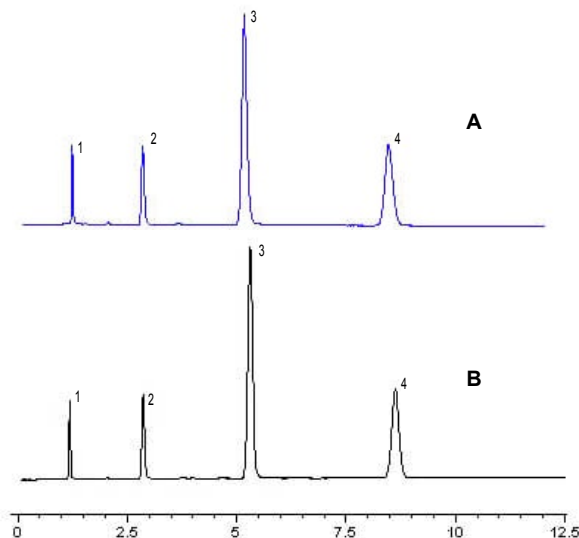

Figure 2



SMT Guard column with Primary Column assembly

SMT Analytical to Semi-Prep & Prep Columns

SMT's C18 and C8 columns are very stable at extreme pH conditions and high temperatures. C18 and C8 columns are strongly recommended for the separation of most basic, acidic and neutral compounds. C8 is usually the second choice after C18 for method developments using reversed-phase chromatographic separation. Although C18 remains the most widely used, the use of the C8 phase has increased in recent years and represents a good compromise phase. C8 phase normally provides equivalent selectivity; it is not too hydrophobic, and yet it retains many compounds on the basis of interaction with their hydrophobic groups. C8 phases are good choices when too much organic solvent is required to elute the analytes of interest (especially highly hydrophobic molecules) from a C18 phase. The use of C8 packings reduces retention time and consumption of organic solvents. Other stationary phases of interest available for these applications include SMT MEB, C3, C5, C6, C12 and C30.

Special features:

- Ultra Stable phases for Semi-prep and prep-scale purification
- Very high Carbon load
- pH stability from 1 to 12
- Stable when used at high temperature
- Very high silanol site coverage vs competitor's 30-50%



Semi-Prep & Prep Purifications

Column: A=OD-10-100/25
B=OD-10-100/2510
C=OD-10-100/2522

Solutes: 1=uracil
2=benzene

Eluent: ACN: Water 70:30 (v:v)

Flow: A at 1.0 mL/min, B at 2.0 mL/min, C at 3.0 mL/min

Detector: UV; 254nm

Temp: 30°C

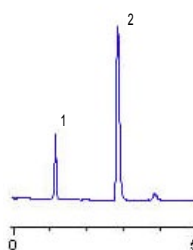

A

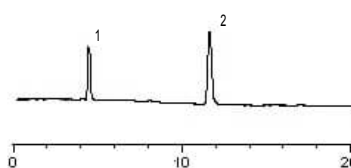

B

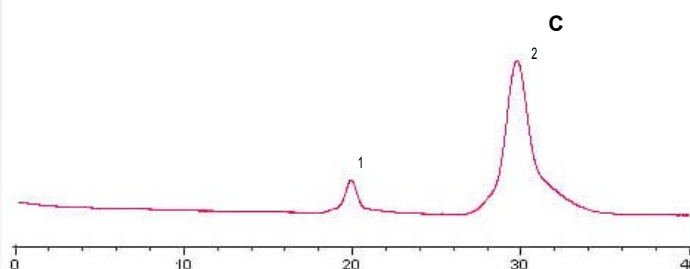

C

Ordering Information

SAM-C18 (OD-columns) 5 µm, 100Å

* Column Dimension (length x i.d.)

150mmx7.8mm
250mmx7.8mm
300mmx7.8mm

Catalog Number
OD-5-100/157.8
OD-5-100/257.8
OD-5-100/307.8

SAM-C18 (OD-columns) 10 µm, 100Å

* Column Dimension (length x i.d.)

150mmx7.8mm
250mmx7.8mm
300mmx7.8mm

Catalog Number
OD-10-100/157.8
OD-10-100/257.8
OD-10-100/307.8

SAM-C18 (OD-columns) 5 µm, 100Å

* Column Dimension (length x i.d.)

150mmx10mm
250mmx10mm
300mmx10mm

Catalog Number
OD-5-100/1510
OD-5-100/2510
OD-5-100/3010

SAM-C18 (OD-columns) 10 µm, 100Å

* Column Dimension (length x i.d.)

150mmx10mm
250mmx10mm
300mmx10mm

Catalog Number
OD-10-100/1510
OD-10-100/2510
OD-10-100/3010

SAM-C18 (OD-columns) 5 µm, 100Å

* Column Dimension (length x i.d.)

150mmx22.1mm
250mmx22.1mm

Catalog Number
OD-5-100/1522
OD-5-100/2522

SAM-C18 (OD-columns) 10 µm, 100Å

* Column Dimension (length x i.d.)

150mmx22.1m
250mmx22.1mm

Catalog Number
OD-10-100/1522
OD-10-100/2522

Guard column: available; add suffix G to Catalog Number

+Other dimensions available; Please contact SMT, Inc. for quotation

SMT Process & Low Pressure Columns

SMT's column packing materials are very stable at extreme pH conditions and high temperatures. SMT C18 HPLC columns (e.g. OD-5-100, OD-10-100, and other OD-series), for example, have been widely utilized in separation of many basic, acidic and neutral compounds in various analytical method developments in major laboratories in United States and all around the world. SMT bulk-C18 packing materials (e.g. BOD-35-150, BOD-35-60 and other reversed phase bulk) have also been used as part of large scale purification of organic dyes and many other compounds of interest. Similar idea can be easily extended to process scale purification needs. However, the cost of such applications can be extremely high. SMT provides bulk packing materials with exceptional characteristics at much reasonable costs for process scale and low pressure chromatographic analysis. These packing materials are made with irregular silica substrates with comparable pore sizes with analytical and prep columns. The silica particles are relatively larger in sizes and provided with narrow size distribution range in order to ensure adequate flow of the mobile phase through the columns without need for high pressure pumps. End-users are able to design in-house columns for various applications of interest. SMT provides custom columns and cartridge sizes to meet individual needs of end-users.



Special features:

- Ultra Stable phases for bulk and process-scale purification
- Very high Carbon load
- Highly stable bed
- Usable at extended temperatures
- pH stability from 1 to 12
- Very high silanol site coverage vs competitor's 30-50%
- Perfect for Solid Phase Extraction and Process Scale purifications
- Ideal for applications in flash cartridges of various sizes
- Reduces manufacturing costs



Ordering Information

SMT Bulk-C18 Columns/Packings 35-60 μm , 60 \AA

*Product size (mass)	Catalog Number
100 g	BOD-35-60/100G
500 g	BOD-35-60/500G
5 kg	BOD-35-60/5KG
10 kg	BOD-35-60/10KG

SMT Bulk-C8 Columns/Packings 35-60 μm , 60 \AA

*Product size (mass)	Catalog Number
100 g	BO-35-60/100G
500 g	BO-35-60/500G
5 kg	BO-35-60/5KG
10 kg	BO-35-60/10KG

SMT Bulk-C18 Columns/Packings 35-60 μm , 150 \AA

*Product size (mass)	Catalog Number
100 g	BOD-35-150/100G
500 g	BOD-35-150/500G
5 kg	BOD-35-150/5KG
10 kg	BOD-35-150/10KG

SMT Bulk-C8 Columns/Packings 35-60 μm , 150 \AA

*Product size (mass)	Catalog Number
100 g	BO-35-150/100G
500 g	BO-35-150/500G
5 kg	BO-35-150/5KG
10 kg	BO-35-150/10KG

*SMT Bulk-C18 and Bulk-C8 packings are available in bulk quantities of 100 g, 250 g, 250g, 500 g, 5 kg, 10 kg.

For larger quantities call for a price quote

Silica gel and Bulk Packing materials for process scale applications are available in various particle and pore sizes: 10, 20, 35, 60 μm and 60, 100, 150, and 300 \AA are stock sizes

SMT Bulk Packing Materials for Scale-up Purifications

SMT total coverage™ packings are designed for usage from analytical to process scale purification. The primary purpose for analytical method developments in pharmaceutical and food industries is for subsequent process scale purification. The analytical steps are used to reduce the cost incurable in erroneous large-scale purification steps. SMT is a specialty column company, and as such, offers services that can greatly enhance scale-up of many analytical methods development. Bulk samples are offered for your initial evaluation. SMT offers a variety of packing materials in bulk quantities for reversed-phase, normal phase, and ion exchange chromatography. These B- series bulk packing materials usually consist of silica substrates and are made with total coverage technology and guaranteed to last much longer than competitor's silica-based packings. Polymer-based packings are made available for special applications that require use in extreme pH conditions (such as pH=14).

Special features:

- Extremely High Coverage vs Competitor's 30-50%
- Highest levels of Consistency and Reproducibility
- Wide range of pH stability (e.g. 1 to 12 for C18)
- High throughput - No carry over of any analytes
- Low back pressure
- Improved Resolution
- Perfect for Solid Phase Extraction and Process Scale purifications
- Ideal for applications in flash cartridges of various sizes

Silica gel and Bulk Packing materials for process scale applications are available in various particle sizes and pore sizes: 10, 20, 35, 60 µm and 60, 100, 150 and 300 Å are stock sizes.

The packings are available in bulk quantities of 100 grams, 500 grams, 1 kg, 5 kg, 10 kg, and 25 kg sizes. For larger quantities call for a price quote.

Ordering Information

SAM-C8 (BO-columns) 32-65 µm, 60Å

*Product size (mass)	Catalog Number
500 g	BO-35-60/500G
1 kg	BO-35-60/1KG
5 kg	BO-35-60/5KG
10 kg	BO-35-60/10KG
25 kg	BO-35-60/25KG
50 kg	BO-35-60/50KG

SAM-C18 (BOD-columns) 32-65 µm, 150Å

*Product size (mass)	Catalog Number
500 g	BOD-35-150/500G
1 kg	BOD-35-150/1KG
5 kg	BOD-35-150/5KG
10 kg	BOD-35-150/10KG
25 kg	BOD-35-150/25KG
50 kg	BOD-35-150/50KG

*SMT Bulk-C18 and Bulk-C8 packings are available in bulk quantities of 100 g, 250 g, 500 g, 5 kg, 10 kg, 25 kg, and 50 kg
For larger quantities call for a price quote
Silica gel and Bulk Packing materials for process scale applications are available in various particle and pore sizes:
10, 20, 35, 60µm and 60, 100, 150, and 300Å are stock sizes



Bulk Purification of Organic Compounds

Column: **A=BOD-35-150/25** (Column hand-packed for Low Pressure LC)
B=OD-5-100/25 (Column packed at high pressure for LC)
Solutes: 1=Uracil
2=Naphthalene
Eluent: ACN: Water 70:30 (v:v)
Flow: 1.0 mL/min
Detector: UV; 254nm
Temp: 30°C

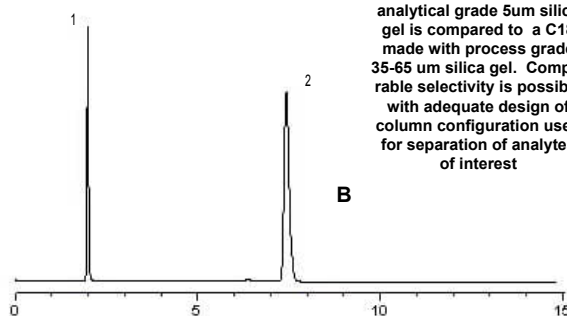
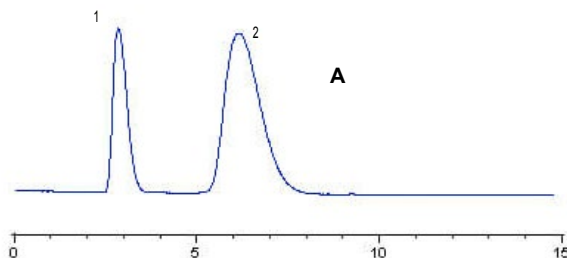

Packing materials consisting of C18 made with analytical grade 5µm silica gel is compared to a C18 made with process grade 35-65 µm silica gel. Comparable selectivity is possible with adequate design of column configuration used for separation of analytes of interest

SMT Specialty Bulk Packing Materials for Bio & Nanotechnologies

SMT is a research and manufacturing corporation with continuous interest in molecular architectures on surfaces. SMT uses SAM technology to develop new nano-scale materials and processes that could fundamentally alter the way we live, by transforming medicine, electronics, agriculture, energy, environmental monitoring, communications and manufacturing. The current market for this product line is well in the tri-dollar range and is growing! A product has already been developed in a joint-project on Fiber Breakage Investigation (FBI) studies for Alcatel, a major telecommunication company in the State of Texas and this product has been found to significantly reduce breakage of optical fibers that have to be stripped naked for use in switching devices used in telecommunications. This product is now commercially available through SMT (see page 69 of this catalog).

SMT can assist and support research in method development on nanoparticles for chemical or physical bonding on specific substrates of interest. An example of SMT's current research interest is the creation of SAM of dendrimers for binding on other substrates or biomolecules such as viruses and herpes. Molecular assembly in such fashion has been found to effectively eliminate the infection to human cells caused by the viruses. Another interest is in the creation of SAM for thin layer coating on substrate surfaces

like fused silica, carbon fibers, and zeolites.

Special features:

- Ultra Stable phases for materials engineering
- Versatile applications
- Total Coverage™ bondings
- Opportunities for New products

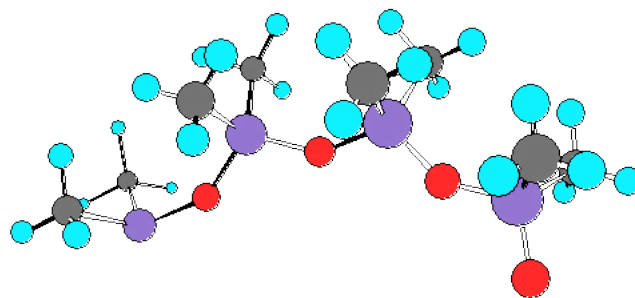

SAM for Thin Layer Coating on Substrate Surfaces

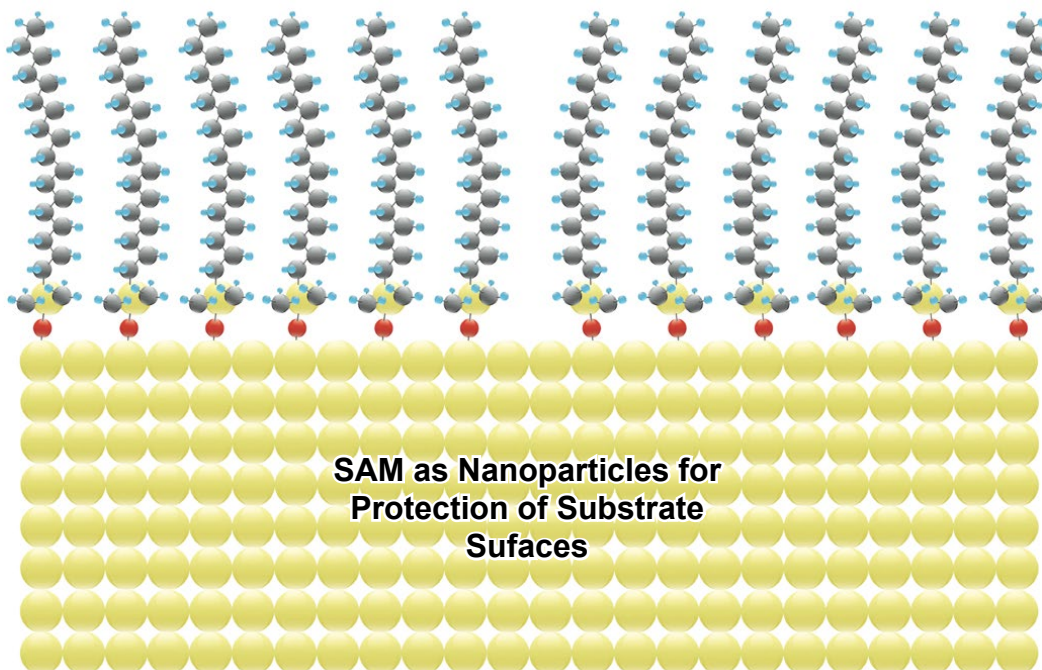

Ordering Information

*Call SMT for price quote on projects and research services

SMT Bulk Packings for Large-Scale Purifications & Other Applications

SMT's specially designed bulk packings are very robust and stable at extreme pH conditions and high temperatures. These packings can be utilized for large-scale purifications of most compounds. Although much of the packing materials highlighted in this catalog are focused around silica substrates, other packing materials that utilize polymer substrates are made available for specific special applications. SMT bulk packing materials are available for large-scale purifications and various applications. These materials are offered to customers, at significant discounts, for process, pilot and production scale applications. SMT also offers assistance in designs of appropriate columns that can be used in applications of these resins. SMT C18 and C8 bulk packings, for example, have been used in various reversed-phase chromatographic modes of separation.

A unique application is in Low and medium pressure separation of plant extracts and pigments in glass cartridges using SMT bulk packings for normal and reversed-phase chromatography.

Other applications include industrial large-scale purification processes. Here, SMT offers polymer-based anion and cation exchange resins that can be used in combination with silica-based reversed phase resins for complete purification process such as in purification of water and regeneration of waste water and other consumable products, where

multiple removal steps are needed in order to achieve the anticipated purification goals. These specialty products, offered by SMT, are actually designed for specific applications per customer's request.

Special features:

- Ultra Stable phases for continuous process, pilot and production-scale purification
- pH stability from 1 to 12 (1-14 for polymer resins)
- Very high bonding coverages
- Provides much higher efficiency

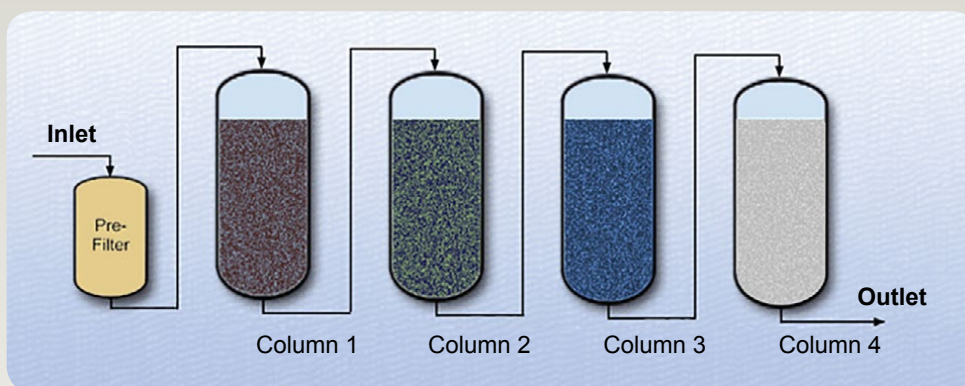

Applications of SMT Bulk:

- Purification of water and regeneration of waste water reservoir
- Low and medium pressure separation of plant extracts

Ordering Information

*Call SMT for price quote on projects and research services

SMT InnovSep™-SPE Cartridges

Solid-Phase Extraction (SPE) is a sample preparation technique that is used to clean up and/or concentrate samples before analysis. Compared to liquid-liquid extraction, SPE is much faster, uses less solvent, and saves money. SPE provides clean extracts and high recoveries. SMT InnovSep™ SPE cartridges have been developed to meet some of the most difficult challenges in sample purification methods: clean extracts and high recoveries.

Generally, SPE products are used in one of two ways. One method involves passing the sample through an SPE packing bed that retains interfering sample components while the analytes pass through unretained. The second, more common, method passes the sample through an SPE packing bed that retains the analytes and, possibly, interfering sample components or other impurities. The interfering components are then washed off of the packing bed before the analytes are eluted. The elution is done with a small solvent volume in order to concentrate the sample, thereby increasing detection limits and making the analysis easier. InnoSep™ SPE packings are offered on the following silica sizes; all cartridges are designed to fit individual customer's needs:

- Small particle (5-10 µm)
- Intermediate Particle (25-40 µm)
- Standard Particle (40-60 µm) and
- Large Particle (125-210 µm)

SMT InnovSep™ SPE Phases are currently available in the following bulk packing materials:

- C18
- C8 Octyl
- C1 Methyl
- C2 Ethyl
- C4 Butyl
- Phenyl
- Silica
- Diol
- Cyano (CN)
- Amino (NH₂)
- Strong Cation Exchange (SCX)
- Weak Cation Exchange (WCX)
- Strong Anion Exchange (SAX)
- Weak Anion Exchange (WAX)
- MetalSep bulk packings

All SMT packing materials can be packed in other SPE columns, flash columns and well plates and are offered in bulk and various quantities.

Empty Reservoirs, Frits and Caps: Empty SPE columns, flash columns and well plates and are offered in various sizes and quantities.

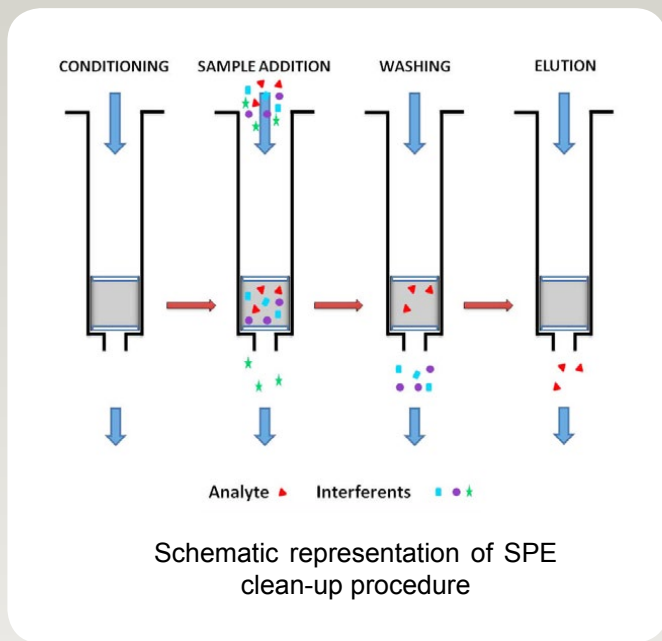
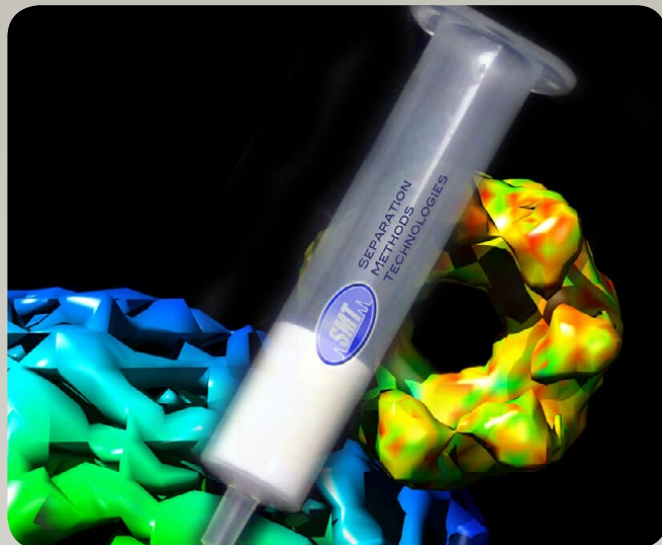

Ordering Information

SMT Bulk-C18 Columns/Packings 35-60 µm, 60Å
 *Product size (mass) Catalog Number
 500 g BOD-35-60/500G
 5 kg BOD-35-60/5KG
 10 kg BOD-35-60/10KG

SMT Bulk-C8 Columns/Packings 35-60 µm, 60Å
 500 g BO-35-60/500G
 5 kg BO-35-60/5KG
 10 kg BO-35-60/10KG

SMT Bulk-C18 Columns/Packings 35-60 µm, 150Å
 *Product size (mass) Catalog Number
 500 g BOD-35-150/500G
 5 kg BOD-35-150/5KG
 10 kg BOD-35-150/10KG

SMT Bulk-C8 Columns/Packings 35-60 µm, 150Å
 500 g BO-35-150/500G
 5 kg BO-35-150/5KG
 10 kg BO-35-150/10KG

*SMT Bulk-C18 and Bulk-C8 packings are available in bulk quantities of 100 g, 250 g, 250g, 500 g, 5 kg, 10 kg.
 For larger quantities call for a price quote

Specialty Products for Materials Engineering

SMT manufactures and designs specialty products for materials engineering. Some of these products have found applications in the treatment of specialty glass surfaces and optical fibers, as illustrated in the following examples.

Fiber Optics

A mixed-ligand mixture that consists of a specially formulated molecular assembly^{1,2} in solution has been developed for bonding on bare optical fibers. The mixed-ligand organizes into a dense, two-dimensionally cross-linked network over the fiber and results in a significant reduction in surface hydrolysis and breakage due to stress. The chemically bonded phase, which provides a film thickness of only about 45-120Å, offers unprecedented protection against chemical and mechanical abuse on exposed fibers¹².

During usage, an optical fiber [Figure 1] is constantly exposed to different harsh environments, such as, water, high humidity, low and high temperatures, chemicals, or a combination of environments. The strength of the fiber is controlled by the growth of cracks that penetrate its molecular structure. The cracks develop from breakage of the tetrahedron network when the fiber is stressed or hydrolysis of the bonds when the fibers are exposed to harsh environments. Even the process of extrusion of the fiber alone can be stressful to the tetrahedron network and it may well be a unique and perhaps an inevitable source of cracks in the fiber.

GC Inlet Liners & Glass Coatings

A mixed-ligand mixture that consists of a specially formulated molecular assembly^{1,2} in solution has been developed for bonding on glass inlet liner used for gas chromatography. The mixed-ligand organizes into a dense, two-dimensionally cross-linked network over the liner and results in a significant reduction in carryover of strongly basic and acidic analytes¹³. The bonded phase is stable to temperature in excess of 350°C

Glass inlet liners [Figure 2] have a direct effect in the analysis results in gas chromatography. When dirty samples are analyzed routinely, replaceable inlet liners (usually made of glass) are often used to minimize the influence of contaminants in subsequent analyses.

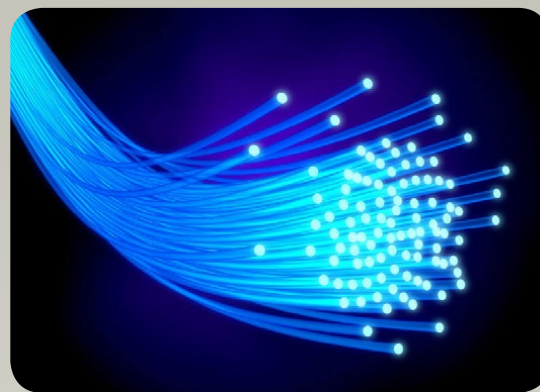

Fig. 1

Exposed Optical Fiber

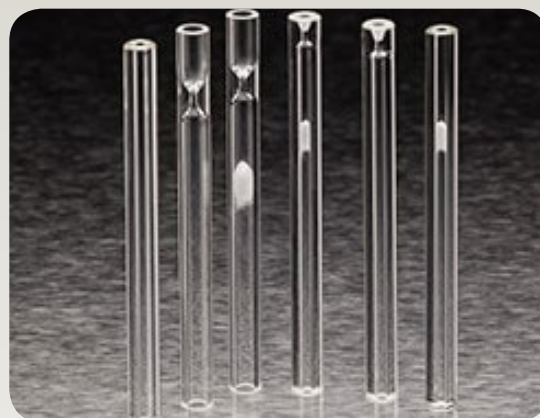
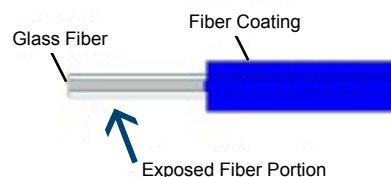
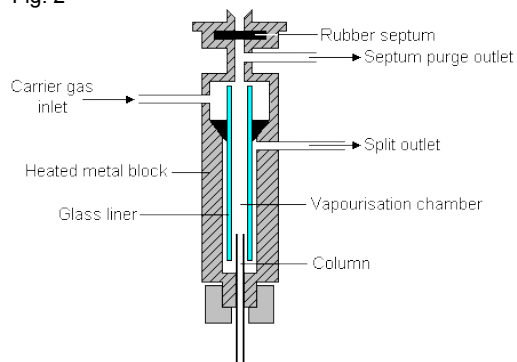

Fig. 2



Ordering Information

*Product size (volume)
500mL
1000mL

Catalog Number
SMT-6 Coatmix/500
SMT-6 Coatmix/1000

*Call SMT for price quote on projects and research services

HPLC Column Selection Guide

Reversed-Phase Columns

SMT SAM-C18 Columns	Equivalent Columns	SAM Elite-C8 Columns	Equivalent Columns
OD-5-100	Luna C18	O-5-100	Luna C8
	YMC ODS-AM		Symmetry C8
	Symmetry C18, Xterra C18		YMC-Pack C8
	Kromasil C18		Xterra C8
	µBondapak C18		Kromasil C8
	Inertsil C18		Inertsil C8
SMT EliteC18	Pursuit XRs-C18	SMT EliteC8	Luna C8
	YMC ODS-AM		Symmetry C8
	Xterra C18		YMC-Pack C8
	Hyperbond C18		Xterra C8
	NucleoSil C18		Kromasil C8
	Inertsil C18		Inertsil C8
ODL-5-100	Jupiter C18	OL-5-100	Nucleodur C8
	Vydac-C18		LiChrospher RP8
	µBondapak C18		YMC-Pack C8
	Synchropac-C18		Xterra C8
	LiChrospher RP18		NucleoSil C8
	Inertsil C18		Inertsil C8
SMT MEB Columns	Ultra	SMT Phenyl Columns	Luna Phenyl, NucleoSil Phenyl
MEB1-5-100	Kromasil C1, Ultra C1	Phen1-5-100	Luna Phenyl
MEB2-5-100	Zorbax SB C3	Phen2-5-100	Cosmosil NAP
MEB4-5-100	NucleoSil C4, Ultra C4		

Normal Phase Columns

SMT NH2 Columns	Luna NH2	SMT CN-Columns	Luna CN, Ultra Cyano
AP-5-100	Kromasil NH2	CP-5-100	Zorbax SB CN
	YMC-Pack-NH2, Nucleosil NH2		Nucleodur CN
SMT Silica Columns	Kromasil Si	SMT-Diol Columns	Lichrosorb Diol
S-5-100	Spherisorb	Diol1-5-100	Spherex Diol
	Luna Silica	Diol2-5-100	YMC-Pack Diol
	NucleoSil Si		NucleoSil Diol

Ion-Exchange & Specialty Columns

SMT SAX Columns	Hypersil SAX	SMT SCX Columns	Vydac SCX
SAX-5-100	Vydac SAX	SCX-5-100	PureGel SCX
	PureGel SAX		Capcell Pak SCX
SMT WAX Columns	Vydac WAX	SMT WCX Columns	PartiSphere WCX
WAX-5-100	BioSep DEAE	WCX-5-100	Gammabond WCX
SMT DEAE Columns	BioSep DEAE	SMT ODIQ-Columns	Aqua C18, Ultra Aqueous-C18
SMT C6 or H-Columns	Luna C5	SMT Urea-Columns	
SMT PAH Columns	Luna C18, EnviroSep PAH	SMT C6F5 Columns	Phenomenex-Curosil
PAH1	Vydac PAH, Pinnacle II PAH	C6F5	Supelco Sil LC-F
SMT ChiralSep1 columns	Lux, Chirex, Chiralpak AD, AD-H, IA	SMTgel	
SMT ChiralSep2 Columns	Chiralpak IC	SMT CIB Columns	

References Cited

1. Mary J. Wirth and Hafeez O. Fatunmbi, "Products Having Multiple substituted Polysiloxane Monolayer" U.S. Patent No. 5,599,625, 1997.
2. Mary J. Wirth and Hafeez O. Fatunmbi, "Products Having Multiple-substituted Polysiloxane Monolayer" U.S. Patent No. 5,716,705, 1998.
3. Mary J. Wirth, R.W. Peter Fairbank, and Hafeez O. Fatunmbi, "Mixed Self-Assembled Monolayers in Chemical Separations," *Science*, 44, 275, 1997.
4. Hafeez O. Fatunmbi, Martha D. Bruch, and Mary J. Wirth " ^{29}Si and ^{13}C NMR Characterization of Mixed Horizontally Polymerized Monolayers on Silica Gel" *Anal. Chem.* 65, 2048, 1993.
5. Ming Huang, Eva Dubrovckova, Milos Novotny, Hafeez O. Fatunmbi and Mary J. Wirth, "Self-Assembled Alkylsilane Monolayers for the Preparation of Stable and Efficient Coatings in Capillary Electrophoresis" *J. Microcolumn Sep.* 6, 571, 1994.
6. Mary J. Wirth and Hafeez O. Fatunmbi, "Horizontal Polymerization of Mixed Trifunctional Silanes on Silica: A Potential Chromatographic Stationary Phase" *Anal. Chem.* 64, 2783, 1992 .
7. Mary J. Wirth and Hafeez O. Fatunmbi, "Horizontal Polymerization of Mixed Trifunctional Silanes on Silica: 2 Application to Chromatographic Silica Gel" *Anal. Chem.* 65, 8a22, 1993.
8. Mary J. Wirth and Hafeez O. Fatunmbi, "Self-Assembly Monolayers in Separations" *LC.GC.* 12, 222, 1994.
9. Ian S. Zagon, W. Jeffery Hurst, and Patricia J. McLaughlin, *Life Sci.* 61, 1261, 1997.
10. R. W. Peter Fairbank, Yang Xiang, and Mary J. Wirth, "Use of Methyl Spacers in a Mixed Horizontally Polymerized Stationary Phase" *Anal. Chem.* 67, 3879, 1995.
11. Samuel O. Akapo and Hafeez O. Fatunmbi, "The Performance of Mixed Horizontally Polymerized Phases Versus Conventional C18 Silica Columns for Reversed-Phase HPLC" *LC.GC.* 17, 334, 1999.
12. Mary J. Wirth, "Spectroscopic Probing of Reversed-Phase Chromatographic retention" *LC.GC.* 12, 656, 1994.
13. Mathias Pursch, Lane Sander, and Klaus Albert, "chain Order and Mobility of High-Density C18 Phases by Solid-State NMR Spectroscopy and Liquid Chromatography" *Anal. Chem.* 68, 4107, 1996.
14. Li Li, Peter W. Carr and John F. Evans, "Studies of Retention and Stability of a Horizontally Polymerized Bonded Phase for Reversed-phase Liquid Chromatography" *Journal of Chromatogr. A* 868, 153, 2000.
15. Martha D. Bruch and Hafeez O. Fatunmbi, "NMR Analysis of Silica Gel Surfaces Modified with Mixed, Amine-Containing Ligands" *J. Chromatogr. A*, 1021, 61, 2003.
16. Hafeez O. Fatunmbi and Martha D. Bruch, "Characterization of the Structural Morphology of Chemically Modified Silica Prepared by Surface Polymerization of a Mixture of Long and Short Alkyl Chains Using ^{13}C and ^{29}Si NMR Spectroscopy" *Langmuir* 29, 4974, 2013.

SMT Application Notes: HPLC SEPARATION GUIDE and OTHER APPLICATIONS

1. Standard C18 column in high throughput LC-MS applications
2. Separation of Isoflavones in Soy App. Note No. 102-001 Jan. 2002.
3. Isolation of Protein Molecules with SMT C18 App. Note No. 1101-001 Nov. 2001.
4. Isolation of p-Amino Benzoic Acid (PABA) derivatives with SMT-C4 Column App. Note No. 1101-001 Nov. 2001.
5. Drug Screening with SMT-QuickSep Columns App. Note No. 0900-001 Mar. 2000.
6. Process Scale Purification with SMT Bulk C18 Packings App. Note No. 0300-001 Mar. 2000.
7. Separation of Steroids with SMT-C18 App Note No. 0599-001 May. 1999.
8. Separation of Closely Related Drug Molecules with SMT-C18 App. Note No. 0199-001 Jan. 1999.
9. Separation of Closely Related Phenols SMT-C18 App. Note No. 0698-001 Jun. 1998
10. Analysis of Pesticides with SMT-C18 columns App. Note No. 0498-001 Apr. 1998.
11. Separation of Organic Acids with SMT-C8 App. Note No. 0298-001 Feb. 1998.
12. Separation of Closely Related Tetracyclines with SMT C8 and C18 columns App. Note No. 1197-001 Nov. 1997.
13. Low Detectability of Cocaine and Nicotine with SMT-QuickSep Column App. Note No. 0397-001 Mar. 1997.
14. Analysis of Fat-Soluble Vitamins App. Note No. 0297-001 Feb. 1997.
15. Analysis of Nitroaromatic Explosives App. Note No. 0197-001 Jan. 1997.
16. Identification of Mycobacterium Intracellulare by HPLC and Computer Driven Pattern Recognition System App. Note No. 0896-003 Aug. 1996.
17. Analysis of the Gentamicin Complex App. Note No. 0796-003 Jul. 1996.
18. Analysis of Antibacterial Residues Cow Milk App. Note No. 0496-002 Apr. 1996.
19. Analysis of Flavonoids in Green Tea App. Note No. 0496-001 Apr. 1996.
20. Analysis of Priority Pollutant: Polycyclic Aromatic Hydrocarbons App. Note No. 0396-001 Mar. 1996.
21. Analysis of Active Ingredients in a Sun Screen App. Note No. 0196-001 Jan. 1996.
22. Separation of Nucleotides App. Note No. 1195-003 Nov. 1995.
23. Fiber breakage elimination with ultra-stable molecular assembly vol 1 1999.



UNITED STATES

Separation Methods Technologies, Inc.
Corporate Headquarter
31 Blue Hen Drive
Newark, DE 10713
Tel: 302-368-0610
Fax: 302-368-0282
sales@separationmethods.com
Web Site: www.separationmethods.com

Analtech, Inc. (i-Chromatography)
75 Blue Hen Drive
Newark, DE 19713
Tel 1: 800-441-7540
Tel 2: 302-737-6960
Fax: 302-737-7115
cs@analtech.com

Fisher Scientific
Pittsburgh, PA
Tel: 800-955-9999
cs.webemail@fishersci.com

NuWater
125 Mason Circle, Unit A
Concord, CA 94520
Tel: 888-835-9511
Fax: 888-847-5029
info@nuwaterusa.com

VWR Scientific Products
Bridgeport, NJ 08014
Tel: 800-879-7795
technicalproductSupportNA@vwr.com

CANADA

Rose Scientific Ltd
5750 Vanden Abeele
St. Laurent, Montreal
Canada H4S 1R9
Tel: 514-334-1892
Fax: 514-334-1898
sales@rosesci.com

AUSTRIA

ICT Chemietechnik GmbH
Mariahilfer Str. 1B
A-1060 Wien, Vienna, Austria
Tel: 43-1-585-7700
Fax: 43-585-7701
office@ict-inter.net

CHINA

Lanbo Instrument Tianjin Co., Ltd.
C-12A, Shuixie Garden,
Shuishang North Road
Tianjin 300074 P.R. China
Tel: 022-23592982
Fax: 022-23592987
tianjinlanbo@vip.163.com

FRANCE

Interchim
213 Avenue Kennedy, BP 1140
Montlucon Cedex 03103, France
Tel: 33-0470-0388-55
Fax: 33-0470-0382-80
interchim@interchim.com

GERMANY

(ALGERIA, TUNISIA & MOROCCO)
Polypharma Technologies & Sciences
GmbH
Grosse Reichenstrasse 27
D-20457 Hamburg, Germany
Tel: 49 40-374 80 30
Fax: 49 40-374 80 320
info@polypharma.de

INDIA

S.V. Scientific
2nd Floor, Serpentine Road
Kumara Park West
Bangalore 560 020, India
Tel: 91 80-23567255
Fax: 91 80-23446548
info@svscientific.in

ISRAEL

Lab Experts
P.O.B. 3383
Bat Yam 59134 Israel
Tel: 972-3-657-3785
Fax: 972-3-657-3785
alexander@lab-experts.com

NIGERIA

Specpharm Limited
11 Eburn Close, Abule Ijesa
Lagos, Nigeria
Tel: 80-3-333-9192

PAKISTAN

MIH Enterprises
Flat 14, 3rd floor
Qureshi Manzil, Akbar Road
Back Side Frere Mkt,
Karachi, Pakistan
Tel: 92-21-35436034
mihfaisal@gmail.com

PakFil Technologies
E-380/3, Block B
Nishat Colony Lahore Cantt.
54810 Lahore, Pakistan
Tel: 92-42-35692123
Fax: 92-42-37224051
fj@pakfiltechnologies.com

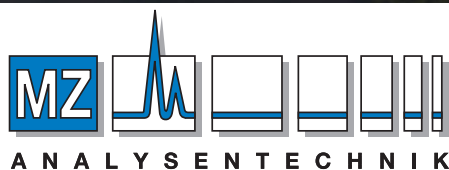

AUTHORIZED DISTRIBUTOR

MZ-Analysentechnik GmbH, Barcelona-Allee 17 • D-55129 Mainz
Tel +49 6131 880 96-0, Fax +49 6131 880 96-20
e-mail: info@mz-at.de, www.mz-at.de