

HPLC, LC/MS Column

InertSustain™

Inertsil continues to evolve to InertSustain...



Contents

An Outline of InertSustain	2 ~ 3
InertSustain C18	4 ~ 7
InertSustain C8	8
InertSustain Phenyl	9
InertSustain NH2	10
Column Selectivity	11
Applications.....	11 ~ 13
Benefits	14 ~ 15
Ordering Guide	16 ~ 23

Inertness and Durability combined in a new HPLC column

InertSustain™

Generally, silica based columns are mechanically stable and provide high efficiencies, however, they cannot be used under alkaline conditions and their residual silanol groups tend to adsorb organic bases.

InertSustain employs a radically new type of silica, in which the surface of the silica is uniquely modified, enabling precise control of the silica properties. InertSustain inherits the advantages of all the current Inertsil HPLC columns (e.g., extremely low operating back pressure, superior inertness to typically any analytes, high efficiency and compatibility with a wide range of solvents), but now can be used for wide pH analysis with consistent performance from column to column and lot to lot.

1st Stage [Synthesis of Evolved Surface Silica]



InertSustain features Unmatched Inertness and Durability

Radically New Silica Gel

It is not possible to end-cap 100 % of residual silanols using traditional chemical modification procedures.

GL Sciences studied the possibility of developing a radically new type of silica, a silica that would provide both high inertness (base deactivation) and durability at a wide range of pH.

1st Stage [Synthesis of "Evolved Surface Silica"]

As the adsorption sites and silanol distribution are strictly controlled from the synthesis procedure of the Evolved Surface Silica, InertSustain delivers unmatched inertness to virtually any type of analyte with high durability to acidic, basic mobile phase conditions.

2nd Stage [Chemical Bonding of ODS group]

The introduction of Evolved Surface Silica and our cutting-edge chemical bonding technology make InertSustain compatible with 100 % aqueous mobile phases, while maintaining strong non-polar retentivity.

3rd Stage [Complete End-capping]

GL Sciences' complete end-capping technology allows InertSustain to provide high efficiency and superior peak shape even to those well-known strong adsorptive analytes.

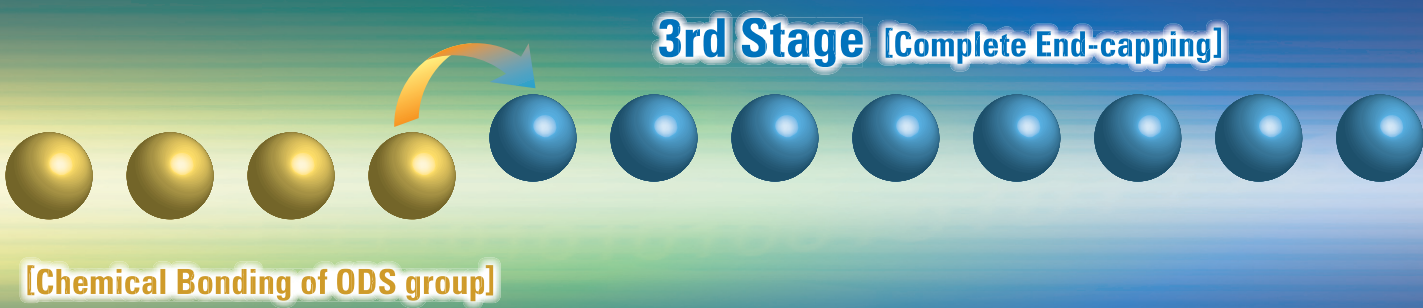
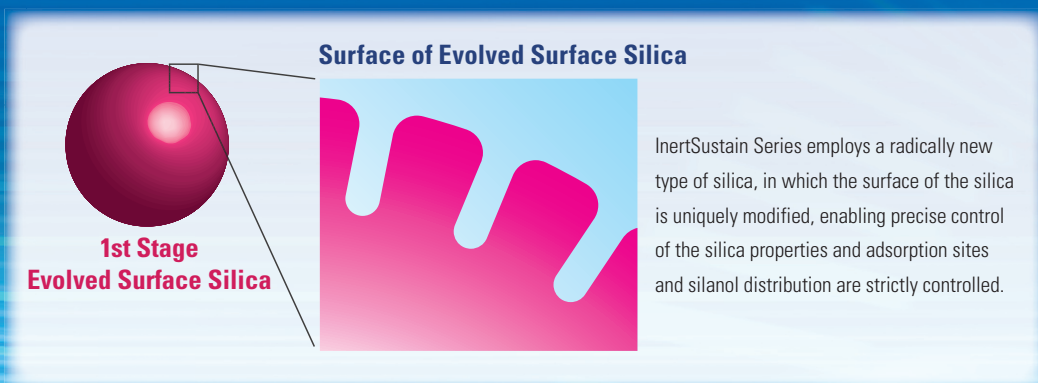

InertSustain™ Series

Developing a new method is a time-consuming operation. On top of this selecting an HPLC column plays a major role to achieve the desired separation for your critical analysis.

The InertSustain series are offered with C18, C8, Phenyl and Aminopropyl phases, which cover an extended range of selectivity with extremely inert packing materials to answer your difficult method development.

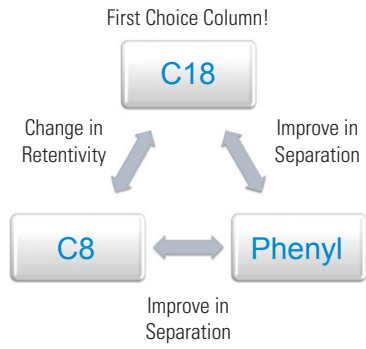

Physical Properties

Column Name	Bonded Phase	Particle Size	Surface Area (m ² /g)	Pore Size (nm)	Carbon Loading (%)	End-capping	USP Code
InertSustain C18	Octadecyl Groups	2 μm, 3 μm, 5 μm	350	10	14	Complete	L1
InertSustain C8	Octyl Groups	3 μm, 5 μm	350	10	8	Complete	L7
InertSustain Phenyl	Phenyl Groups	3 μm, 5 μm	350	10	10	No	L11
InertSustain NH2	Aminopropyl Groups	3 μm, 5 μm	350	10	7	No	L8

InertSustain™ C18

Tailing of peaks or adsorption of peaks can be experienced when a column has residual adsorption sites. Such phenomenon would not be observed on InertSustain as the silanols are completely end-capped, having a neutral silica surface.

Physical Properties

Silica	: Newly Developed Silica Gel	Bonded Phase	: Octadecyl Groups
Particle Size	: 2 μm , 3 μm , 5 μm	End-capping	: Complete
Surface Area	: 350 m^2/g	Carbon Loading	: 14 %
Pore Size	: 100 \AA (10 nm)	USP Code	: L1
Pore Volume	: 0.85 mL/g	pH Range	: 1 ~ 10

- High Inertness
- Long Column Lifetime
- Reliable Reproducibility
- Extremely Low Operating Back Pressure
- pH Range from 1 ~ 10

Experience the InertSustain! (Inertness and Sustainability)

Highly end-capped ODS column such as InertSustain C18 offers an opportunity to flush out contaminants from the column surface easily using an organic solvent. Coffee melanoidins are brown heterogeneous polymers contained in coffee. Its components are not clarified yet, but it is considered to contain several ionic compounds, which a poorly end-capped column will adsorb those ionic compounds leading to short column lifetime. As for ODS column, which is commonly used for HPLC and LC/MS/MS, its inertness has an influence not only on peak shape but also detection sensitivity and durability. It is highly recommended to use highly end-capped column which provides good peak shape for both basic and acidic compounds such as InertSustain C18.

The packing material was visually confirmed by removing the column joint.

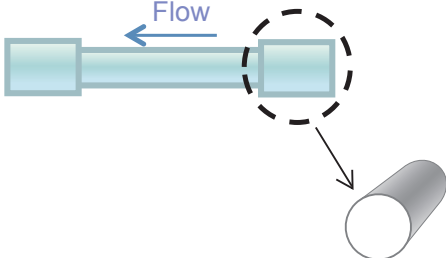

Flow

Before Experiment

Injection of Coffee

After loading Coffee

After washing the column with CH_3CN 100%
※ 10 minute washing

Ionic contaminants were hard to be washed out from the column

Brand A

InertSustain C18

Still Contaminated...

Clean!

Detailed description: This diagram compares the cleaning performance of two HPLC columns, Brand A and InertSustain C18. The process starts with a 'Before Experiment' state where both columns contain a white packing material. After 'Injection of Coffee', both columns show a brown residue. Following '10 minute washing with 100% CH3CN', the InertSustain C18 column is shown as 'Clean!' with a white residue-free surface, while the Brand A column is 'Still Contaminated...' with a brown residue remaining. A note states 'Ionic contaminants were hard to be washed out from the column' pointing to the Brand A column.

Quality and Performance of InertSustain™

To maintain precise product reproducibility, strict chromatographic tests for inertness, durability, theoretical plates and reproducibility of retention time are employed.

Basic Compound

InertSustain C18

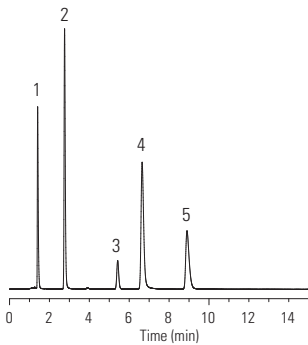

X SELECT CSH C18

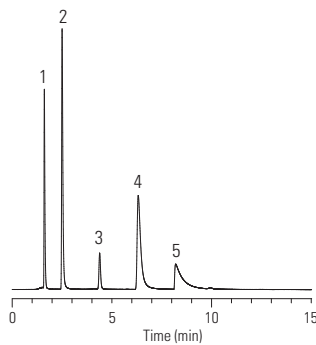

ZORBAX Eclipse Plus C18

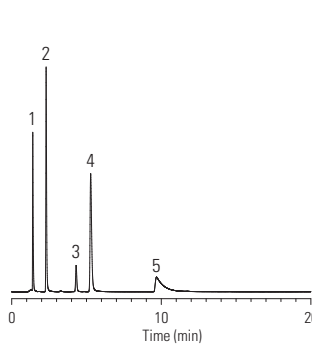

Conditions

Column Size : 3 μ m, 150 \times 2.1 mm I. D.
 Eluent : A) CH₃CN
 B) 25 mM K₂HPO₄ (pH 7.0, KH₂PO₄)
 A / B = 30 / 70, v / v
 Flow Rate : 0.2 mL / min
 Col. Temp. : 40 °C
 Detection : UV 230 nm
 Sample : 1. Uracil
 2. Pyridine
 3. Phenol
 4. Berberine chloride
 5. Dextromethorphan

Acidic Compound

InertSustain C18

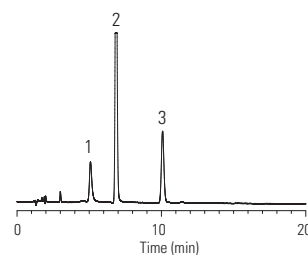

X SELECT CSH C18

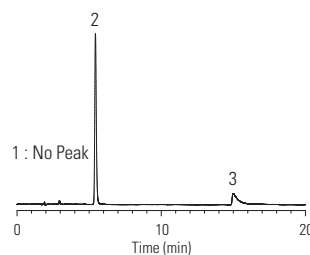

ZORBAX Eclipse Plus C18

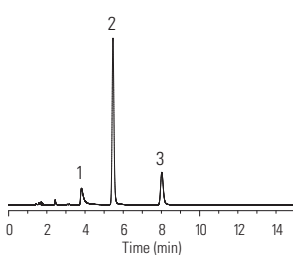

Conditions

Column Size : 3 μ m, 150 \times 2.1 mm I. D.
 Eluent : A) CH₃CN
 B) 0.1 % H₃PO₄
 A / B = 25 / 75, v / v
 Flow Rate : 0.2 mL / min
 Col. Temp. : 40 °C
 Detection : UV 254 nm
 Sample : 1. Brilliant Blue FCF
 2. Phenol
 3. Salicylic acid

Chelating Compound

InertSustain C18

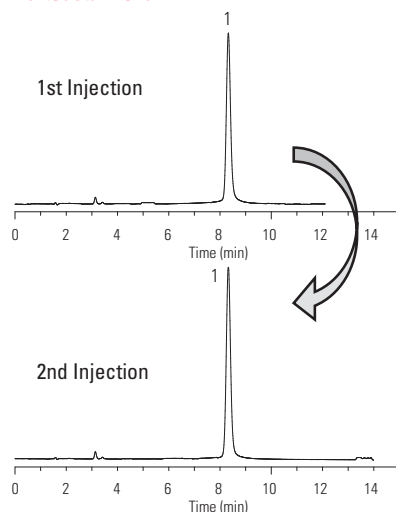

X SELECT CSH

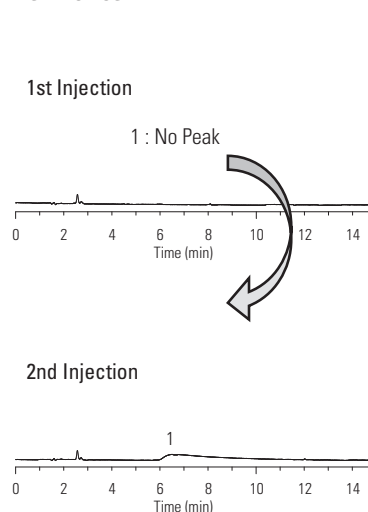

Conditions

Column Size : 5 μ m, 150 \times 4.6 mm I. D.
 Eluent : A) CH₃CN
 B) 0.1 % H₃PO₄
 A / B = 40 / 60, v / v
 Flow Rate : 1.0 mL / min
 Col. Temp. : 40 °C
 Detection : UV 254 nm
 Sample : 1. Hinokitiol

InertSustain™ C18

Wide pH compatibility with Long Column Lifetime

As shown in the experiment below, due to the introduction of Evolved Surface Silica, InertSustain C18 maintained high efficiency and peak shape for 300 hours while other "wide pH" column brands failed.

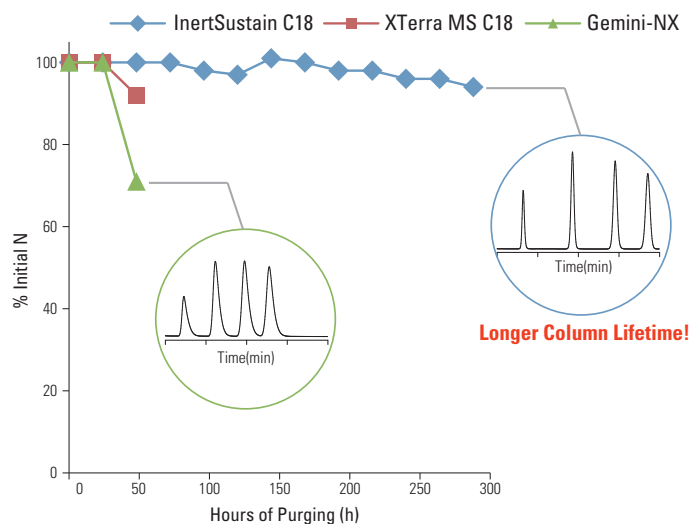

Purging Conditions

Column Size : 5 μ m, 150 \times 4.6 mm I.D.
 Eluent : A) 50 mM Triethylamine (pH10.0)
 B) CH₃OH
 A / B = 70 / 30, v / v
 Flow Rate : 1.0 mL / min
 Col. Temp. : 50 °C

Analytical Conditions

Eluent : A) CH₃CN
 B) H₂O
 A / B = 65 / 35, v / v
 Flow Rate : 1.0 mL / min
 Col. Temp. : 40 °C
 Detection : UV 254 nm
 Sample : Naphthalene

Extremely Low Operating Back Pressure

Due to the introduction of Evolved Surface Silica, InertSustain C18 offers a significantly lower operating back pressure without sacrificing efficiency. As shown below, InertSustain C18 produces the lowest back pressure than other brands columns in the industry.

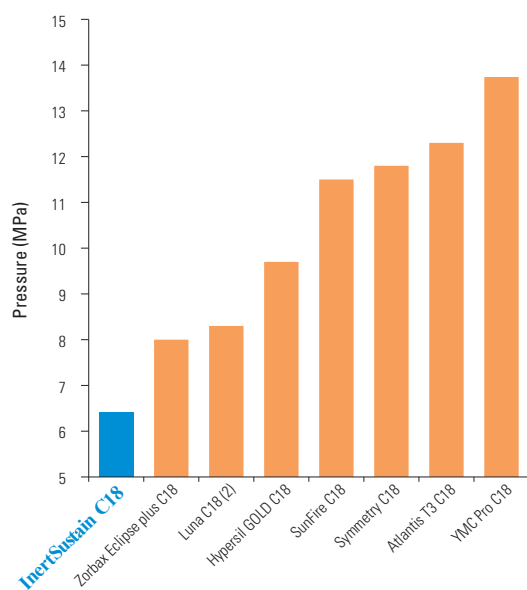

Conditions

Column Size : 5 μ m, 250 \times 4.6 mm I.D.
 Eluent : A) CH₃OH
 B) H₂O
 A / B = 80 / 20, v / v
 Flow Rate : 1.0 mL / min
 Col. Temp. : 40 °C

Reliable Reproducibility, Performance and Quality

Rigorous quality control of physical properties and strict chromatographic tests for inertness and selectivity, contribute to the production of InertSustain C18 with an outstanding reproducibility and long column lifetime.

Strong Basic Compound Test

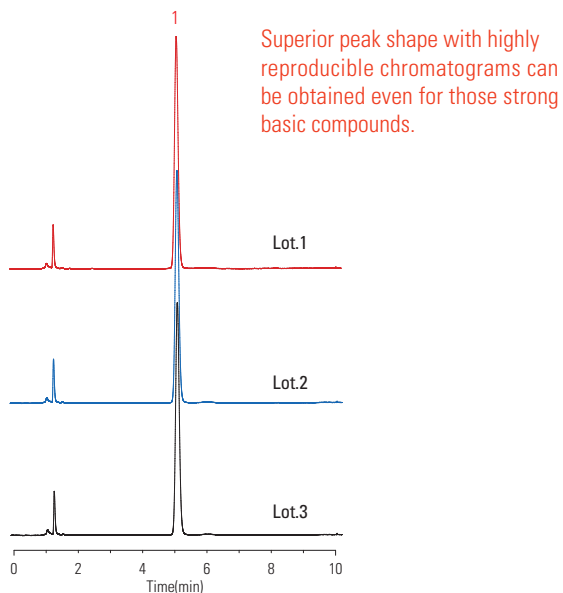

Conditions

Column Size : 5 μ m, 250 \times 4.6 mm I.D.
 Eluent : A) CH₃CN
 B) 25 mM phosphate buffer (pH 7.0)
 A / B = 40 / 60, v / v
 Flow Rate : 1.0 mL / min
 Col. Temp. : 40 °C
 Detection : UV 220 nm
 Sample : 1. Dextromethorphan

Same Retention Behavior between Various Particle Sizes

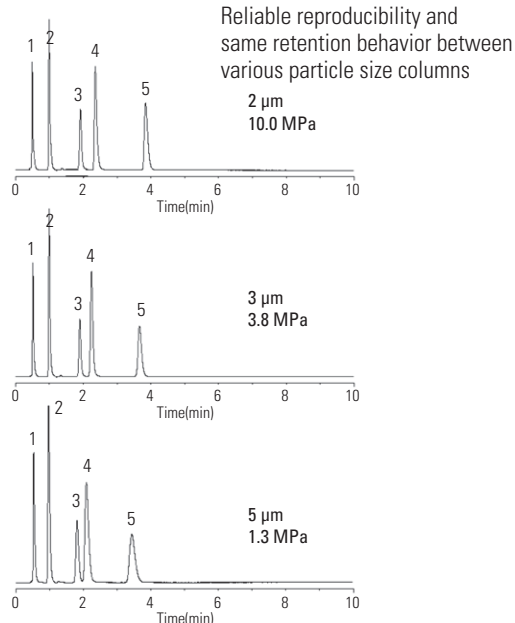

Conditions

Column Size : 50 \times 2.1 mm I.D.
 Eluent : A) CH₃OH
 B) 25 mM phosphate buffer (pH 7.0)
 A / B = 30 / 70, v / v
 Flow Rate : 0.2 mL / min
 Col. Temp. : 40 °C
 Detection : UV 230 nm
 Sample : 1. Uracil
 2. Pyridine
 3. Phenol
 4. Berberine chloride
 5. Dextromethorphan

Strong Acidic Compound Test

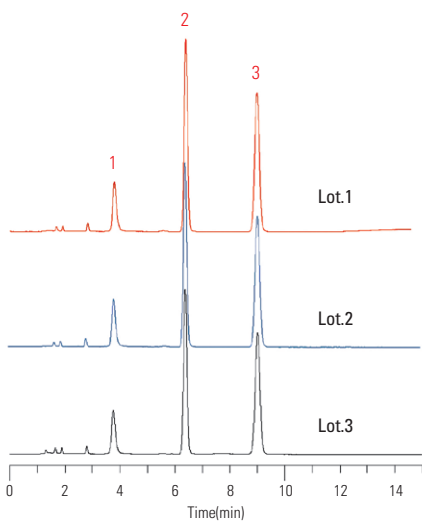

Conditions

Column Size : 5 μ m, 150 \times 4.6 mm I.D.
 Eluent : A) CH₃CN B) 0.1 % H₃PO₄
 A / B = 25 / 75, v / v
 Flow Rate : 1.0 mL / min
 Col. Temp. : 40 °C
 Detection : UV 254 nm
 Sample : 1. Brilliant Blue FCF
 2. Phenol
 3. Salicylic acid

Strong Chelating Compound Test

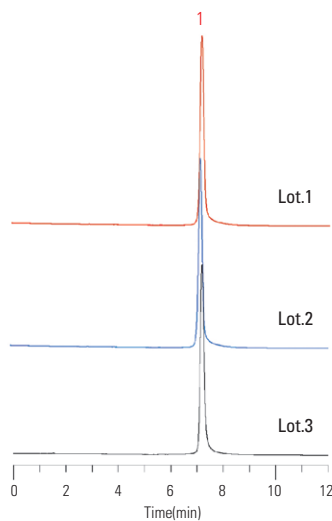

Conditions

Column Size : 5 μ m, 150 \times 4.6 mm I.D.
 Eluent : A) CH₃CN B) 0.1 % H₃PO₄
 A / B = 40 / 60, v / v
 Flow Rate : 1.0 mL / min
 Col. Temp. : 40 °C
 Detection : UV 254 nm
 Sample : 1. Hinokitiol

InertSustain™ C8

InertSustain C8 is an octyl group (C8) bonded column delivering the same extreme inertness to any type of compounds just like InertSustain C18, which enables rapid analysis of highly hydrophobic compounds delivering symmetric peaks at a wide range of pH.

Physical Properties

Silica	: Newly Developed Silica Gel	Bonded Phase	: Octyl Groups
Particle Size	: 3 μm, 5 μm	End-capping	: Complete
Surface Area	: 350 m ² /g	Carbon Loading	: 8 %
Pore Size	: 100 Å (10 nm)	USP Code	: L7
Pore Volume	: 0.85 mL/g	pH Range	: 1 ~ 10

InertSustain C18

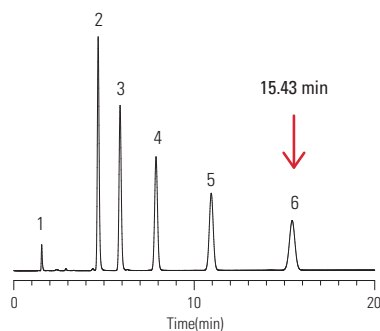

InertSustain C8

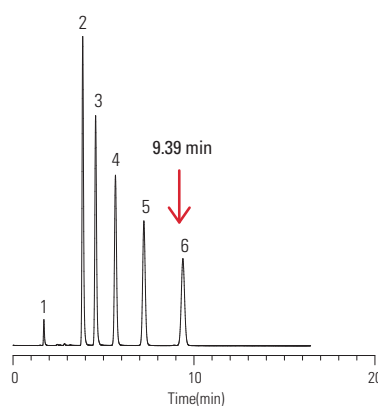

Conditions

Column Size : 5 μm, 150 × 4.6 mm I.D.
 Eluent : A) CH₃OH
 : B) H₂O
 : A / B = 80 / 20, v / v
 Flow Rate : 1.0 mL / min
 Col. Temp. : 40 °C
 Detection : UV 254 nm

Sample :

1. Uracil
2. Toluene
3. Ethylbenzene
4. Propylbenzene
5. *n*-Butylbenzene
6. *n*-Amylbenzene

Analysis of Lincomycin under a condition based on the 16th Edition Japanese Pharmacopeia

Stable Dissociation and Reproducible Retention

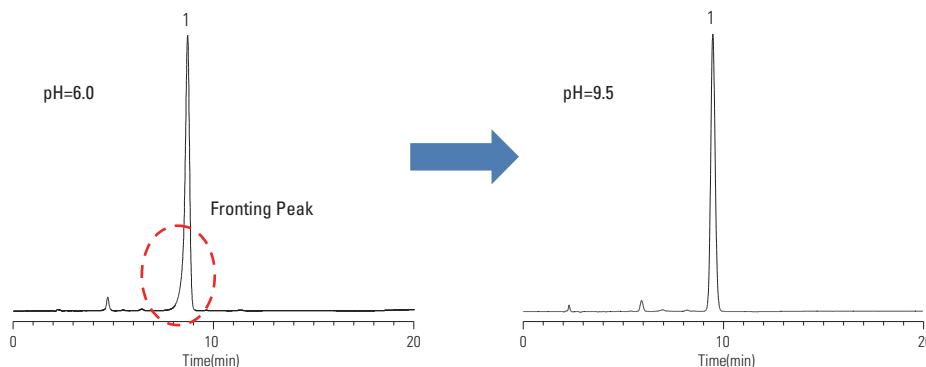

Conditions

Column : InertSustain C8 (5 μm, 250 × 4.6 mm I.D.)
 Eluent : A) CH₃CN B) CH₃OH C) H₃PO₄ in H₂O (pH 6.0, Ammonia solution in H₂O)
 : A / B / C = 150 / 150 / 780, v / v / v or
 : A) CH₃CN B) CH₃OH C) 0.1 % Ammonia solution in H₂O (pH 9.5, H₃PO₄)
 : A / B / C = 225 / 225 / 550, v / v
 Flow Rate : 1.2 mL / min
 Col. Temp. : 46 °C (pH 6.0) or 25 °C (pH 9.5)
 Detection : UV 210 nm
 Sample : 1. Lincomycin

InertSustain™ Phenyl

InertSustain Phenyl delivers an extremely unique reverse phase characteristics that are critical to resolving compounds that could not be separated on a C18 or C8 phase. InertSustain Phenyl provides not only pi-pi interactions, but also hydrogen bonding secondary interactions, which results in retaining polar compounds at the same time. In addition, InertSustain Phenyl is compatible with the analysis of structural isomers due to its high stereo-selectivity.

Physical Properties

Silica	: Newly Developed Silica Gel	Bonded Phase	: Phenyl Groups
Particle Size	: 3 μm, 5 μm	End-capping	: None
Surface Area	: 350 m ² /g	Carbon Loading	: 10 %
Pore Size	: 100 Å (10 nm)	USP Code	: L11
Pore Volume	: 0.85 mL/g	pH Range	: 2 ~ 7.5

InertSustain C18

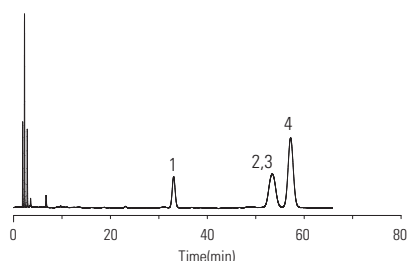

InertSustain Phenyl

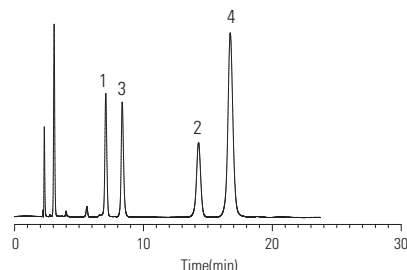

Other Brands Phenyl Column

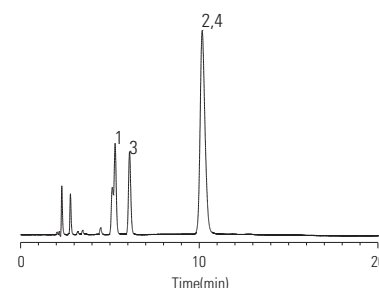

Conditions

Column Size : 5 μm, 150 × 4.6 mm I.D.
 Eluent : A) CH₃OH
 B) H₂O
 A / B = 70 / 30, v / v
 Flow Rate : 0.8 mL / min
 Col. Temp. : 40 °C
 Detection : UV 254 nm

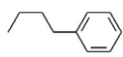

1. Butylbenzene

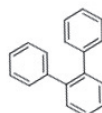

2. *o*-Terphenyl
(Non-planar structure)

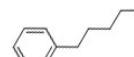

3. Amylbenzene

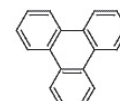

4. Triphenylene
(Planar structure)

Analysis of Structural Isomers

Efficient for the separation of structural isomers having the same mass which cannot be differentiated by LC/MS

InertSustain Phenyl

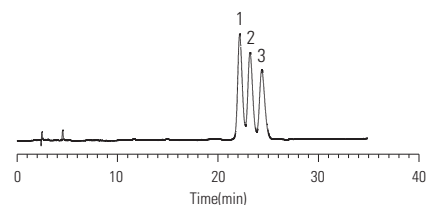

Ascentis Phenyl

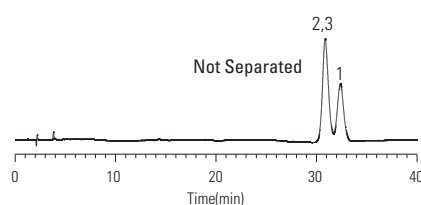

XBridge Phenyl

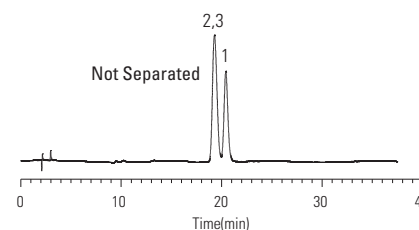

Conditions

Column Size : 5 μm, 150 × 4.6 mm I.D.
 Eluent : A) CH₃OH
 B) H₂O
 A / B = 20 / 80, v / v
 Col. Temp. : 40 °C
 Flow Rate : 0.8 mL / min
 Detection : UV 254 nm

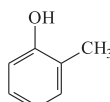

1. *o*-Cresol

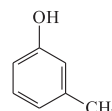

2. *m*-Cresol

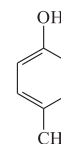

3. *p*-Cresol

InertSustain™NH2

InertSustain NH2 shows far superior stability compared to those commercially available aminopropyl columns on the market as our newly developed "Evolved Surface Silica" is chemically bonded with aminopropyl group. Generally, aminopropyl columns are used for applications that are hard to be separated in a reversed phase mode (e.g., simultaneous analysis of sugars or vitamin E), however, the shift in retention time has been an issue for a long time. InertSustain NH2 delivers highly reliable reproducibility and stability with accurate qualitative and quantitative results.

Physical Properties

Silica	: Newly Developed Silica Gel	Bonded Phase	: Aminopropyl Groups
Particle Size	: 3 μm, 5 μm	End-capping	: None
Surface Area	: 350 m ² /g	Carbon Loading	: 7 %
Pore Size	: 100 Å (10 nm)	USP Code	: L8
Pore Volume	: 0.85 mL/g	pH Range	: 2 ~ 7.5

Comparison of Stability between various Aminopropyl columns

Commercially available amino columns were compared to confirm their stability by checking the retention time of Maltose. As shown in the experiment below, InertSustain NH2 maintained high stability.

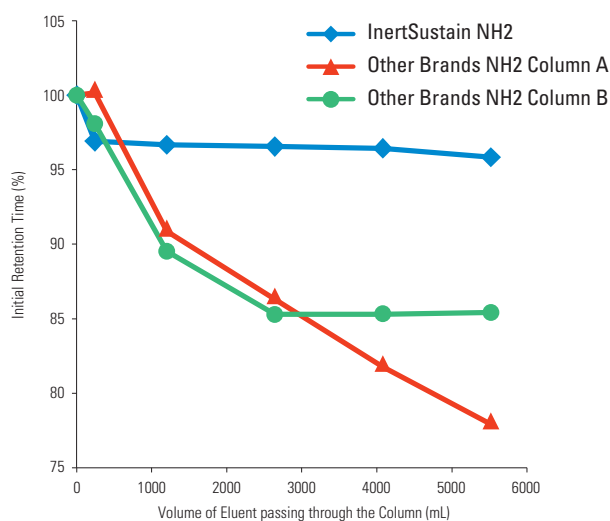

Conditions

Column Size : 5 μm, 250 × 4.6 mm I.D. Sample : 1. Maltose
 Eluent : A) CH₃CN
 B) H₂O
 A / B = 75 / 25, v / v
 Flow Rate : 1.0 mL / min
 Col. Temp. : 40 °C
 Detection : RI

Reliable Reproducibility, Performance and Quality from Lot to Lot

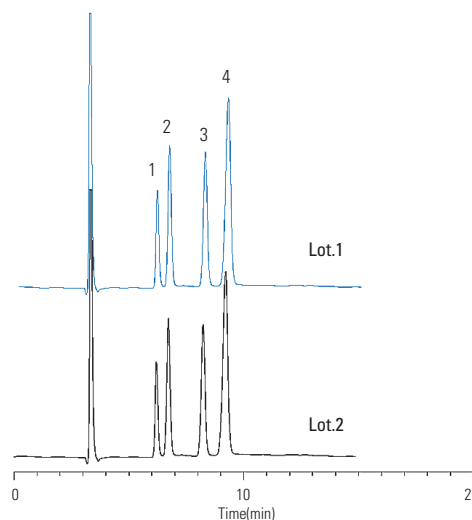

Conditions

Column Size : 5 μm, 250 × 4.6 mm I.D. Sample : 1. Fructose
 2. Glucose
 3. Sucrose
 4. Maltose
 Eluent : A) CH₃CN
 B) H₂O
 A / B = 85 / 15, v / v
 Flow Rate : 1.0 mL / min
 Col. Temp. : 40 °C
 Detection : RI

Analysis of Malto Oligosugars

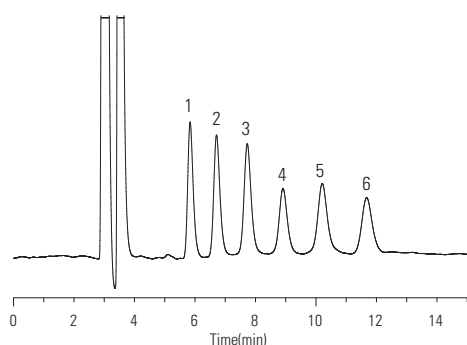

Conditions

Column : InertSustain NH2 (5 μm, 250 × 4.6 mm I.D.) Sample : 1. Maltose
 2. Maltotriose
 3. Maltotetraose
 4. Maltopentaose
 5. Maltohexaose
 6. Maltoheptaose
 Eluent : A) CH₃CN
 B) H₂O
 A / B = 65 / 35, v / v
 Flow Rate : 1.0 mL / min
 Col. Temp. : 30
 Detection : RI

Comparison of Selectivity between various GL Sciences' Columns

Selecting the most suitable column can be very difficult. As a first choice column, we highly recommend to start with InertSustain C18 which offers the flexibility to work under any mobile phase and pH conditions with high inertness and durability. Other variety of phases are available to change the selectivity or retentivity of your critical samples.

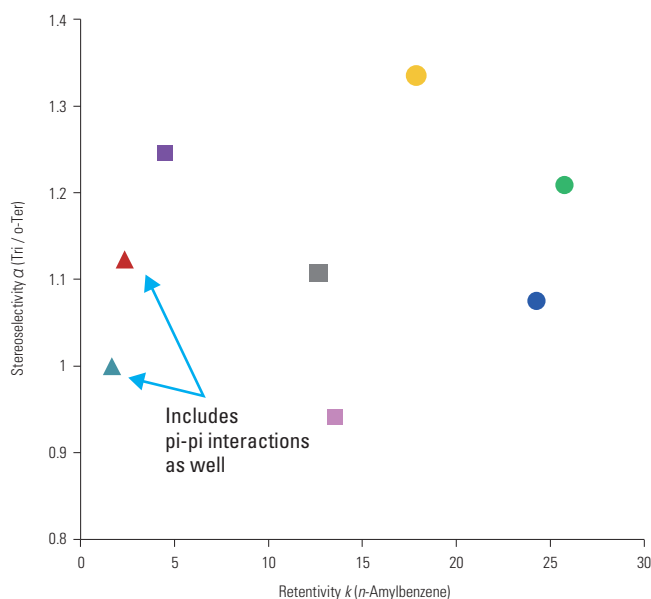

- InertSustain C18
- Inertsil C8-3
- Inertsil C8-4
- InertSustain C8
- Inertsil C8-3
- Inertsil C8-4
- ▲ InertSustain Phenyl
- ▲ Inertsil Ph-3

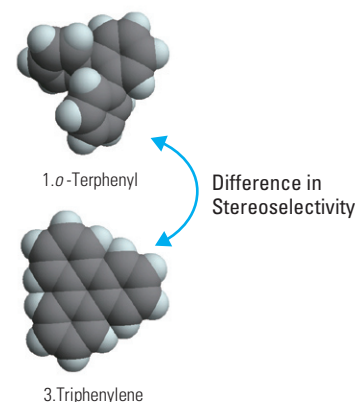

Conditions

Column Size : 5 μ m, 150 \times 4.6 mm I.D. Sample :

Eluent : A) CH₃OH 1. *o*-Terphenyl

 B) H₂O 2. *n*-Amylbenzene

 A / B = 70 / 30, v / v 3. Triphenylene

Flow Rate : 0.8 mL / min

Col. Temp. : 40 $^{\circ}$ C

Detection : UV 254 nm

InertSustain™ C18 Applications

Antidepressants

Effective for High Sensitivity analysis by LC/MS/MS

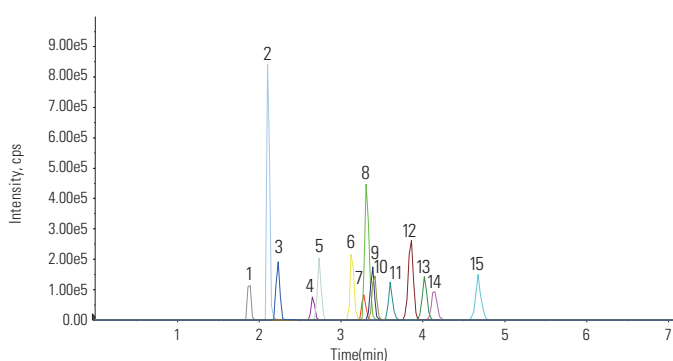

Conditions

System : LC800 HPLC system
4000 Q TRAP™

Column : InertSustain C18 (3 μ m, 150 \times 2.1 mm I.D.)

Eluent : A) 0.1 % HCOOH in CH₃CN
B) 0.1 % HCOOH in H₂O
A / B = 2 / 98 - 0.5 min - 40 / 60 - 5.5 min - 40 / 60, v / v

Flow Rate : 0.4 mL / min

Col. Temp. : 40 $^{\circ}$ C

Detection : LC / MS / MS (ESI, Positive, MRM)

Injection Vol. : 2 μ L

Sample : 1. Sulpilide 9. Nortriptyline
2. Milnacipran 10. Maprotiline
3. Trazodone 11. Amitriptyline
4. Amoxapine 12. Trimipramine
5. Doxepin 13. Fluoxetine
6. Desipramine 14. Sertraline
7. Fluvoxamine 15. Clomipramine
8. Imipramine (each 100 ng / mL)

Anthocyanins in Bilberry

Effective for Natural Plant Pigments

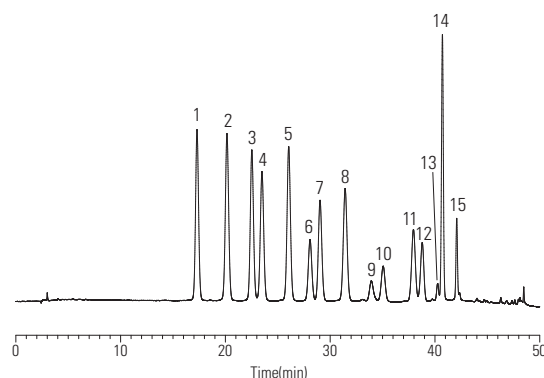

Conditions

System : LC800 HPLC system

Column : InertSustain C18 (5 μ m, 250 \times 4.6 mm I.D.)

Eluent : A) H₂O / HCOOH = 90 / 10
B) H₂O / CH₃CN / CH₃OH / HCOOH = 40 / 22.5 / 22.5 / 10
A / B = 93 / 7 - 35 min - 75 / 25 - 10 min - 35 / 65 - 1 min - 0 / 100
- 4 min - 0 / 100, v / v

Flow Rate : 1.0 mL / min

Col. Temp. : 30 $^{\circ}$ C

Detection : VIS 535 nm

Injection Vol. : 10 μ L

Sample : Bilberry powder (1.25 mg / mL)

1. Delphinidin-3-*O*-galactoside 9. Peonidin-3-*O*-galactoside
2. Delphinidin-3-*O*-glucoside 10. Petunidin-3-*O*-arabinoside
3. Cyanidin-3-*O*-galactoside 11. Peonidin-3-*O*-glucoside
4. Delphinidin-3-*O*-arabinoside 12. Malvidin-3-*O*-galactoside
5. Cyanidin-3-*O*-glucoside 13. Peonidin-3-*O*-arabinoside
6. Petunidin-3-*O*-galactoside 14. Malvidin-3-*O*-glucoside
7. Cyanidin-3-*O*-arabinoside 15. Malvidin-3-*O*-arabinoside
8. Petunidin-3-*O*-glucoside

Glycyrrhizins Effective for Herbal Medicine samples

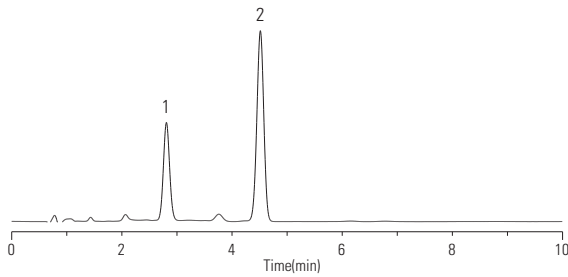

Conditions

Column : InertSustain C18 (5 µm, 150 × 4.6 mm I.D.)
 Eluent : A) CH₃CN
 B) 2.1 % CH₃COOH
 A / B = 40 / 60, v / v
 Flow Rate : 2 mL / min
 Col. Temp. : 40 °C
 Detection : UV 254 nm
 Injection Vol. : 20 µL
 Sample : 1. Glycyrrhizic acid dipotassium salt (250 mg / L)
 2. Propyl p-hydroxybenzoate (50 mg / L)

Organic Acids Compatible with 100 % aqueous mobile phases

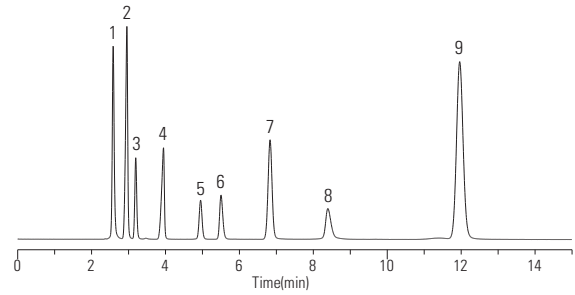

Conditions

Column : InertSustain C18 (5 µm, 250 × 4.6 mm I.D.)
 Eluent : 10 mM NH₄H₂PO₄ (pH 2.6, H₃PO₄)
 Flow Rate : 1.0 mL / min
 Col. Temp. : 40 °C
 Detection : UV 210 nm
 Injection Vol. : 10 µL

Sample :

1. Oxalic acid (100 mg / L)
2. Tartaric acid (1000 mg / L)
3. Glycolic acid (1000 mg / L)
4. Malonic acid (1000 mg / L)
5. Lactic acid (1000 mg / L)
6. Acetic acid (1000 mg / L)
7. Fumalic acid (10 mg / L)
8. Succinic acid (1000 mg / L)
9. Acrylic acid (100 mg / L)

Veterinary Drugs

InertSustain C18 (3 µm)

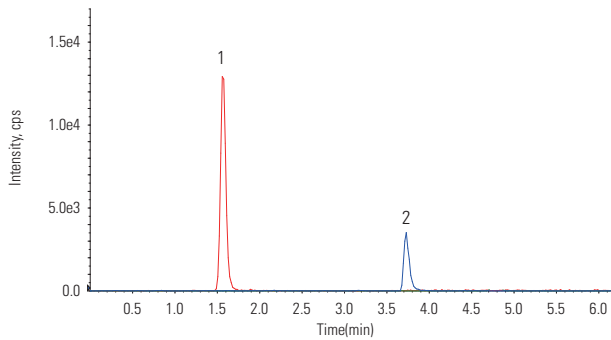

Conditions

System : LC800 HPLC System
 Column : ODS Column (100 × 2.1 mm I.D.)
 Eluent : A) 2 mM CH₃COONH₄ in 95 % CH₃CN
 B) 2 mM CH₃COONH₄ in 10 % CH₃CN
 A / B = 20 / 80 - 2 min - 100 / 0 - 2.5 min - 100 / 0 - 0.01 min - 20 / 80, v / v
 (Mixed by a gradient mixer)
 Flow Rate : 0.3 mL / min
 Col. Temp. : 40 °C
 Detection : LC / MS / MS
 (4000 Q TRAP™ - ESI, Positive, MRM)
 Injection Vol. : 10 µL
 Sample : 1. Nitrofurazone (100 µg / L)
 2. Lasalocid A (100 µg / L)

Kinetex C18 (1.7 µm)

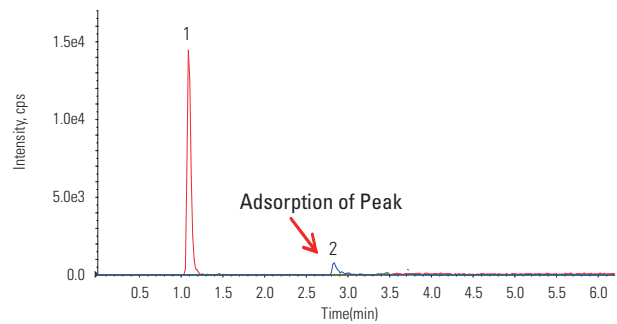

Valsartan

Effective for Generic Drugs

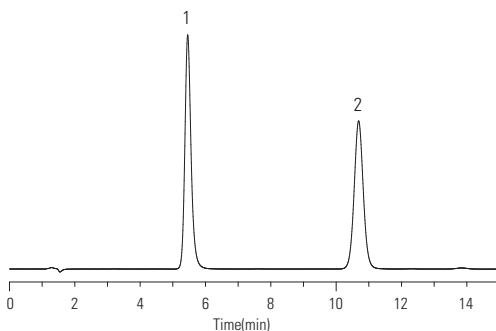

Conditions

Column : InertSustain C18 (5 µm, 125 × 3.0 mm I.D.)
 Eluent : A) CH₃CN
 B) H₂O
 C) CH₃COOH
 A / B / C = 500 / 500 / 1, v / v / v
 Flow Rate : 0.4 mL / min
 Col. Temp. : 25 °C
 Detection : UV 225 nm
 Injection Vol. : 10 µL
 Sample : 1. Valsartan (50 mg / L)
 2. Diclofenac sodium (60 mg / L)

InertSustain™ C8 Applications

Phospholipids Suitable for highly hydrophobic lipids

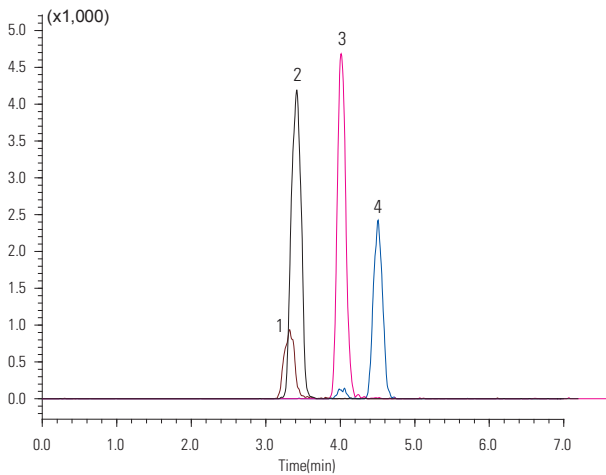

Conditions

System : Nexera LCMS-8030
 Column : InertSustain C8 (3 μm, 150 × 2.1 mm I.D.)
 Eluent : 0.1 % HCOOH, 5 mM HCOONH₄ in CH₃OH
 Flow Rate : 0.2 mL / min
 Col. Temp. : 40 °C
 Detection : LC / MS / MS (ESI, Negative, MRM)
 Injection Vol. : 2 μL
 Sample : 1. Phosphatidyl-L-Seryne (PS) (10 μg / mL)
 2. L-α-Phosphatidyl-DL-glycerol, Distearoyl (PG) (0.2 μg / mL)
 3. L-α-Phosphatidylcholine (PC) (0.05 μg / mL)
 4. L-α-Phosphatidylethanolamine, Distearoyl (PE) (0.5 μg / mL)

InertSustain™ Phenyl Applications

Preservatives, Sweeteners

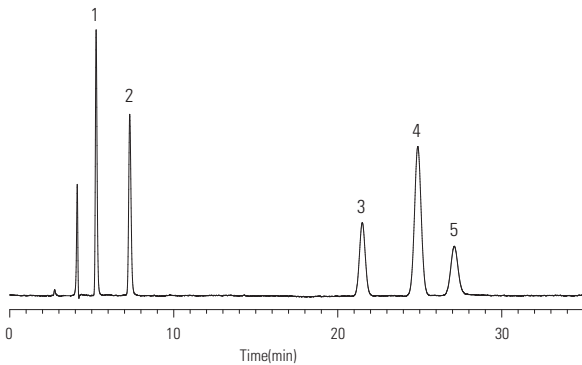

Conditions

Column : InertSustain Phenyl
 (5 μm, 250 × 4.6 mm I.D.)
 Eluent : A) CH₃CN
 B) 0.2 % HCOOH in H₂O
 A / B = 15 / 85, v / v
 Flow Rate : 1.0 mL / min
 Col. Temp. : 25 °C
 Detection : UV 230 nm
 Injection Vol. : 10 μL

Sample :
 1. Acesulfame potassium
 2. Saccharin
 3. Sorbic acid
 4. Benzoic acid
 5. Dehydroacetic acid
 (each 10 mg / L)

Anti-inflammatory Drugs

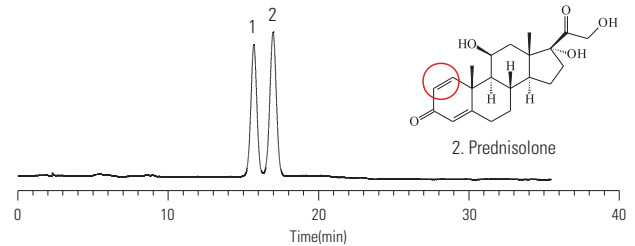
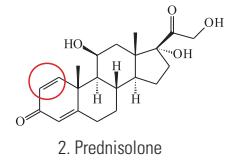
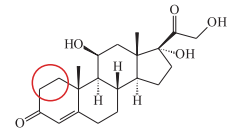

Conditions

Column : InertSustain Phenyl (5 μm, 150 × 4.6 mm I.D.)
 Eluent : A) CH₃OH
 B) H₂O
 A / B = 40 / 60, v / v
 Flow Rate : 0.8 mL / min
 Col. Temp. : 40 °C
 Detection : UV 220 nm
 Injection Vol. : 5 μL

InertSustain™ NH2 Applications

Vitamin E

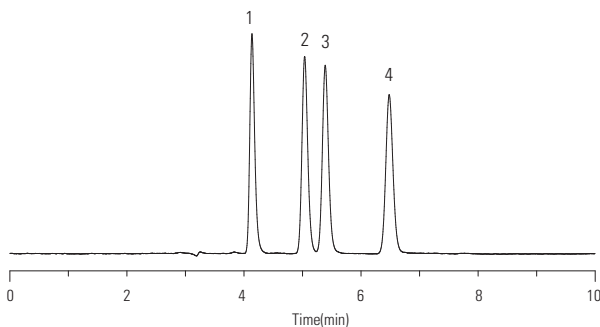

Conditions

Column : InertSustain NH2
 (5 μm, 250 × 4.6 mm I.D.)
 Eluent : A) n-Hexane B) Ethyl acetate
 A / B = 70 / 30, v / v
 Flow Rate : 1.0 mL / min
 Col. Temp. : 30
 Detection : UV 290 nm
 Injection Vol. : 10 μL

Sample :
 1. α-Tocopherol
 2. β-Tocopherol
 3. γ-Tocopherol
 4. δ-Tocopherol
 (each 25 mg / L)

Maximize Your Method Development Efficiency

Wide pH Compatibility

Efficient method development can be achieved at a wide range of pH, creating the possibility for unique selectivity changes to optimize your methods.

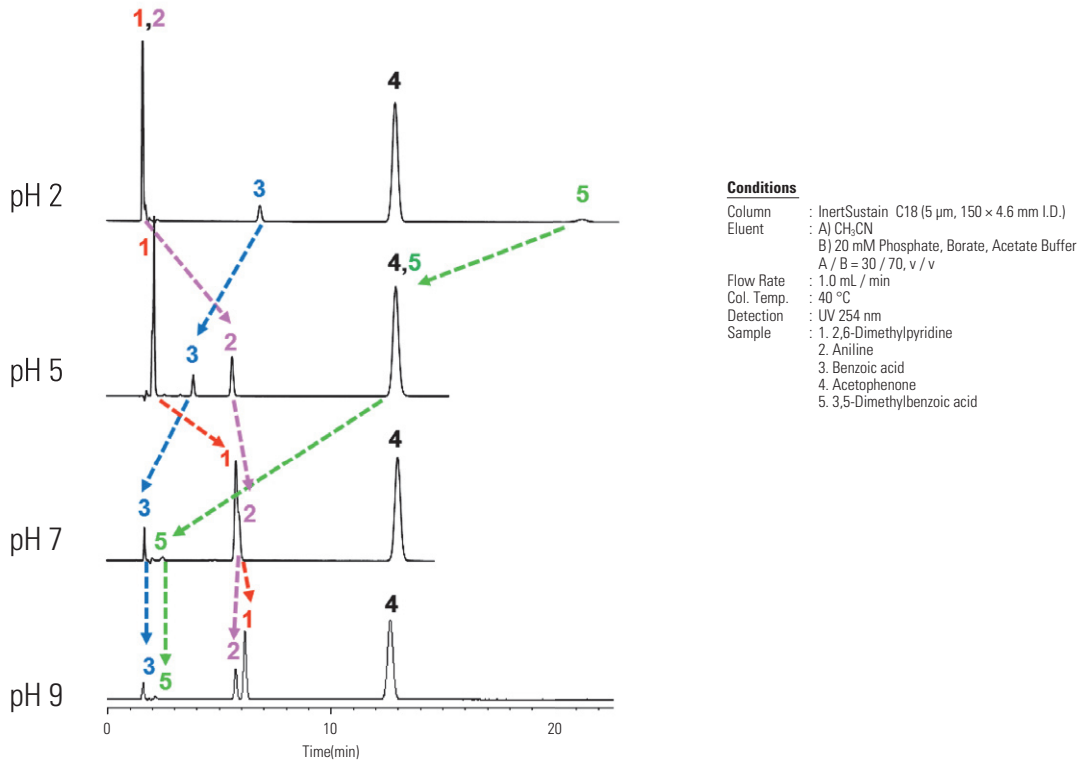

Basic Drugs **Increased Ionization Efficiency leading to Higher Sensitivity**

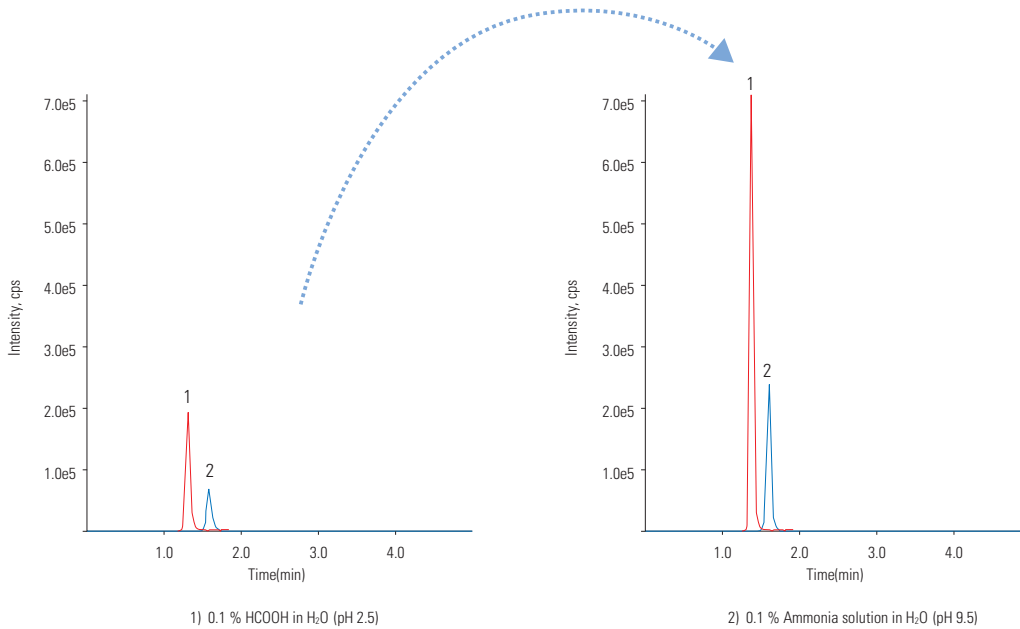

Conditions

- System : LC800 HPLC system
- Column : InertSustain C18 (3 μm, 75 × 2.1 mm I.D.)
- Eluent : 1) CH₃CN / 0.1 % HCOOH in H₂O (pH 2.5) = 10 / 90, v / v
2) CH₃CN / 0.1 % Ammonia solution (28 %) in H₂O (pH 9.5) = 30 / 70, v / v
- Flow Rate : 0.3 mL / min
- Col. Temp. : 40 °C
- Detection : LC / MS / MS
(4000 Q TRAP™ : ESI, Positive, MRM)

Sample :

- Ranitidine
- Sulpiride

HP (High Pressure) series 3 μm Columns

HP series 3 μm columns are compatible with high-throughput analysis operating up to 50 MPa. As shown below, equivalent efficiency to 2 μm columns can be observed by increasing the column length and flow rate.

Lower Back Pressure and Equivalent efficiency compared to 2 μm columns

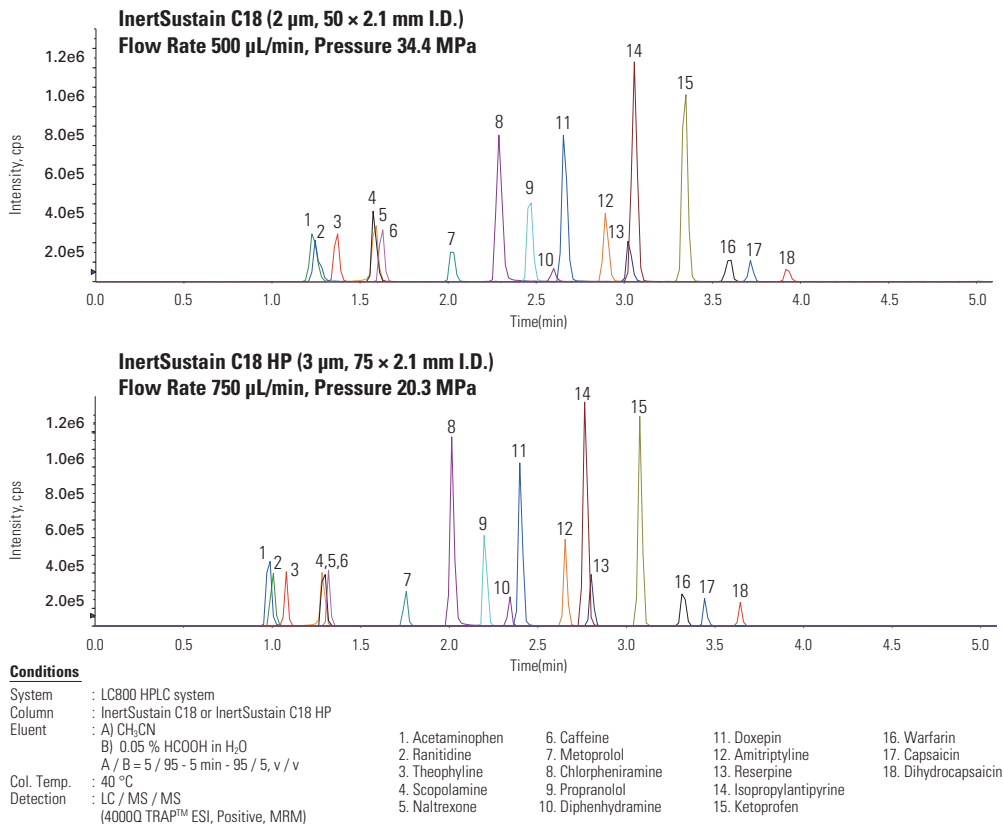

Preparative Chromatography

Influence of Chromatographic Results in various Mobile Phase Conditions

Berberine is a group of alkaloids. Higher sample loading capacity can be achieved under basic pH conditions rather than acidic or neutral conditions since Berberine does not dissociate and create a hydrophobic interaction.

The flexibility of InertSustain C18 offering wide pH compatibility delivers higher sample loading capacity resulting in higher efficiency compared to other ODS columns in the market

• Acidic Condition (0.5% Formic Acid, pH = 2)

Maximum Loading Capacity : 20 mg

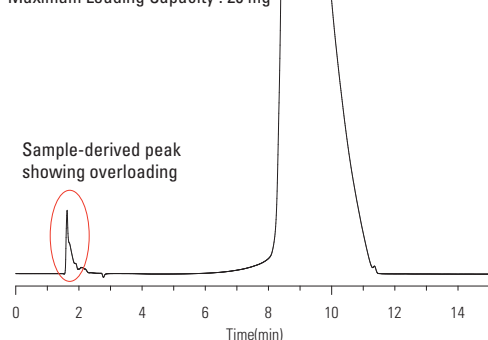

Under Basic Condition

Under Acidic Condition

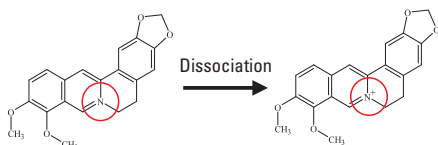

• Basic Condition (Ammonium Bicarbonate, pH = 10)

Maximum Loading Capacity : 35 mg

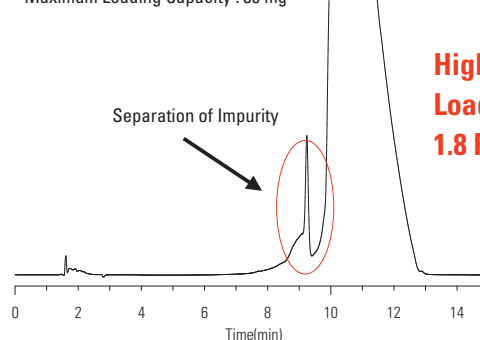

Higher Sample Loading Capacity 1.8 Folds

Conditions

System : PLC761 system
Column : InertSustain C18 (5 μm , 150 \times 20 mm I.D.)
Eluent : A) CH_3CN
B) 0.5 % Formic acid
or 25 mM Ammonium bicarbonate
A / B = 5 / 95 – 15 min – 65 / 35, v / v

Flow Rate : 18.9 mL / min
Col. Temp. : 35 $^\circ\text{C}$
Detection : UV 465 nm
Sample : Berberine

InertSustain™ C18 Analytical Columns

Particle Size : 2 µm Max. Operating Pressure: 80 MPa (800 Bar)	Length / I.D. (mm)	2.1	3.0
	30	5020-14351	5020-14361
	50	5020-14352	5020-14362
	75	5020-14353	5020-14363
	100	5020-14354	5020-14364
150	5020-14355	5020-14365	

HP Series Particle Size : 3 µm Max. Operating Pressure: 50 MPa (500 Bar)	Length / I.D. (mm)	2.1	3.0	4.6
	30	5020-14411	5020-14421	5020-14441
	50	5020-14412	5020-14422	5020-14442
	75	5020-14413	5020-14423	5020-14443
	100	5020-14414	5020-14424	5020-14444
	150	5020-14415	5020-14425	5020-14445
250	5020-14416	5020-14426	5020-14446	

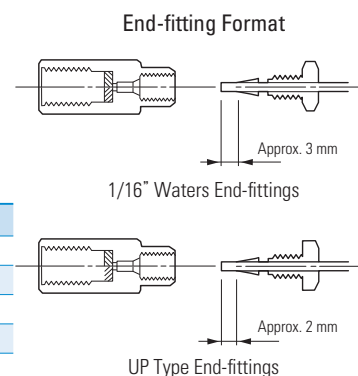

- ※ End-fittings are 1/16" Waters-compatible.
- ※ UHPLC compatible end-fittings are also available upon request for UHPLC systems (Ex: UPLC®) to avoid dead volume.
- ※ Indicate "UP Type end-fittings" when ordering. (Please note that UP type is not available for a 4.6 mm I.D. column)

UPLC® is a registered trademark of Waters Corporation.

Particle Size : 3 µm Max. Operating Pressure: 20 MPa (200 Bar)	Length / I.D. (mm)	1.0	1.5
	30	5020-14301	5020-14311
	50	5020-14302	5020-14312
	75	5020-14303	5020-14213
	100	5020-14304	5020-14314
	150	5020-14305	5020-14315
	250	5020-14306	5020-14316

Particle Size : 3 µm Max. Operating Pressure: 20 MPa (200 Bar)	Length / I.D. (mm)	2.1	3.0	4.0	4.6
	30	5020-07411	5020-07421	5020-07431	5020-07441
	50	5020-07412	5020-07422	5020-07432	5020-07442
	75	5020-07413	5020-07423	5020-07433	5020-07443
	100	5020-07414	5020-07424	5020-07434	5020-07444
	125	5020-07417	5020-07427	5020-07437	5020-07447
	150	5020-07415	5020-07425	5020-07435	5020-07445
	250	5020-07416	5020-07426	5020-07436	5020-07446

Particle Size : 5 µm Max. Operating Pressure: 20 MPa (200 Bar)	Length / I.D. (mm)	1.0	1.5
	30	5020-14201	5020-14211
	50	5020-14202	5020-14212
	75	5020-14203	5020-14213
	100	5020-14204	5020-14214
	150	5020-14205	5020-14215
	250	5020-14206	5020-14216

Particle Size : 5 µm Max. Operating Pressure: 20 MPa (200 Bar)	Length / I.D. (mm)	2.1	3.0	4.0	4.6
	30	5020-07311	5020-07321	5020-07331	5020-07341
	50	5020-07312	5020-07322	5020-07332	5020-07342
	75	5020-07313	5020-07323	5020-07333	5020-07343
	100	5020-07314	5020-07324	5020-07334	5020-07344
	125	5020-07317	5020-07327	5020-07337	5020-07348
	150	5020-07315	5020-07325	5020-07335	5020-07345
	250	5020-07316	5020-07326	5020-07336	5020-07346

- ※ End-fittings are 1/16" Waters-compatible.
- ※ Other column sizes available upon request.

InertSustain™ C18 Cartridge Guard Columns

I.D. of the Analytical Column Applicable (mm)	Length (mm)	I.D. (mm)	Replacement Cartridge E Guard Column (2 EA.)		Cartridge E Holder / Cartridge Set (2 Cartridge E Guard Columns & 1 Holder)	
			Particle Size		Particle Size	
			3 µm	5 µm	3 µm	5 µm
1.0	10	1.0	5020-19250	5020-19249	5020-19300	5020-19299
1.5, 2.1		1.5	5020-19350	5020-19349	5020-19400	5020-19399
2.1, 3.0		3.0	5020-19150	5020-19149	5020-19200	5020-19199
4.0, 4.6		4.0	5020-19050	5020-19049	5020-19100	5020-19099
2.1, 3.0	20	3.0	5020-19550	5020-19549	5020-19600	5020-19599
4.0, 4.6		4.0	5020-19450	5020-19449	5020-19500	5020-19499

※ Max. Operating Pressure: 20 MPa (200 Bar)

InertSustain™ C18 Preparative Columns

Particle Size : 5 µm	I.D. (mm)	6.0	7.6	10	14	20
	Length (mm)	Cat.No.	Cat.No.	Cat.No.	Cat.No.	Cat.No.
	50	5020-07352	5020-07362	5020-14252	5020-14262	5020-14272
	100	5020-07354	5020-07364	5020-14254	5020-14264	5020-14274
	150	5020-07355	5020-07365	5020-14255	5020-14265	5020-14275
	250	5020-07356	5020-07366	5020-14256	5020-14266	5020-14276

InertSustain™ C18 Preparative Guard Columns

Particle Size : 5 µm	I.D. x Length (mm)	Cat.No
		6.0 X 50
	7.6 X 50	5020-07367
	10 X 50	5020-14257
	14 X 50	5020-14267
	20 X 50	5020-14277

InertSustain™ C18 Capillary Columns

Capillary EX Columns

Particle Size	Length (mm)	I.D. 0.3 mm	I.D. 0.5 mm	I.D. 0.7 mm
		Cat.No.	Cat.No.	Cat.No.
3 µm	50	5020-11539	5020-11639	5020-11739
	150	5020-11589	5020-11689	5020-11789
5 µm	50	5020-11538	5020-11638	5020-11738
	150	5020-11588	5020-11688	5020-11788
Capillary EX Column Connection Kit			Cat.No.	5020-01880

Capillary EX-Nano Columns

Particle Size	Length (mm)	I.D. 0.05 mm	I.D. 0.075 mm	I.D. 0.1 mm	I.D. 0.2 mm
		Cat.No.	Cat.No.	Cat.No.	Cat.No.
3 µm	50	5020-15038	5020-15188	5020-15338	5020-15488
	150	5020-15088	5020-15238	5020-15388	5020-15538
	250	5020-15138	5020-15288	5020-15438	5020-15588
5 µm	50	5020-15037	5020-15187	5020-15337	5020-15487
	150	5020-15087	5020-15387	5020-15387	5020-15537
	250	5020-15137	5020-15437	5020-15437	5020-15587
Capillary EX-Nano Column Connection Kit				Cat.No.	5020-01881

InertSustain™ C8 Analytical Columns

HP Series Particle Size : 3 µm Max. Operating Pressure: 50 MPa (500 Bar)	Length / I.D. (mm)	2.1	3.0	4.6
	30	5020-16217	5020-16223	5020-16229
	50	5020-16218	5020-16224	5020-16230
	75	5020-16219	5020-16225	5020-16231
	100	5020-16220	5020-16226	5020-16232
	150	5020-16221	5020-16227	5020-16233
250	5020-16222	5020-16228	5020-16234	

※ End-fittings are 1/16" Waters-compatible.

※ UHPLC compatible end-fittings are also available upon request for UHPLC systems (Ex: UPLC®) to avoid dead volume.

※ Indicate "UP Type end-fittings" when ordering. (Please note that UP type is not available for a 4.6 mm I.D. column)

UPLC® is a registered trademark of Waters Corporation.

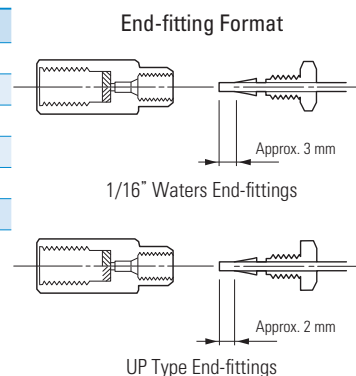

Particle Size : 3 µm Max. Operating Pressure: 20 MPa (200 Bar)	Length / I.D. (mm)	1.0	1.5		
	30	5020-16168	5020-16174		
	50	5020-16169	5020-16175		
	75	5020-16170	5020-16176		
	100	5020-16171	5020-16177		
	150	5020-16172	5020-16178		
250	5020-16173	5020-16179			
Max. Operating Pressure: 20 MPa (200 Bar)	Length / I.D. (mm)	2.1	3.0	4.0	4.6
	30	5020-16132	5020-16139	5020-16146	5020-16153
	50	5020-16133	5020-16140	5020-16147	5020-16154
	75	5020-16134	5020-16141	5020-16148	5020-16155
	100	5020-16135	5020-16142	5020-16149	5020-16156
	125	5020-16855	5020-16856	5020-16857	5020-16858
	150	5020-16136	5020-16143	5020-16150	5020-16157
	250	5020-16137	5020-16144	5020-16151	5020-16158

Particle Size : 5 µm Max. Operating Pressure: 20 MPa (200 Bar)	Length / I.D. (mm)	1.0	1.5		
	30	5020-16039	5020-16045		
	50	5020-16040	5020-16046		
	75	5020-16041	5020-16047		
	100	5020-16042	5020-16048		
	150	5020-16043	5020-16049		
250	5020-16044	5020-16050			
Max. Operating Pressure: 20 MPa (200 Bar)	Length / I.D. (mm)	2.1	3.0	4.0	4.6
	30	5020-16002	5020-16009	5020-16016	5020-16023
	50	5020-16003	5020-16010	5020-16017	5020-16024
	75	5020-16004	5020-16011	5020-16018	5020-16025
	100	5020-16005	5020-16012	5020-16019	5020-16026
	125	5020-16851	5020-16852	5020-16853	5020-16854
	150	5020-16006	5020-16013	5020-16020	5020-16027
	250	5020-16007	5020-16014	5020-16021	5020-16028

※ End-fittings are 1/16" Waters-compatible.

※ Other column sizes available upon request.

InertSustain™ C8 Cartridge Guard Columns

I.D. of the Analytical Column Applicable (mm)	Length (mm)	I.D. (mm)	Replacement Cartridge E Guard Column (2 EA.)		Cartridge E Holder / Cartridge Set (2 Cartridge E Guard Columns & 1 Holder)	
			Particle Size		Particle Size	
			3 µm	5 µm	3 µm	5 µm
1.0	10	1.0	5020-16207	5020-16106	5020-16208	5020-16107
1.5, 2.1		1.5	5020-16209	5020-16108	5020-16210	5020-16109
2.1, 3.0		3.0	5020-16205	5020-16104	5020-16206	5020-16105
4.0, 4.6		4.0	5020-16203	5020-16102	5020-16204	5020-16103
2.1, 3.0	20	3.0	5020-16213	5020-16112	5020-16214	5020-16113
4.0, 4.6		4.0	5020-16211	5020-16110	5020-16212	5020-16111

※ Max. Operating Pressure: 20 MPa (200 Bar)

InertSustain™ C8 Preparative Columns

Particle Size : 5 µm	I.D. (mm)	6.0	7.6	10	14	20
	Length (mm)	Cat.No.	Cat.No.	Cat.No.	Cat.No.	Cat.No.
	50	5020-16055	5020-16059	5020-16063	5020-16067	5020-16071
	100	5020-16056	5020-16060	5020-16064	5020-16068	5020-16072
	150	5020-16057	5020-16061	5020-16065	5020-16069	5020-16073
	250	5020-16058	5020-16062	5020-16066	5020-16070	5020-16074

InertSustain™ C8 Preparative Guard Columns

Particle Size : 5 µm	I.D. x Length (mm)	Cat.No
		6.0 X 50
	7.6 X 50	5020-16076
	10 X 50	5020-16077
	14 X 50	5020-16078
	20 X 50	5020-16079

InertSustain™ C8 Capillary Columns

Capillary EX Columns

Particle Size	Length (mm)	I.D. 0.3 mm	I.D. 0.5 mm	I.D. 0.7 mm
		Cat.No.	Cat.No.	Cat.No.
3 µm	50	5020-16184	5020-16186	5020-16188
	150	5020-16185	5020-16187	5020-16189
5 µm	50	5020-16082	5020-16084	5020-16086
	150	5020-16083	5020-16085	5020-16087
Capillary EX Column Connection Kit			Cat.No.	5020-01880

Capillary EX-Nano Columns

Particle Size	Length (mm)	I.D. 0.05 mm	I.D. 0.075 mm	I.D. 0.1 mm	I.D. 0.2 mm
		Cat.No.	Cat.No.	Cat.No.	Cat.No.
3 µm	50	5020-16191	5020-16194	5020-16197	5020-16200
	150	5020-16192	5020-16195	5020-16198	5020-16201
	250	5020-16193	5020-16196	5020-16199	5020-16202
5 µm	50	5020-16090	5020-16093	5020-16096	5020-16099
	150	5020-16091	5020-16094	5020-16097	5020-16100
	250	5020-16092	5020-16095	5020-16098	5020-16101
Capillary EX-Nano Column Connection Kit				Cat.No.	5020-01881

InertSustain™ Phenyl Analytical Columns

HP Series Particle Size : 3 µm Max. Operating Pressure: 50 MPa (500 Bar)	Length / I.D. (mm)	2.1	3.0	4.6
	30	5020-16517	5020-16523	5020-16529
	50	5020-16518	5020-16524	5020-16530
	75	5020-16519	5020-16525	5020-16531
	100	5020-16520	5020-16526	5020-16532
	150	5020-16521	5020-16527	5020-16533
250	5020-16522	5020-16528	5020-16534	

※ End-fittings are 1/16" Waters-compatible.

※ UHPLC compatible end-fittings are also available upon request for UHPLC systems (Ex: UPLC®) to avoid dead volume.

※ Indicate "UP Type end-fittings" when ordering. (Please note that UP type is not available for a 4.6 mm I.D. column)

UPLC® is a registered trademark of Waters Corporation.

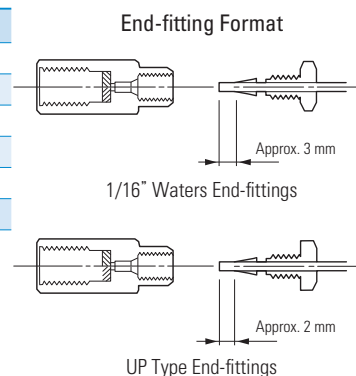

Particle Size : 3 µm Max. Operating Pressure: 20 MPa (200 Bar)	Length / I.D. (mm)	1.0	1.5		
	30	5020-16468	5020-16474		
	50	5020-16469	5020-16475		
	75	5020-16470	5020-16476		
	100	5020-16471	5020-16477		
	150	5020-16472	5020-16478		
250	5020-16473	5020-16479			
	Length / I.D. (mm)	2.1	3.0	4.0	4.6
	30	5020-16432	5020-16439	5020-16446	5020-16453
	50	5020-16433	5020-16440	5020-16447	5020-16454
	75	5020-16434	5020-16441	5020-16448	5020-16455
	100	5020-16435	5020-16442	5020-16449	5020-16456
	150	5020-16436	5020-16443	5020-16450	5020-16457
	250	5020-16437	5020-16444	5020-16451	5020-16458

Particle Size : 5 µm Max. Operating Pressure: 20 MPa (200 Bar)	Length / I.D. (mm)	1.0	1.5		
	30	5020-16339	5020-16345		
	50	5020-16340	5020-16346		
	75	5020-16341	5020-16347		
	100	5020-16342	5020-16348		
	150	5020-16343	5020-16349		
250	5020-16344	5020-16350			
	Length / I.D. (mm)	2.1	3.0	4.0	4.6
	30	5020-16302	5020-16309	5020-16316	5020-16323
	50	5020-16303	5020-16310	5020-16317	5020-16324
	75	5020-16304	5020-16311	5020-16318	5020-16325
	100	5020-16305	5020-16312	5020-16319	5020-16326
	150	5020-16306	5020-16313	5020-16320	5020-16327
	250	5020-16307	5020-16314	5020-16321	5020-16328

※ End-fittings are 1/16" Waters-compatible.

※ Other column sizes available upon request.

InertSustain™ Phenyl Cartridge Guard Columns

I.D. of the Analytical Column Applicable (mm)	Length (mm)	I.D. (mm)	Replacement Cartridge E Guard Column		Cartridge E Holder / Cartridge Set	
			(2 EA.)		(2 Cartridge E Guard Columns & 1 Holder)	
			Particle Size		Particle Size	
			3 µm	5 µm	3 µm	5 µm
1.0	10	1.0	5020-16507	5020-16406	5020-16508	5020-16407
1.5, 2.1		1.5	5020-16509	5020-16408	5020-16510	5020-16409
2.1, 3.0		3.0	5020-16505	5020-16404	5020-16506	5020-16405
4.0, 4.6		4.0	5020-16503	5020-16402	5020-16504	5020-16403
2.1, 3.0	20	3.0	5020-16513	5020-16412	5020-16514	5020-16413
4.0, 4.6		4.0	5020-16511	5020-16410	5020-16512	5020-16411

※ Max. Operating Pressure: 20 MPa (200 Bar)

InertSustain™ Phenyl Preparative Columns

Particle Size : 5 µm	I.D. (mm)	6.0	7.6	10	14	20
	Length (mm)	Cat.No.	Cat.No.	Cat.No.	Cat.No.	Cat.No.
	50	5020-16355	5020-16359	5020-16363	5020-16367	5020-16371
	100	5020-16356	5020-16360	5020-16364	5020-16368	5020-16372
	150	5020-16357	5020-16361	5020-16365	5020-16369	5020-16373
	250	5020-16358	5020-16362	5020-16366	5020-16370	5020-16374

InertSustain™ Phenyl Preparative Guard Columns

Particle Size : 5 µm	I.D. x Length (mm)	Cat.No
		6.0 X 50
	7.6 X 50	5020-16376
	10 X 50	5020-16377
	14 X 50	5020-16378
	20 X 50	5020-16379

InertSustain™ Phenyl Capillary Columns

Capillary EX Columns

Particle Size	Length (mm)	I.D. 0.3 mm	I.D. 0.5 mm	I.D. 0.7 mm
		Cat.No.	Cat.No.	Cat.No.
3 µm	50	5020-16484	5020-16486	5020-16488
	150	5020-16485	5020-16487	5020-16489
5 µm	50	5020-16382	5020-16384	5020-16386
	150	5020-16383	5020-16385	5020-16387
Capillary EX Column Connection Kit			Cat.No.	5020-01880

Capillary EX-Nano Columns

Particle Size	Length (mm)	I.D. 0.05 mm	I.D. 0.075 mm	I.D. 0.1 mm	I.D. 0.2 mm
		Cat.No.	Cat.No.	Cat.No.	Cat.No.
3 µm	50	5020-16491	5020-16494	5020-16497	5020-16500
	150	5020-16492	5020-16495	5020-16498	5020-16501
	250	5020-16493	5020-16496	5020-16499	5020-16502
5 µm	50	5020-16390	5020-16393	5020-16396	5020-16399
	150	5020-16391	5020-16394	5020-16397	5020-16400
	250	5020-16392	5020-16395	5020-16398	5020-16401
Capillary EX-Nano Column Connection Kit				Cat.No.	5020-01881

InertSustain™ NH2 Analytical Columns

Particle Size : 3 µm Max. Operating Pressure: 20 MPa (200 Bar)	Length / I.D. (mm)	1.0	1.5		
	30	5020-16768	5020-16774		
	50	5020-16769	5020-16775		
	75	5020-16770	5020-16776		
	100	5020-16771	5020-16777		
	150	5020-16772	5020-16778		
	250	5020-16773	5020-16779		
	Length / I.D. (mm)	2.1	3.0	4.0	4.6
	30	5020-16732	5020-16739	5020-16746	5020-16753
	50	5020-16733	5020-16740	5020-16747	5020-16754
	75	5020-16734	5020-16741	5020-16748	5020-16755
	100	5020-16735	5020-16742	5020-16749	5020-16756
	150	5020-16736	5020-16743	5020-16750	5020-16757
	250	5020-16737	5020-16744	5020-16751	5020-16758
	Particle Size : 5 µm Max. Operating Pressure: 20 MPa (200 Bar)	Length / I.D. (mm)	1.0	1.5	
		30	5020-16639	5020-16645	
50		5020-16640	5020-16646		
75		5020-16641	5020-16647		
100		5020-16642	5020-16648		
150		5020-16643	5020-16649		
250		5020-16644	5020-16650		
Length / I.D. (mm)		2.1	3.0	4.0	4.6
30		5020-16602	5020-16609	5020-16616	5020-16623
50		5020-16603	5020-16610	5020-16617	5020-16624
75		5020-16604	5020-16611	5020-16618	5020-16625
100		5020-16605	5020-16612	5020-16619	5020-16626
150		5020-16606	5020-16613	5020-16620	5020-16627
250		5020-16607	5020-16614	5020-16621	5020-16628

※ End-fittings are 1/16" Waters-compatible.

※ Other column sizes available upon request.

InertSustain™ NH2 Cartridge Guard Columns

I.D. of the Analytical Column Applicable (mm)	Length (mm)	I.D. (mm)	Replacement Cartridge E Guard Column		Cartridge E Holder / Cartridge Set	
			(2 EA.)		(2 Cartridge E Guard Columns & 1 Holder)	
			Particle Size		Particle Size	
			3 µm	5 µm	3 µm	5 µm
1.0	10	1.0	5020-16807	5020-16706	5020-16808	5020-16707
1.5, 2.1		1.5	5020-16809	5020-16708	5020-16810	5020-16709
2.1, 3.0		3.0	5020-16805	5020-16704	5020-16806	5020-16705
4.0, 4.6		4.0	5020-16803	5020-16702	5020-16804	5020-16703
2.1, 3.0	20	3.0	5020-16813	5020-16712	5020-16814	5020-16713
4.0, 4.6		4.0	5020-16811	5020-16710	5020-16812	5020-16711

※ Max. Operating Pressure: 20 MPa (200 Bar)

InertSustain™ NH2 Preparative Columns

Particle Size : 5 µm	I.D. (mm)	6.0	7.6	10	14	20
	Length (mm)	Cat.No.	Cat.No.	Cat.No.	Cat.No.	Cat.No.
	50	5020-16655	5020-16659	5020-16663	5020-16667	5020-16671
	100	5020-16656	5020-16660	5020-16664	5020-16668	5020-16672
	150	5020-16657	5020-16661	5020-16665	5020-16669	5020-16673
	250	5020-16658	5020-16662	5020-16666	5020-16670	5020-16674

InertSustain™ NH2 Preparative Guard Columns

Particle Size : 5 µm	I.D. x Length (mm)	Cat.No
		6.0 X 50
	7.6 X 50	5020-16676
	10 X 50	5020-16677
	14 X 50	5020-16678
	20 X 50	5020-16679

InertSustain™ NH2 Capillary Columns

Capillary EX Columns

Particle Size	Length (mm)	I.D. 0.3 mm	I.D. 0.5 mm	I.D. 0.7 mm
		Cat.No.	Cat.No.	Cat.No.
3 µm	50	5020-16784	5020-16786	5020-16788
	150	5020-16785	5020-16787	5020-16789
5 µm	50	5020-16682	5020-16684	5020-16686
	150	5020-16683	5020-16685	5020-16687
Capillary EX Column Connection Kit			Cat.No.	5020-01880

Capillary EX-Nano Columns

Particle Size	Length (mm)	I.D. 0.05 mm	I.D. 0.075 mm	I.D. 0.1 mm	I.D. 0.2 mm
		Cat.No.	Cat.No.	Cat.No.	Cat.No.
3 µm	50	5020-16791	5020-16794	5020-16797	5020-16800
	150	5020-16792	5020-16795	5020-16798	5020-16801
	250	5020-16793	5020-16796	5020-16799	5020-16802
5 µm	50	5020-16690	5020-16693	5020-16696	5020-16699
	150	5020-16691	5020-16694	5020-16697	5020-16700
	250	5020-16692	5020-16695	5020-16698	5020-16701
Capillary EX-Nano Column Connection Kit				Cat.No.	5020-01881

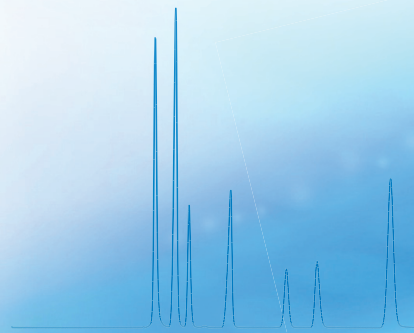

Worldwide Ordering Information

To find your local distributor, please visit our website at

<http://www.glsciences.com/distributors/>

Simply select your country from the list and your local distributor information will be displayed.

* All trademarks are the property of their respective owners.

• We reserve the right to change specifications to make improvements without notice.

GL Sciences Inc.

22-1 Nishishinjuku 6-chome, Shinjuku-ku,
Tokyo 163-1130. Japan
Tel. +81-3-5323-6620 Fax. +81-3-5323-6621
<http://www.glsciences.com>
E-mail: world@glsc.co.jp

Distributor:

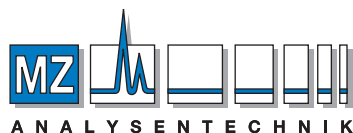

AUTHORIZED DISTRIBUTOR

MZ-Analysentechnik GmbH, Barcelona-Allee 17• D-55129 Mainz
Tel +49 6131 880 96-0, Fax +49 6131 880 96-20
e-mail: info@mz-at.de, www.mz-at.de