

WHEATON[®] PRODUCT CATALOG 2018



**DURAN
WHEATON
KIMBLE**

Excellence in your hands

DWK Life Sciences

THE NEW NAME FOR PREMIUM LABORATORY PRODUCTS

In June 2017 the companies DURAN Group, Wheaton Industries and Kimble Chase merged to form a new global company – DWK Life Sciences.

DWK Life Sciences combines the expertise of the acclaimed product brands DURAN®, WHEATON® and KIMBLE®. As one of the world's leading manufacturers of premium lab glass, DWK Life Sciences offers its customers a complete range of high-quality laboratory glassware – from the classic disposables to reusable precision glassware. Additionally, DWK Life Sciences develops and produces a wide range of plastic labware and specialty products for life science applications as well as packaging and storage solutions for the pharmaceutical industry.

The DWK Life Sciences product portfolio comprises over 30,000 products manufactured at 11 sites in Europe, North America and Asia. Globally, more than 1,700 employees work on the development and production of innovative products and services to meet the high expectations of customers in laboratories around the world – inspired by the company slogan "Excellence in your hands".

WHEATON®

EXCELLENT PRODUCTS FOR RESEARCH AND INDUSTRY

Satisfied customers, scientists and trading partners around the world put their trust in WHEATON® products. The WHEATON® brand is characterized by years of experience in the development and manufacture of containers made from glass and plastic. Today, the WHEATON® portfolio not only includes innovative products for the Life Science laboratory, but also instruments, customized container solutions and closure systems for research and industry.

Our experienced product managers and sales representatives would be delighted to assist.

See DWK-LifeSciences.com for how to get in touch with your contact persons, as well as much more information about WHEATON® and DWK Life Sciences.



Find out more:
www.DWK-LifeSciences.com



01

AMPULES

02

BOTTLES, GLASS

03

BOTTLES, PLASTIC

04

CAPS & CLOSURES

05

CELL CULTURE

06

CHEMISTRY GLASSWARE

07

CHROMATOGRAPHY

08

ENVIRONMENTAL

09

VIALS

10

TECHNICAL DATA

Table of Contents

Ampules

- > Ampule Snapper..... 7
- > Cryule® Cryogenic..... 7
- > Standard 7
- > Vacule® Lyophilization 7

Bottles, Glass

- > Cap Liner Specifications 12
- > Dropping 11
- > General Purpose..... 12-20
- > Safety Coated 21-22
- > Screw Neck Diagnostic..... 23
- > Serum 23-24
- > Snap Cap Bottles..... 24
- > Uni-Dose® 24

Bottles, Plastic

- > Diagnostic..... 31
- > Dispensing..... 30
- > Dropping 29-30
- > General Purpose..... 28
- > Leak Resistant 27
- > Media..... 31
- > PETG Media..... 32
- > Resin Identification Codes 32
- > Serum 31
- > Spray..... 30

Caps & Closures

- > Aluminum Seals 37-38
- > Crimpers & Decappers 39-40
- > Microlink® Cap..... 45
- > Rubber Stoppers 35-36
- > Screw Caps 41-47
 - Black Phenolic Screw Caps 41-42
 - GL45 Screw Caps..... 46
 - Liquid Scintillation Vials Caps 45
 - Polypropylene Screw Caps 43-44, 47
 - Septa for Open Top Caps 45
- > Snap Caps..... 47

Cell Culture

- > Bench-Top Systems..... 57-58
- > CELLline™ Bioreactors..... 51
- > Culture Flasks 64
- > Culture Tubes 63
- > Erlenmeyer Shake Flasks 52
- > Homogenizers 55
- > Hybridization Bottles 63
- > Incubators 56
- > Magnetic Stirrers 57
- > Roller Apparatus 53-55
- > Roller Bottles..... 55
- > Spinner Flasks 65
- > Staining Ware 59-60
- > Tissue Grinders 61-63

Chemistry Glassware

- > Adapters & Connectors 69
- > Arsine Generator 70
- > Chemistry Kit..... 73
- > Cyanide Distillation..... 70
- > Diazomethane Generator..... 71
- > Evaporative Concentrator..... 71
- > Filtration Apparatus 75-78
- > Soxhlet Extraction Apparatus 71

Chromatography

- > Autosampler Vial Sizer..... 93-94
- > Crimp Top Vials..... 86-88
- > Crimp Top / Snap Ring Vials 89-90
- > Crimpers & Decappers 39-40
- > Headspace Vials 92
- > Instrument Compatibility Guide..... 95-96
- > LVI™ Vials 83, 88
- > Plastic Vials 84, 89
- > Screw Cap Vials..... 81-85
- > Shell Vials..... 91
- > Vial Racks..... 124

Environmental

> BOD Bottles.....	99
> BOD Accessories.....	100
> Bomb Sampler.....	101
> Coliwesas.....	101
> Drum Openers.....	104
> Drum Thieves.....	101
> EPA Vials.....	103
> E-Z Sampler®.....	102
> Grab Sampler® I-III.....	102
> Imhoff Cone.....	104
> Oil Sample Bottle.....	104
> Scoop, Stainless Steel.....	104
> Weighing Dishes.....	103

Vials

> Bar Code Readers.....	109
> Cap Liner Guide.....	111
> CryoELITE®.....	107-108
> Cryogenic.....	107-110
> Diagnostic.....	123
> Dilution Vial.....	114
> EPA.....	114
> E-Z Ex-Traction®.....	120
> E-Z MicroTubes.....	108
> Freezer Boxes.....	110
> Liquid Scintillation.....	112-113
> Racks.....	110, 124
> Sample.....	116-119
> Sample Vial Sizer Guide.....	115
> Serum.....	122
> Tissue Vial.....	107
> Vacule®.....	122
> Vial File®.....	124
> Vial for Environmental Analysis.....	114
> V-Vials®.....	121

Technical Data

> Chemical Compatibility Chart.....	148
> Closures.....	127-130
> Common Conversion Factors.....	147
> Glass.....	131-137
> Plastic.....	138-144
> Plug Styles.....	145-146
> Sterilization.....	135, 142-144





The Highest Sample Integrity for Long-Term Storage

Ampules

WHEATON® ampules are all glass containers that can be hermetically sealed to preserve sample purity and extend sample shelf life. WHEATON ampules are ideal for standards packaging, environmental and diagnostic standards, lyophilization and cryogenic storage. These ampules protect against sample contamination due to their tamper-evident seal. A Gold Band® on the stem of the ampule indicates that the ampule is pre-scored to facilitate snapping off the top of the ampule eliminating the need to file the ampule. The ampule line includes pre-scored, standard, glass Cryule® cryogenic ampules and Vacule® lyophilization ampules. DWK Life Sciences can also design a custom ampule to fit your special requirements.

Sample Traceability Using WHEATON Cryule® Cryogenic Ampules

- Glass ampules provide the highest sample integrity for long-term storage. Since ampules are not provided pre-bar coded, DWK Life Sciences provides customization of bar codes according to customer specifications.
- A ceramic two dimensional (2D) or linear bar code can be applied to the ampule. The ceramic bar code is durable when used in extreme temperatures.

- 2D bar codes are machine readable symbols of rows of encrypted data arranged in a rectangular or square pattern that stores large amounts of data.
- Linear bar codes are black and white vertical bars located on the side of the ampule that contain various amounts of data ranging from simple number chains to large amounts of numeric and alphanumeric data sets.
- Number sequencing on bar codes is guaranteed not to duplicate.
- Once the 2D bar code is applied to the ampule, the bar code can be scanned and read using the WHEATON SingleScan™ (Cat. No. W986000) or the WHEATON PluraScan™ Bar Code Reader (Cat. No. W986010).
- Bar code identification can be simply stored in a Microsoft® Excel® file or any other data collection system.
- DWK Life Sciences can also manufacture a custom ampule and provide critical cleaning and sterilization services.

Ampules

- > Ampule Snapper..... 7
- > Cryule® Cryogenic..... 7
- > Standard..... 7
- > Vacule® Lyophilization..... 7

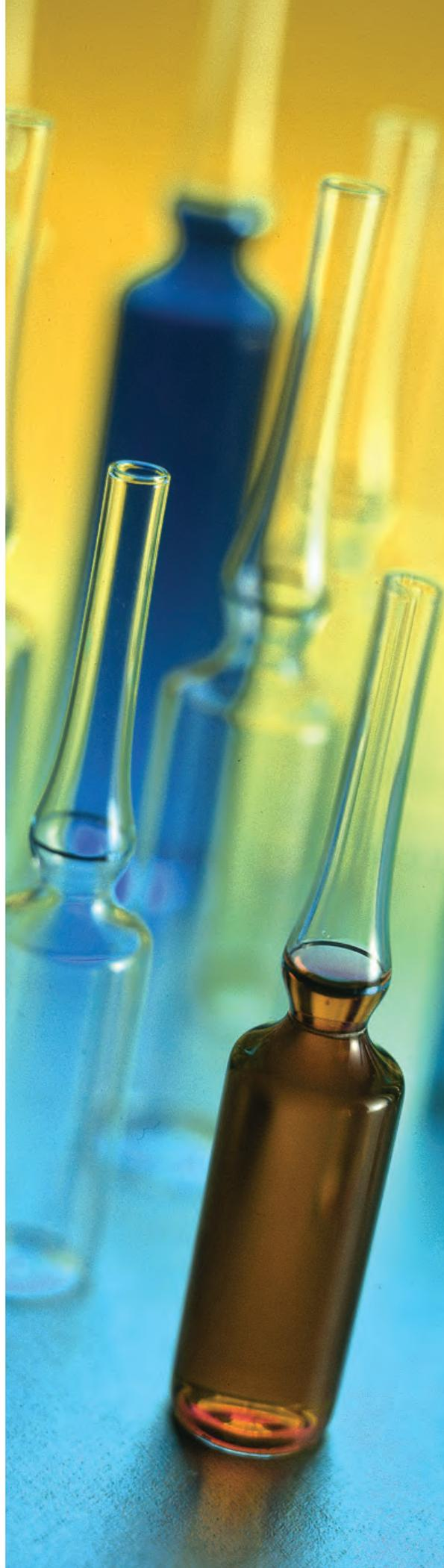

Cryule® Cryogenic Ampule

- For biological sample preservation in glass
- Allows for storage at low temperatures
- Made from low extractable borosilicate glass that conforms to USP Type I and ASTM E 438 Type I, Class A requirements
- Can be used in the vapor phase of liquid nitrogen
- Special design allows for storage at low temperatures as well as rapid thawing



Cat. No.	Size (mL)	Dia. x H (mm)	*OD at Top (mm)	Qty / Case
651463	1.2	11.8 x 58	5	144
W651469	5	16.5 x 98	8	293

* Approximate OD

Cryule® Cryogenic Ampule, Pre-scored

- For biological sample preservation in glass
- Pre-scored to eliminate filing
- Allows for storage at low temperatures
- Made from low extractable borosilicate glass that conforms to USP Type I and ASTM E 438 Type I, Class A requirements
- Can be used in the vapor phase of liquid nitrogen
- Special design allows for storage at low temperatures as well as rapid thawing



Cat. No.	Size (mL)	Dia. x H (mm)	*OD at Top (mm)	Qty / Case
651483	1.2	11.8 x 58	5	144
651486	2	11.5 x 70	5	144

* Approximate OD

Vacule® Lyophilization Ampule

- Ideal for small volume lyophilization samples
- Made from low extractable borosilicate glass that conforms to USP Type I and ASTM E 438 Type I, Class A requirements
- Heat or stopper sealed
- To stopper seal, use WHEATON Stopper W651450



Cat. No.	Description	Dia. x H (mm)	Qty / Case
W651446	2mL Vacule	12 x 86	567
W651450	11mm Gray Butyl Stopper	—	144

* Approximate OD at top 10mm

Vacule® Lyophilization Ampule, Pre-scored

- Ideal for small volume lyophilization samples
- Pre-scored for easy opening
- Made from low extractable borosilicate glass that conforms to USP Type I and ASTM E 438 Type I, Class A requirements
- Heat sealed only



Cat. No.	Size (mL)	Dia. x H (mm)	*OD at Top (mm)	Qty / Case
651502	1	10 x 108	10	144
W651506	2	11.8 x 122	11.75	567

* Approximate OD

Clear Ampule, Pre-scored

- Pre-scored to eliminate filing
- Made from low extractable borosilicate glass that conforms to USP Type I and ASTM E 438 Type I, Class A requirements
- Stems can be pull or tip sealed



Cat. No.	Size (mL)	Dia. x H (mm)	Qty / Case
176772	1	10.5 x 67	144
176776	2	12 x 75	144
176779	5	16.5 x 84	144
176780	10	19 x 107	144
176782	20	22.5 x 130	144

Amber Ampule, Pre-scored

- Pre-scored to eliminate filing
- Made from amber borosilicate glass that conforms to USP Type I requirements for light transmission to protect light-sensitive products
- Stems can be pull or tip sealed



Cat. No.	Size (mL)	Dia. x H (mm)	Qty / Case
176792	1	10.5 x 67	144
176796	2	12 x 75	144
176799	5	16.5 x 84	144

Ampule, Standard

- Commonly used for packaging certified standards
- Consistent with low background counts
- Made from low potassium borosilicate glass that conforms to USP Type I and ASTM E 438 Type I, Class A requirements



Cat. No.	Size (mL)	Dia. x H (mm)	Qty / Case
176759	7	17 x 95	25
176762	20	28 x 100	25

Ampule Snapper, Disposable

- Protects against glass splinters
- Prevents cross contamination



Cat. No.	For Ampule Size	Qty / Case
177105	1 and 2mL	144





Containers for All Purposes

Glass Bottles

The WHEATON® portfolio offers over 3,000 containers and closures from borosilicate to soda-lime glass. Each container has an assortment of caps and liners to choose from. We are able to provide small case quantities of containers as well as large bulk packs. We also offer the ability to customize your order to meet all your needs. In addition, DWK Life Sciences offers convenience bulk packs of containers with or without caps attached for high use items or facilities with centralized stockrooms. Tamper Evident Seal / HAZCOM Label provided in each case of bottles with the exception of bulk packs.

The United States Pharmacopeia classifies pharmaceutical glass containers according to their resistance to water attack, also referred to as chemical durability. Containers are classified as Type I, II, and III. Type I is the most durable glass, and Type III is the least durable glass. Test methods and specification limits for determining the chemical resistance of glass can be found in the current revision of the U. S. Pharmacopeia, section <660> Containers. Most of the glass containers offered by DWK Life Sciences are manufactured from either Type I borosilicate or Type III soda-lime glass.

Glass in the USP Type I classification are borosilicate glass with superior chemical resistance. This class of glasses represents the least reactive glass containers available. Typically, this glass can be used for most applications, including packaging for parenteral and nonparenteral products. Type I glass may be

used to package acidic, neutral and alkaline products. Water for injection, un-buffered products, chemicals, sensitive products and those requiring sterilization are commonly packaged in Type I borosilicate glass. Type I glass can be subject to chemical attack under certain conditions, thus container selection must be made carefully for very low and very high pH applications.

USP Type III is a soda-lime glass with moderate chemical resistance. It is typically acceptable for packaging dry powders that will be dissolved into solutions or buffers that are insensitive to alkali. Type III glass may not be suitable for autoclaved products because the autoclaving process will accelerate the glass corrosion reaction. Dry heat sterilization processes are typically not a problem for Type III containers. Light sensitive products must be packaged in amber glass. Amber glass is formulated to absorb light in the Ultra Violet region of the electromagnetic spectrum.

Bottles, Glass

- > Cap Liner Specifications 12
- > Dropping 11
- > General Purpose..... 12-20
- > Safety Coated21-22
- > Screw Neck Diagnostic.....23
- > Serum.....23-24
- > Snap Cap Bottles24
- > Uni-Dose®24





Dropping Bottle, All Glass

- Delivers stains or indicator solutions drop by drop
- Available in clear or amber glass
- Complete with a glass stopper
- A partial turn of the ground glass stopper seals the bottle
- Manufactured from soda-lime glass
- Not autoclavable



Cat. No.	Color	Capacity (mL)	Dia. x H (mm)	Qty / Case
W211734	Clear	50	45 x 95	6
W211754	Amber	50	45 x 95	6
W211735	Clear	100	56 x 120	6
W211755	Amber	100	56 x 120	6



Packaging

- Packaged in convenience packs with caps attached
- Convenience bulk packs provide larger quantities with or without caps attached for high use items or facilities with centralized stockrooms

Tamper Evident Seal / HAZCOM Label

- HAZCOM label allows for ID of content and safety notification
- Labels provided in each case of bottles with the exception of bulk packs
- Tamper Evident Seal keeps bottle sealed, protecting contents from accidental misuse

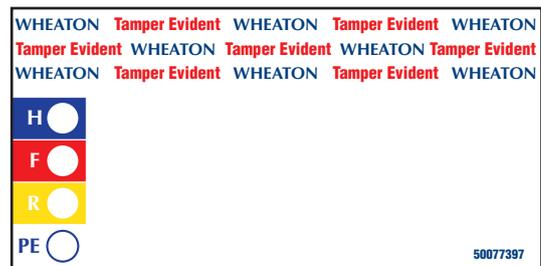

Not actual label size



General Purpose Glass Bottles

- Bottles manufactured from soda-lime glass that conforms to USP Type III requirements
- Available in clear glass or amber glass for light sensitive samples
- Narrow mouth bottles are ideal for liquids
- Wide mouth bottles are ideal for dry and viscous samples
- Valumetric™ bottles are for measuring while you sample
- White polypropylene or black phenolic screw caps
- Screw caps are pre-attached to the containers or are available separately
- Choice of cap liners: PTFE faced foamed polyethylene liner, poly-vinyl liner, rubber liner, PTFE faced rubber, or PE cone liner
- Tamper Evident Seal / HAZCOM Label provided in each case of bottles with the exception of bulk packs

Cap Liner Specifications

Material	Description	Applications
Pulp / Poly-Vinyl	One mil poly-vinyl film bonded to one mil HDPE on a #30 white pulp paper backing. Superior to plain pulp paper because it provides an excellent moisture barrier.	General purpose: Suitable for wide range of applications. Chemical resistance: Good for mild acids, alkalis, solvents, alcohols, oils and aqueous products. Poor for active hydrocarbons and bleaches.
PTFE Faced Foamed Polyethylene	PTFE faced foamed polyethylene liner that offers the excellent chemical resistance of PTFE with the compressibility and sealing properties of polyethylene foam.	Typical applications: analytical lab samples, high purity chemicals, strong acids, solvents. Excellent for environmental samples, pharmaceuticals and diagnostic reagents.
PE Cone	Manufactured from polyethylene (LDPE). The unique cone design provides a wedge type seal that not only seals across the top but also across the inside diameter.	This liner is stress crack resistant and offers superior torque retention and excellent sealing characteristics. It is recommended that this liner be tested prior to use for leak seal.
Styrene-Butadiene Rubber (14B)	The 14B white rubber lining material consists of homogeneous sulfur cured styrene-butadiene rubber. FDA Status complies with 21CFR 177.26, "Rubber articles intended for repeated use."	Excellent properties of resilience, resistant to moisture vapor. Satisfactory for most moderate chemicals. Not good for oils, strong acids and hydrocarbons. Autoclavable.
PTFE Faced Rubber	The white rubber / 0.005" PTFE liner consists of virign PTFE bonded to the white sulfur cured styrene-butadiene rubber. Complies with the FDA 21CFR 177.1550.	Designed for the ultimate in product safety. PTFE provides totally inert inner seal and surface facing the sample or product. Autoclavable.

AC Round Bottle

- Clear, USP Type III soda-lime glass
- Taller & narrower than Straight Sided Jars
- Available with caps attached or bulk packs without caps



Cat. No.	Capacity (oz)	Capacity (mL)*	Dia. x H (mm)	Cap Size	Cap Material	Cap Liner	Qty / Case
W217005	1	30	34 x 68	33-400	Without Cap	—	432
W216995	1	30	34 x 68	33-400	White Polypropylene	Poly-Vinyl	48
W217000	1	30	34 x 68	33-400	White Polypropylene	PTFE Faced Foamed Polyethylene	48
W217006	2	60	42 x 83	38-400	Without Cap	—	288
W216996	2	60	42 x 83	38-400	White Polypropylene	Poly-Vinyl	48
W217001	2	60	42 x 83	38-400	White Polypropylene	PTFE Faced Foamed Polyethylene	48
W217007	4	125	51 x 102	48-400	Without Cap	—	144
W216997	4	125	51 x 102	48-400	White Polypropylene	Poly-Vinyl	24
W217002	4	125	51 x 102	48-400	White Polypropylene	PTFE Faced Foamed Polyethylene	24
W217008	8	250	62 x 127	58-400	Without Cap	—	96
W216998	8	250	62 x 127	58-400	White Polypropylene	Poly-Vinyl	24
W217003	8	250	62 x 127	58-400	White Polypropylene	PTFE Faced Foamed Polyethylene	24
W217009	16	500	76 x 145	70-400	Without Cap	—	48
W216999	16	500	76 x 145	70-400	White Polypropylene	Poly-Vinyl	24
W217004	16	500	76 x 145	70-400	White Polypropylene	PTFE Faced Foamed Polyethylene	24

*Approximate capacity

Boston Round Bottle

- Clear or amber, USP Type III soda-lime glass
- Ideal for solvent, chemical or sample storage
- Available with caps attached or bulk packs without caps



Replacement Caps for AC Round Bottles

Cat. No.	Cap Size	Qty / Pack	Qty / Case
White Polypropylene / PTFE Faced Foamed Polyethylene Liner			
239236	33-400	72	144
239237	38-400	72	72
239240	48-400	72	72
239242	58-400	72	72
239244	70-400	24	48
White Polypropylene / Poly-Vinyl Liner			
239213	38-400	72	72
239216	48-400	72	72
239218	58-400	72	72
239220	70-400	24	48

Cat. No.	Color	Capacity (oz)	Capacity (mL)*	Dia. x H (mm)	Cap Size	Cap Material	Cap Liner	Qty / Case
W216830**	Clear	1	30	31 x 79	20-400	Without Cap	—	432
W216800	Clear	1	30	31 x 79	20-400	White Polypropylene	Poly-Vinyl	48
W216824	Clear	1	30	31 x 79	20-400	White Polypropylene	Poly-Vinyl	432
W216806	Clear	1	30	31 x 79	20-400	White Polypropylene	PTFE Faced Foamed Polyethylene	48
W216812	Clear	1	30	31 x 79	20-400	Black Phenolic	PE Cone	48
W216818**	Clear	1	30	31 x 79	20-400	Black Phenolic	Rubber	48
W216865**	Amber	1	30	31 x 79	20-400	Without Cap	—	432
W216836	Amber	1	30	31 x 79	20-400	White Polypropylene	Poly-Vinyl	48
W216859	Amber	1	30	31 x 79	20-400	White Polypropylene	Poly-Vinyl	432
W216842	Amber	1	30	31 x 79	20-400	White Polypropylene	PTFE Faced Foamed Polyethylene	48
W216848	Amber	1	30	31 x 79	20-400	Black Phenolic	PE Cone	48
W216854**	Amber	1	30	31 x 79	20-400	Black Phenolic	Rubber	48
W216831**	Clear	2	60	39 x 94	20-400	Without Cap	—	288
W216807	Clear	2	60	39 x 94	20-400	White Polypropylene	PTFE Faced Foamed Polyethylene	24
W216813	Clear	2	60	39 x 94	20-400	Black Phenolic	PE Cone	24
W216819**	Clear	2	60	39 x 94	20-400	Black Phenolic	Rubber	24
W216866**	Amber	2	60	39 x 94	20-400	Without Cap	—	288
W216837	Amber	2	60	39 x 94	20-400	White Polypropylene	Poly-Vinyl	24
W216860	Amber	2	60	39 x 94	20-400	White Polypropylene	Poly-Vinyl	288
W216843	Amber	2	60	39 x 94	20-400	White Polypropylene	PTFE Faced Foamed Polyethylene	24
W216849	Amber	2	60	39 x 94	20-400	Black Phenolic	PE Cone	24
W216854**	Amber	2	60	39 x 94	20-400	Black Phenolic	Rubber	24

Cat. No.	Color	Capacity (oz)	Capacity (mL)*	Dia. x H (mm)	Cap Size	Cap Material	Cap Liner	Qty / Case
W216832**	Clear	4	125	48 x 112	22-400	Without Cap	—	160
W216802	Clear	4	125	48 x 112	22-400	White Polypropylene	Poly-Vinyl	24
W216826	Clear	4	125	48 x 112	22-400	White Polypropylene	Poly-Vinyl	160
W216808	Clear	4	125	48 x 112	22-400	White Polypropylene	PTFE Faced Foamed Polyethylene	24
W216814	Clear	4	125	48 x 112	22-400	Black Phenolic	PE Cone	24
W216820**	Clear	4	125	48 x 112	22-400	Black Phenolic	Rubber	24
W216867**	Amber	4	125	48 x 112	22-400	Without Cap	—	160
W216838	Amber	4	125	48 x 112	22-400	White Polypropylene	Poly-Vinyl	24
W216861	Amber	4	125	48 x 112	22-400	White Polypropylene	Poly-Vinyl	160
W216844	Amber	4	125	48 x 112	22-400	White Polypropylene	PTFE Faced Foamed Polyethylene	24
W216850	Amber	4	125	48 x 112	22-400	Black Phenolic	PE Cone	24
W216855**	Amber	4	125	48 x 112	22-400	Black Phenolic	Rubber	24
W216833**	Clear	8	250	60 x 136	24-400	Without Cap	—	108
W216803	Clear	8	250	60 x 136	24-400	White Polypropylene	Poly-Vinyl	12
W216827	Clear	8	250	60 x 136	24-400	White Polypropylene	Poly-Vinyl	108
W216809	Clear	8	250	60 x 136	24-400	White Polypropylene	PTFE Faced Foamed Polyethylene	12
W216815	Clear	8	250	60 x 136	24-400	Black Phenolic	PE Cone	12
W216821**	Clear	8	250	60 x 136	24-400	Black Phenolic	Rubber	12
W216868**	Amber	8	250	60 x 136	24-400	Without Cap	—	108
W216839	Amber	8	250	60 x 136	24-400	White Polypropylene	Poly-Vinyl	12
W216862	Amber	8	250	60 x 136	24-400	White Polypropylene	Poly-Vinyl	108
W216845	Amber	8	250	60 x 136	24-400	White Polypropylene	PTFE Faced Foamed Polyethylene	12
W216851	Amber	8	250	60 x 136	24-400	Black Phenolic	PE Cone	12
W216856**	Amber	8	250	60 x 136	24-400	Black Phenolic	Rubber	12
W216834**	Clear	16	500	75 x 168	28-400	Without Cap	—	60
W216804	Clear	16	500	75 x 168	28-400	White Polypropylene	Poly-Vinyl	12
W216810	Clear	16	500	75 x 168	28-400	White Polypropylene	PTFE Faced Foamed Polyethylene	12
W216828	Clear	16	500	75 x 168	28-400	White Polypropylene	Poly-Vinyl	60
W216816	Clear	16	500	75 x 168	28-400	Black Phenolic	PE Cone	12
W216822**	Clear	16	500	75 x 168	28-400	Black Phenolic	Rubber	12
W216869**	Amber	16	500	75 x 168	28-400	Without Cap	—	60
W216840	Amber	16	500	75 x 168	28-400	White Polypropylene	Poly-Vinyl	12
W216846	Amber	16	500	75 x 168	28-400	White Polypropylene	PTFE Faced Foamed Polyethylene	12
W216852	Amber	16	500	75 x 168	28-400	Black Phenolic	PE Cone	12
W216857**	Amber	16	500	75 x 168	28-400	Black Phenolic	Rubber	12
W216835**	Clear	32	1000	94 x 206	33-400	Without Cap	—	12
W216805	Clear	32	1000	94 x 206	33-400	White Polypropylene	Poly-Vinyl	12
W216829	Clear	32	1000	94 x 206	33-400	White Polypropylene	Poly-Vinyl	12
W216811	Clear	32	1000	94 x 206	33-400	White Polypropylene	PTFE Faced Foamed Polyethylene	12
W216817	Clear	32	1000	94 x 206	33-400	Black Phenolic	PE Cone	12
W216823**	Clear	32	1000	94 x 206	33-400	Black Phenolic	Rubber	12
W216870**	Amber	32	1000	94 x 206	33-400	Without Cap	—	30
W216841	Amber	32	1000	94 x 206	33-400	White Polypropylene	Poly-Vinyl	12
W216864	Amber	32	1000	94 x 206	33-400	White Polypropylene	Poly-Vinyl	30
W216847	Amber	32	1000	94 x 206	33-400	White Polypropylene	PTFE Faced Foamed Polyethylene	12
W216853	Amber	32	1000	94 x 206	33-400	Black Phenolic	PE Cone	12
W216858**	Amber	32	1000	94 x 206	33-400	Black Phenolic	Rubber	12

*Approximate capacity **Autoclavable

Replacement Caps for Boston Round Bottles

Cat. No.	Cap Size	Qty / Pack	Qty / Case
Black Phenolic with Rubber Liner			
W239298	20-400	72	144
W239299	22-400	72	144
W239300	24-400	72	144
W239301	28-400	72	144
W239302	33-400	72	144
Black Phenolic / PE Cone Liner			
239253	20-400	72	144
239255	22-400	72	144
239257	24-400	72	144
239259	28-400	72	144
239260	33-400	72	144

Cat. No.	Cap Size	Qty / Pack	Qty / Case
White Polypropylene / PTFE Faced Foamed Polyethylene Liner			
239229	20-400	72	144
239231	22-400	72	144
239233	24-400	72	144
239235	28-400	72	144
239236	33-400	72	144
White Polypropylene / Poly-Vinyl Liner			
239207	22-400	72	144
239209	24-400	72	144
239211	28-400	72	144

French Square Bottle

- Clear USP Type III soda-lime glass
- Ideal for solvent, chemical or sample storage
- Square shape maximizes storage space
- Available with caps attached or bulk packs without caps



Cat. No.	Color	Capacity (oz)	Capacity (mL)*	Dia. x H (mm)	Cap Size	Cap Material	Cap Liner	Qty / Case
W216871	Clear	0.5	15	27 x 66	20-400	White Polypropylene	Poly-Vinyl	48
W217883	Clear	0.5	15	27 x 66	20-400	White Polypropylene	Poly-Vinyl	576
W216877	Clear	0.5	15	27 x 66	20-400	White Polypropylene	PTFE Faced Foamed Polyethylene	48
W216889	Clear	0.5	15	27 x 66	20-400	Black Phenolic	PE Cone	48
W216883**	Clear	0.5	15	27 x 66	20-400	Black Phenolic	Rubber	48
W216898**	Clear	1	30	31 x 72	24-400	Without Cap	—	280
W216893	Clear	1	30	31 x 72	24-400	White Polypropylene	Poly-Vinyl	280
W216872	Clear	1	30	31 x 72	24-400	White Polypropylene	Poly-Vinyl	48
W216878	Clear	1	30	31 x 72	24-400	White Polypropylene	PTFE Faced Foamed Polyethylene	48
W216890	Clear	1	30	31 x 72	24-400	Black Phenolic	PE Cone	48
W216884**	Clear	1	30	31 x 72	24-400	Black Phenolic	Rubber	48
W216899**	Clear	2	60	39 x 87	28-400	Without Cap	—	240
W216894	Clear	2	60	39 x 87	28-400	White Polypropylene	Poly-Vinyl	240
W216873	Clear	2	60	39 x 87	28-400	White Polypropylene	Poly-Vinyl	48
W216879	Clear	2	60	39 x 87	28-400	White Polypropylene	PTFE Faced Foamed Polyethylene	48
W216891	Clear	2	60	39 x 87	28-400	Black Phenolic	PE Cone	48
W216885**	Clear	2	60	39 x 87	28-400	Black Phenolic	Rubber	48
W216900**	Clear	4	125	45 x 111	33-400	Without Cap	—	120
W216895	Clear	4	125	45 x 111	33-400	White Polypropylene	Poly-Vinyl	120
W216874	Clear	4	125	45 x 111	33-400	White Polypropylene	Poly-Vinyl	24
W216880	Clear	4	125	45 x 111	33-400	White Polypropylene	PTFE Faced Foamed Polyethylene	24
W216892	Clear	4	125	45 x 111	33-400	Black Phenolic	PE Cone	24
W216886**	Clear	4	125	45 x 111	33-400	Black Phenolic	Rubber	24
W216901**	Clear	8	250	56 x 137	43-400	Without Cap	—	84
W216896	Clear	8	250	56 x 137	43-400	White Polypropylene	Poly-Vinyl	84
W216875	Clear	8	250	56 x 137	43-400	White Polypropylene	Poly-Vinyl	24
W216881	Clear	8	250	56 x 137	43-400	White Polypropylene	PTFE Faced Foamed Polyethylene	24
W216887**	Clear	8	250	56 x 137	43-400	Black Phenolic	Rubber	24
W216902**	Clear	16	500	68 x 167	48-400	Without Cap	—	40
W216897	Clear	16	500	68 x 167	48-400	White Polypropylene	Poly-Vinyl	40
W216876	Clear	16	500	68 x 167	48-400	White Polypropylene	Poly-Vinyl	24
W216882	Clear	16	500	68 x 167	48-400	White Polypropylene	PTFE Faced Foamed Polyethylene	24
W216888**	Clear	16	500	68 x 167	48-400	Black Phenolic	Rubber	24
W217882**	Clear	32	1000	85 x 207	58-400	Without Cap	—	24
W217881	Clear	32	1000	85 x 207	58-400	White Polypropylene	PE Cone	12
W217884	Clear	32	1000	85 x 207	58-400	White Polypropylene	Poly-Vinyl	12
W217880**	Clear	32	1000	85 x 207	58-400	Black Phenolic	Rubber	12

*Approximate capacity **Autoclavable

Replacement Caps for French Square Bottles

Cat. No.	Cap Size	Qty / Pack	Qty / Case
Black Phenolic with Rubber Liner			
W239298	20-400	72	144
W239300	24-400	72	144
W239301	28-400	72	144
W239302	33-400	72	144
W239304	43-400	72	72
W239306	48-400	72	72
W239308	58-400	72	72
Black Phenolic / PE Cone Liner			
239253	20-400	72	144
239257	24-400	72	144
239259	28-400	72	144
239260	33-400	72	144

Cat. No.	Cap Size	Qty / Pack	Qty / Case
White Polypropylene / PTFE Faced Foamed Polyethylene Liner			
239229	20-400	72	144
239233	24-400	72	144
239235	28-400	72	144
239236	33-400	72	144
239238	43-400	72	72
239240	48-400	72	72
239242	58-400	72	72
White Polypropylene with Poly-Vinyl Liner			
239209	24-400	72	144
239211	28-400	72	144
239214	43-400	72	72
239216	48-400	72	72
239218	58-400	72	72

Standard Wide Mouth Bottle, Clear

- Clear, Type III soda-lime glass
- Largest bottles available
- Ideal for general, small to large volume storage
- Available with caps attached or without caps



Cat. No.	Capacity (oz)	Capacity (mL)*	Dia. x H (mm)	Cap Size	Cap Material	Cap Liner	Qty / Case
W216934**	4	125	52 x 84	48-400	Without Cap	—	24
W216924	4	125	52 x 84	48-400	White Polypropylene	Poly-Vinyl	24
W216929	4	125	52 x 84	48-400	White Polypropylene	PTFE Faced Foamed Polyethylene	24
W216935**	8	250	63 x 110	58-400	Without Cap	—	24
W216925	8	250	63 x 110	58-400	White Polypropylene	Poly-Vinyl	24
W216930	8	250	63 x 110	58-400	White Polypropylene	PTFE Faced Foamed Polyethylene	24
W216936**	16	500	79 x 133	63-400	Without Cap	—	24
W216926	16	500	79 x 133	63-400	White Polypropylene	Poly-Vinyl	24
W216931	16	500	79 x 133	63-400	White Polypropylene	PTFE Faced Foamed Polyethylene	24
W217923	32	1000	98 x 174	89-400	Without Cap	—	12
W217922	32	1000	98 x 174	89-400	White Polypropylene	PTFE Faced Foamed Polyethylene	12
W217924	32	1000	98 x 174	89-400	White Polypropylene	Poly-Vinyl	12
W216937**	65	2000	122 x 213	83-400	Without Cap	—	6
W216927	65	2000	122 x 213	83-400	White Polypropylene	Poly-Vinyl	6
W216932	65	2000	122 x 213	83-400	White Polypropylene	PTFE Faced Foamed Polyethylene	6
W216938**	130	4000	157 x 256	89-400	Without Cap	—	4
W216928	130	4000	157 x 256	89-400	White Polypropylene	Poly-Vinyl	4
W216933	130	4000	157 x 256	89-400	White Polypropylene	PTFE Faced Foamed Polyethylene	4

*Approximate capacity **Autoclavable

Replacement Caps for Standard Wide Mouth Bottles

Cat. No.	Cap Size	Qty / Pack	Qty / Case
White Polypropylene / PTFE Faced Foamed Polyethylene Liner			
239240	48-400	72	72
239242	58-400	72	72
239243	63-400	24	48
239246	89-400	24	48

Cat. No.	Cap Size	Qty / Pack	Qty / Case
White Polypropylene / Poly-Vinyl Liner			
239216	48-400	72	72
239218	58-400	72	72
239222	89-400	24	48

Straight Sided Jar

- Clear or Amber, USP Type III soda-lime glass
- Wide mouth design is great for large solid samples
- Walls allow for complete removal of contents
- Ideal for soil sampling and environmental applications
- Available with caps attached or bulk packs without caps



Cat. No.	Color	Capacity (oz)	Capacity (mL)*	Dia. x H (mm)	Cap Size	Cap Material	Cap Liner	Qty / Case
W217905	Clear	1	30	44 x 44	43-400	White Polypropylene	PTFE Faced Foamed Polyethylene	48
W217906	Clear	1	30	44 x 44	43-400	White Polypropylene	Poly-Vinyl	48
W216919**	Clear	2	60	55 x 48	53-400	Without Cap	—	144
W216903	Clear	2	60	55 x 48	53-400	White Polypropylene	Poly-Vinyl	24
W216908	Clear	2	60	55 x 48	53-400	White Polypropylene	PTFE Faced Foamed Polyethylene	24
W216914	Clear	2	60	55 x 48	53-400	White Polypropylene	Poly-Vinyl	144
W216920**	Clear	4	125	62 x 73	58-400	Without Cap	—	24
W216904	Clear	4	125	62 x 73	58-400	White Polypropylene	Poly-Vinyl	24
W216909	Clear	4	125	62 x 73	58-400	White Polypropylene	PTFE Faced Foamed Polyethylene	24
W216913**	Clear	4	125	62 x 73	58-400	Black Phenolic	Rubber	24
W217907	Amber	4	125	62 x 73	58-400	White Polypropylene	PTFE Faced Foamed Polyethylene	24
W216921**	Clear	8	250	75 x 94	70-400	Without Cap	—	24
W216905	Clear	8	250	75 x 94	70-400	White Polypropylene	Poly-Vinyl	12
W216910	Clear	8	250	75 x 94	70-400	White Polypropylene	PTFE Faced Foamed Polyethylene	12
W217908	Amber	8	250	75 x 94	70-400	White Polypropylene	PTFE Faced Foamed Polyethylene	12
W216922**	Clear	16	500	91 x 95	89-400	Without Cap	—	12
W216906	Clear	16	500	91 x 95	89-400	White Polypropylene	Poly-Vinyl	12
W216911	Clear	16	500	91 x 95	89-400	White Polypropylene	PTFE Foamed Faced Polyethylene	12
W216923**	Clear	32	1000	95 x 170	89-400	Without Cap	—	12
W216907	Clear	32	1000	95 x 170	89-400	White Polypropylene	Poly-Vinyl	12
W216912	Clear	32	1000	95 x 170	89-400	White Polypropylene	PTFE Foamed Faced Polyethylene	12

*Approximate capacity **Autoclavable

Replacement Caps for Straight Sided Jars

Cat. No.	Cap Size	Qty / Pack	Qty / Case
White Polypropylene / PTFE Faced Foamed Polyethylene Liner			
239241	53-400	72	72
239242	58-400	72	72
239244	70-400	24	48
239246	89-400	24	48

Cat. No.	Cap Size	Qty / Pack	Qty / Case
White Polypropylene / Poly-Vinyl Liner			
239217	53-400	72	72
239218	58-400	72	72
239220	70-400	24	48
239222	89-400	24	48

Testing Jars

- Made from USP Type III clear soda-lime glass
- Wide mouth ideal for solids
- Pre-attached white polypropylene caps with choice of liner



Cat. No.	Capacity (mL)	Dia x H (mm)	Cap Liner	Qty/Case
W216650	60	45 x 95	Poly-Vinyl	6
W216651	60	45 x 95	PTFE Faced Foamed PE	6

Replacement Caps for Testing Jars

Cat. No.	Cap Size	Qty / Pack	Qty / Case
White Polypropylene / Poly-Vinyl Liner			
239214	43-400	72	72
White Polypropylene / PTFE Faced Foamed Polyethylene Liner			
239238	43-400	72	72

Valumetric™ Graduated Bottle, Clear

- Clear, USP Type III soda-lime glass
- Easy removal of contents
- Graduated in mL and ounces
- Ideal for general storage
- Available with caps attached or bulk packs without caps



Cat.No.	Capacity (oz)	Capacity (mL)*	Dia. x H (mm)	Cap Size	Cap Material	Cap Liner	Qty / Case
W216989**	1	30	34 x 68	33-400	Without Cap	—	432
W216966	1	30	34 x 68	33-400	White Polypropylene	Poly-Vinyl	48
W216971	1	30	34 x 68	33-400	White Polypropylene	PTFE Faced Foamed Polyethylene	48
W216976	1	30	34 x 68	33-400	Black Phenolic	PE Cone	48
W216978**	1	30	34 x 68	33-400	Black Phenolic	Rubber	48
W216982	1	30	34 x 68	33-400	White Polypropylene	Poly-Vinyl	432
W216987	1	30	34 x 68	33-400	Black Phenolic	PE Cone	432
W216990**	2	60	43 x 84	38-400	Without Cap	—	288
W216967	2	60	43 x 84	38-400	White Polypropylene	Poly-Vinyl	48
W216972	2	60	43 x 84	38-400	White Polypropylene	PTFE Faced Foamed Polyethylene	48
W216977	2	60	43 x 84	38-400	Black Phenolic	PE Cone	48
W216979**	2	60	43 x 84	38-400	Black Phenolic	Rubber	48
W216983	2	60	43 x 84	38-400	White Polypropylene	Poly-Vinyl	288
W216988	2	60	43 x 84	38-400	Black Phenolic	PE Cone	288
W217970	2	60	43 x 84	38-400	Black Phenolic	Foil	48
W216991**	4	125	52 x 103	48-400	Without Cap	—	144
W216968	4	125	52 x 103	48-400	White Polypropylene	Poly-Vinyl	24
W216973	4	125	52 x 103	48-400	White Polypropylene	PTFE Faced Foamed Polyethylene	24
W216980**	4	125	52 x 103	48-400	Black Phenolic	Rubber	24
W216984	4	125	52 x 103	48-400	White Polypropylene	Poly-Vinyl	144
W217971	4	125	52 x 103	48-400	Black Phenolic	Foil	24
W216992**	8	250	64 x 129	58-400	Without Cap	—	96
W216969	8	250	64 x 129	58-400	White Polypropylene	Poly-Vinyl	24
W216974	8	250	64 x 129	58-400	White Polypropylene	PTFE Faced Foamed Polyethylene	24
W216981**	8	250	64 x 129	58-400	Black Phenolic	Rubber	24
W216985	8	250	64 x 129	58-400	White Polypropylene	Poly-Vinyl	96
W217972	8	250	64 x 129	58-400	Black Phenolic	Foil	24
W216993**	16	500	78 x 147	70-400	Without Cap	—	48
W216970	16	500	78 x 147	70-400	White Polypropylene	Poly-Vinyl	24
W216975	16	500	78 x 147	70-400	White Polypropylene	PTFE Faced Foamed Polyethylene	24
W216986	16	500	78 x 147	70-400	White Polypropylene	Poly-Vinyl	48
W217973**	16	500	78 x 147	70-400	Black Phenolic	Rubber	24

*Approximate capacity **Autoclavable

Replacement Caps for Valumetric™ Graduated Bottles

Cat. No.	Cap Size	Qty/Pack	Qty/Case
Black Phenolic / PE Cone Liner			
239260	33-400	72	144
W240541	38-400	48	576
Black Phenolic / Rubber Liner			
W239302	33-400	144	144
W239303	38-400	72	72
W239306	48-400	72	72
W239308	58-400	72	72

Cat. No.	Cap Size	Qty/Pack	Qty/Case
White Polypropylene / PTFE Faced Foamed Polyethylene Liner			
239236	33-400	72	144
239237	38-400	72	72
239240	48-400	72	72
239242	58-400	72	72
239244	70-400	24	48
White Polypropylene / Poly-Vinyl Liner			
239213	38-400	72	72
239216	48-400	72	72
239218	58-400	72	72
239220	70-400	24	48

Wide Mouth Packer, Amber

- Amber, USP Type III soda-lime glass
- Ideal for storage of light sensitive samples or dry powders
- Easy removal of contents



Cat. No.	Capacity (oz)	Capacity (mL)*	Dia. x H (mm)	Cap Size	Cap Material	Cap Liner	Qty / Case
W216960**	1	30	37 x 65	28-400	Without Cap	—	432
W216939	1	30	37 x 65	28-400	White Polypropylene	Poly-Vinyl	24
W216945	1	30	37 x 65	28-400	White Polypropylene	PTFE Faced Foamed Polyethylene	24
W216951	1	30	37 x 65	28-400	Black Phenolic	PE Cone	24
W216954	1	30	37 x 65	28-400	White Polypropylene	Poly-Vinyl	432
W216961**	2	60	44 x 75	33-400	Without Cap	—	216
W216940	2	60	44 x 75	33-400	White Polypropylene	Poly-Vinyl	24
W216946	2	60	44 x 75	33-400	White Polypropylene	PTFE Faced Foamed Polyethylene	24
W216952	2	60	44 x 75	33-400	Black Phenolic	PE Cone	24
W216955	2	60	44 x 75	33-400	White Polypropylene	Poly-Vinyl	216
W216962**	4	125	54 x 95	38-400	Without Cap	—	180
W216941	4	125	54 x 95	38-400	White Polypropylene	Poly-Vinyl	24
W216947	4	125	54 x 95	38-400	White Polypropylene	PTFE Faced Foamed Polyethylene	24
W216953	4	125	54 x 95	38-400	Black Phenolic	PE Cone	24
W216956	4	125	54 x 95	38-400	White Polypropylene	Poly-Vinyl	180
W216963**	8	250	66 x 119	45-400	Without Cap	—	84
W216942	8	250	66 x 119	45-400	White Polypropylene	Poly-Vinyl	24
W216948	8	250	66 x 119	45-400	White Polypropylene	PTFE Faced Foamed Polyethylene	24
W216957	8	250	66 x 119	45-400	White Polypropylene	Poly-Vinyl	84
W216964**	16	500	80 x 146	53-400	Without Cap	—	60
W216943	16	500	80 x 146	53-400	White Polypropylene	Poly-Vinyl	12
W216949	16	500	80 x 146	53-400	White Polypropylene	PTFE Faced Foamed Polyethylene	12
W216958	16	500	80 x 146	53-400	White Polypropylene	Poly-Vinyl	60
W216965**	32	1000	99 x 178	53-400	Without Cap	—	36
W216944	32	1000	99 x 178	53-400	White Polypropylene	Poly-Vinyl	12
W216950	32	1000	99 x 178	53-400	White Polypropylene	PTFE Faced Foamed Polyethylene	12
W216959	32	1000	99 x 178	53-400	White Polypropylene	Poly-Vinyl	36
W217931	42	1250	108 x 192	70-400	White Polypropylene	PTFE Faced Foamed Polyethylene	6
W217932	85	2500	142 x 241	70-400	White Polypropylene	PTFE Faced Foamed Polyethylene	12

*Approximate capacity **Autoclavable

Replacement Caps for Wide Mouth Packers

Cat. No.	Cap Size	Qty / Pack	Qty / Case
Black Phenolic / PE Cone Liner			
239259	28-400	72	144
239260	33-400	72	144
W240541	38-400	48	576

White Polypropylene / PTFE Faced Foamed Polyethylene Liner

239235	28-400	72	144
239236	33-400	72	144
239237	38-400	72	72
239239	45-400	72	72
239241	53-400	72	72
239244	70-400	24	48

Cat. No.	Cap Size	Qty / Pack	Qty / Case
White Polypropylene / Poly-Vinyl Liner			
239211	28-400	72	144
239213	38-400	72	72
239217	53-400	72	72



Safety Coated Bottle

- Platisol coating for safety
- Made from clear or amber soda-lime glass that conforms to USP Type III requirements
- Available with or without caps
- 4, 8, 16 and 32oz Boston Round style
- 80oz and 4L with jug handle



Cat No.	Color	Approx Size (oz)	Cap On***	Cap Off***	Cap Size	Cap Material/Cap Liner	Qty/Case
W217950	Amber	4	52 x 117	52 x 114	22-400	Poly-Vinyl Lined White Polypropylene Cap	24
W217953	Amber	4	52 x 117	52 x 114	22-400	PE Cone LDPE Black Phenolic Cap	24
W217956	Amber	4	52 x 117	52 x 114	22-400	PTFE Faced Foamed PE White Polypropylene Cap	24
220724**	Clear	8	64 x 142	64 x 139	24-400	Without Cap	48
220924**	Amber	8	64 x 142	64 x 139	24-400	Without Cap	48
W217852	Clear	8	64 x 142	64 x 139	24-400	Poly-Vinyl Lined White Polypropylene Cap	12
W217854	Clear	8	64 x 142	64 x 139	24-400	PTFE Faced Foamed PE White Polypropylene Cap	12
W217954	Amber	8	64 x 142	64 x 139	24-400	PE Cone LDPE Black Phenolic Cap	12
W217957	Amber	8	64 x 142	64 x 139	24-400	PTFE Faced Foamed PE White Polypropylene Cap	12
220725**	Clear	16	78 x 174	78 x 171	28-400	Without Cap	24
220925**	Amber	16	78 x 174	78 x 171	28-400	Without Cap	24
W217851	Clear	16	78 x 174	78 x 171	28-400	PE Cone LDPE Black Phenolic Cap	12
W217951	Amber	16	78 x 174	78 x 171	28-400	Poly-Vinyl Lined White Polypropylene Cap	12
W217958	Amber	16	78 x 174	78 x 171	28-400	PTFE Faced Foamed PE White Polypropylene Cap	12
220755	Clear	16	78 x 174	78 x 171	28-400	PE Cone LDPE Black Phenolic Cap	24
220955	Amber	16	78 x 174	78 x 171	28-400	PE Cone LDPE Black Phenolic Cap	24
W217855	Clear	16	78 x 174	78 x 171	28-400	PTFE Faced Foamed PE White Polypropylene Cap	12
W217955	Amber	16	78 x 174	78 x 171	28-400	PE Cone LDPE Black Phenolic Cap	12
220745	Clear	16	78 x 174	78 x 171	28-400	Polyethylene LDPE lined Black Phenolic Cap	24
220945	Amber	16	78 x 174	78 x 171	28-400	Polyethylene LDPE lined Black Phenolic Cap	24
220775**	Clear	16	78 x 174	78 x 171	28-400	PTFE Rubber Lined Black Phenolic Cap	24
220975**	Amber	16	78 x 174	78 x 171	28-400	PTFE Rubber Lined Black Phenolic Cap	24
220735	Clear	16	78 x 174	78 x 171	28-400	Aluminum Foil Lined Black Phenolic Cap	24
220935	Amber	16	78 x 174	78 x 171	28-400	Aluminum Foil Lined Black Phenolic Cap	24
220726**	Clear	32	98 x 212	98 x 209	33-400	Without Cap	12
W217850**	Clear	32	98 x 212	98 x 209	33-400	Without Cap	30
220926**	Amber	32	98 x 212	98 x 209	33-400	Without Cap	12
W217853	Clear	32	98 x 212	98 x 209	33-400	Poly-Vinyl Lined White Polypropylene Cap	12
W217952	Amber	32	98 x 212	98 x 209	33-400	Poly-Vinyl Lined White Polypropylene Cap	12
W217959	Amber	32	98 x 212	98 x 209	33-400	PTFE Faced Foamed PE White Polypropylene Cap	12
220756	Clear	32	98 x 212	98 x 209	33-400	PE Cone LDPE Black Phenolic Cap	12
220956	Amber	32	98 x 212	98 x 209	33-400	PE Cone LDPE Black Phenolic Cap	12
220746	Clear	32	98 x 212	98 x 209	33-400	Polyethylene LDPE lined Black Phenolic Cap	12
220946	Amber	32	98 x 212	98 x 209	33-400	Polyethylene LDPE lined Black Phenolic Cap	12
220776**	Clear	32	98 x 212	98 x 209	33-400	PTFE Rubber Lined Black Phenolic Cap	12
220976**	Amber	32	98 x 212	98 x 209	33-400	PTFE Rubber Lined Black Phenolic Cap	12
W217856	Clear	32	98 x 212	98 x 209	33-400	PTFE Faced Foamed PE White Polypropylene Cap	12
220736	Clear	32	98 x 212	98 x 209	33-400	Aluminum Foil Lined Black Phenolic Cap	12
220936	Amber	32	98 x 212	98 x 209	33-400	Aluminum Foil Lined Black Phenolic Cap	12
220728**	Clear	80*	135 x 295	135 x 291	38-439	Without Cap	6
220738	Clear	80*	135 x 295	135 x 291	38-439	Aluminum Foil Lined Black Phenolic Cap	6
W220930**	Amber	4L*	158 x 343	158 x 340	38-439	Without Cap	4
W220950	Amber	4L*	158 x 343	158 x 340	38-439	Polyethylene LDPE lined Black Phenolic Cap	4
W220985**	Amber	4L*	158 x 343	158 x 340	38-439	PTFE Rubber Lined Black Phenolic Cap	4
W220940	Amber	4L*	158 x 343	158 x 340	38-439	Aluminum Foil Lined Black Phenolic Cap	4

*Manufactured with jug handle **Autoclavable ***Dia x H (mm)

Safety Coated Jar

- Platisol coating for safety
- Made from clear or amber soda-lime glass that conforms to USP Type III requirements
- Wide mouth for use with solid samples
- Available with or without caps



Cat No.	Color	Approx Size (oz)	Cap On*	Cap Off*	Cap Size	Cap Material/Cap Liner	Qty/Case
216637**	Clear	8	77 x 94	77 x 91	70-400	Without Cap	12
216627	Clear	8	77 x 94	77 x 91	70-400	With Poly-Vinyl Lined Black Phenolic Cap	12
W217925	Clear	8	77 x 94	77 x 91	70-400	PTFE Faced Foamed PE White Polypropylene Cap	12
W217960	Amber	8	69 x 125	69 x 122	45-400	PTFE Faced Foamed PE White Polypropylene Cap	24
W217963	Amber	8	69 x 125	69 x 122	45-400	Poly-Vinyl Lined White Polypropylene Cap	24
216639**	Clear	16	80 x 151	80 x 148	70-400	Without Cap	12
216629	Clear	16	80 x 151	80 x 148	70-400	With Poly-Vinyl Lined Black Phenolic Cap	12
W217926	Clear	16	80 x 151	80 x 148	70-400	PTFE Faced Foamed PE White Polypropylene Cap	12
W217928	Clear	16	80 x 151	80 x 148	70-400	Poly-Vinyl Lined White Polypropylene Cap	12
W217961	Amber	16	85 x 152	85 x 149	53-400	PTFE Faced Foamed PE White Polypropylene Cap	12
W217964	Amber	16	85 x 152	85 x 149	53-400	Poly-Vinyl Lined White Polypropylene Cap	12
W216641**	Clear	32	100 x 175	100 x 172	89-400	Without Cap	12
W216631	Clear	32	100 x 175	100 x 172	89-400	With Poly-Vinyl Lined Black Phenolic Cap	12
W217921	Clear	32	100 x 175	100 x 172	89-400	Poly-Vinyl Lined White Polypropylene Cap	12
W217927	Clear	32	100 x 175	100 x 172	89-400	PTFE Faced Foamed PE White Polypropylene Cap	12
W217962	Amber	32	103 x 183	103 x 180	53-400	PTFE Faced Foamed PE White Polypropylene Cap	12
W217965	Amber	32	103 x 183	103 x 180	53-400	Poly-Vinyl Lined White Polypropylene Cap	12

* Dia x H (mm) **Autoclavable

Screw Neck Diagnostic Bottle

- Alternative to serum bottles and vials
- Can be used for lyophilization
- Fits with I-Loc™ closure or screw cap with thin flange stopper
- Superior chemical resistance
- Manufactured from WHEATON 400 borosilicate glass that conforms to USP Type I requirements
- Autoclavable



Cat. No.	Color	Capacity (mL)	Dia. x H (mm)	Cap Size	Qty / Case
219371	Amber	10	25 x 61	20-400	480

I-Loc™ Closure

- For use with Screw Neck Diagnostic Bottles
- Advantages of an aluminum seal with the convenience of a screw cap
- Polypropylene screw cap with gray bromobutyl / 50 stopper
- Autoclavable



Cat. No.	Color	Cap Size	Qty / Case
240676-01	Black	20-400	100
240676-02	White	20-400	100
240676-03	Red	20-400	100
240676-04	Blue	20-400	100
240676-05	Yellow	20-400	100

Serum Bottle

- Ideal for long and short term sample storage, lyophilization and vaccine / injectable drug containers
- Fits most lyophilization applications
- Borosilicate glass conforms to USP Type I requirements
- Clear bottles manufactured from WHEATON 400 borosilicate molded glass that conforms to USP Type I requirements
- Amber bottles manufactured from WHEATON 500 borosilicate glass that conforms to USP Type I requirements
- Shrink-wrapped partitioned modules reduce breakage

Cat. No.	Color	Size (mL)	Mouth ID x OD (mm)*	Dia. x H (mm)	Fits Rack	Qty / Case
W223712	Clear	2	7 x 13	15.6 x 36	868810	288
223738	Clear	5	13 x 20	23 x 47	868805	288
223760	Amber	5	13 x 20	23 x 47	868805	288
223739	Clear	10	13 x 20	25 x 54	868806	288
223761	Amber	10	13 x 20	25 x 54	868806	288
223742	Clear	20	13 x 20	32 x 58	—	288
223762	Amber	20	13 x 20	32 x 58	—	288
223743	Clear	30	13 x 20	37 x 63	—	288
223763	Amber	30	13 x 20	37 x 63	—	288
223745	Clear	50	13 x 20	43 x 73	—	288
223764	Amber	50	13 x 20	43 x 73	—	288
223746	Clear	60	13 x 20	41 x 91	—	144
223747	Clear	100	13 x 20	52 x 95	—	144
223766	Amber	100	13 x 20	52 x 95	—	144
223748	Clear	125	13 x 20	54 x 107	—	144

*Note: Select aluminum seal and stopper size by using the mouth OD dimension of the bottle or vial

Screw Caps for Screw Neck Diagnostic Bottles



- Polypropylene screw caps in 5 colors
- Use with 224100-203 or W224100-190 thin flange stopper
- Autoclavable

Cat. No.	Cap Size	Cap Style	Color	Autoclavable	Qty / Case
240706-01	20-400	Solid Top	Black	Yes	300
240706-02	20-400	Solid Top	White	Yes	300
240706-04	20-400	Solid Top	Blue	Yes	300
240706-05	20-400	Solid Top	Yellow	Yes	300
240716-01	20-400	Open-Top	Black	Yes	300
240716-02	20-400	Open-Top	White	Yes	300
240716-03	20-400	Open-Top	Red	Yes	300
240716-04	20-400	Open-Top	Blue	Yes	300
240716-05	20-400	Open-Top	Yellow	Yes	300

Stopper, Thin Flange

- Use with screw caps for Screw Neck Diagnostic Bottles
- Autoclavable



Cat. No.	Description	Qty / Case
224100-203	20mm 3-Leg Lyophilization Gray Chlorobutyl / 55	300
W224100-190	20mm Thin Flange Snap-On Gray Chlorobutyl / 49	300

Serum Bottle, PVC Dropper Tip

- Create a dropper bottle using a serum bottle with 20mm OD finish
- Dropper tip is made from PVC with PE cap
- Dispenses 40µL drop using distilled water
- Economical way to convert a glass serum bottle to a dropping bottle



Cat. No.	Description	Dia. x H (mm)	Qty / Case
224080	PVC Dropper Tip	23 x 44	100



Serum Tubing Vial

- Clear vials are manufactured from low extractable borosilicate glass that conforms to USP Type I and ASTM E 438 Type I, Class A requirements
- The amber vials are manufactured from low extractable borosilicate glass that conforms to USP Type I requirements
- Special design adds strength for freeze-drying applications
- Shrink-wrapped modules reduce particulate contamination



Cat. No.	Color	Size (mL)	Mouth ID x OD (mm)	Dia. x H (mm)	Fits Rack	Qty / Case
223683	Clear	2	7 x 13	15 x 32	868804	144
223693	Amber	2	7 x 13	15 x 32	868804	144
223684	Clear	3	7 x 13	17 x 38	868810	144
223685	Clear	5	13 x 20	22 x 40	868805	144
223695	Amber	5	13 x 20	22 x 40	868805	144
223686	Clear	10	13 x 20	24 x 50	—	144
223696	Amber	10	13 x 20	24 x 50	—	144
223687	Clear	20	13 x 20	30.5 x 58	—	120

Serum Bottle, Graduated

- Raised graduations indicate approximate capacities in milliliters
- Accepts standard stoppers and seals
- Manufactured from WHEATON 400 borosilicate glass that conforms to USP Type I requirements



Cat. No.	Size (mL)	Mouth ID x OD (mm)	Dia. x H (mm)	Qty / Case
223950	250	15 x 30	60 x 158	35
223952	500	15 x 30	75 x 190	24

Tamper Evident Safety Cap



- For use with Uni-Dose® Bottles and Vials
- Caps have Pulp / PVDC / PE Liner

Cat. No.	Description	For Mouth OD (mm)	Qty / Case
W224198	Cap for Uni-Dose® Bottle and Vial	28.5	2500
W224199	Cap with "For Oral Use" Imprint	28.5	5000
224316	Crimper	28.5	1

Snap Cap Sample Bottle

- Pre-attached low density polyethylene snap caps
- Ideal for collecting, storing, and exhibiting samples in the lab or field
- Packaged in corrugated trays with partitions
- Manufactured from WHEATON 800 soda-lime clear glass that conforms to USP Type III requirements



Cat. No.	Size (mL)	Dia. x H (mm)	Cap Size (mm)	Qty / Case
225532	4	23 x 27	22	144
225534	8	22 x 39	22	144
225535	12	22 x 51	22	144
225536	16	30 x 40	30	144
225538	24	30 x 52	30	144
225543	30	37 x 50	34	72
225544	60	45 x 60	45	72
225546	120	50 x 95	45	72



Replacement Snap Caps

Cat. No.	Cap Size (mm)	Qty / Case
242612	22	200
242615	30	200
242616	34	200
242619	45	200

Uni-Dose® Bottle & Vial



- Available in amber glass or amber PET (Polyethylene Terephthalate)
- Mouth OD 28.5mm
- Use with WHEATON tamper evident safety cap
- Large labeling surface for easy product identification
- Manufactured from WHEATON 900 soda-lime amber glass that conforms to USP Type III requirements
- Alternative to glass and cost less to ship
- Use the 224316 Crimper to secure the tamper-evident safety caps (Cat. No. W224198 or W224199) to the bottle or vial

Cat. No.	Size (mL)	Dia. x H (mm)	Trays/Case	Qty / Case
Amber Glass Bottle				
226732	15	32 x 42	5	500
226733	30	36 x 58	5	500
Amber PET Vial				
226773	30	34 x 55	—	300



An Alternative to Glass

Plastic Bottles

Plastic containers have been developed for a variety of applications across many different industries over the years. There are many different types of polymers used in the creation of these containers to help fill the demands for the various applications. Polymers offer a variety of properties, each having different levels of importance with different users depending on the application. Some users may have flexibility within their product formula or filling process and therefore focus on economical containers while others may need containers that are stronger, autoclavable, transparent, sterilized, etc., therefore requiring more specifications. DWK Life Sciences can help with polymer selection through comprehension of the customer's product, goals, and adaptability. Several questions should be posed to gather this understanding.

Some examples include:

What is the container size and physical design: Narrow mouth vs. wide mouth, tall vs. short, etc.?

Must the package be transparent, translucent, opaque or colored for either marketing or light protection?

Are there specific shipment and storage conditions such as refrigeration, freezing, exclusion of light, etc.?

Are there governmental regulations pertaining to the product?

How is the product going to be dispensed by the user?

Have any tests been run in plastic? Was it unsuccessful and why? What type of plastics?

Many things govern polymer suitability for package use. These include:

- Permeation / Barrier
- Sorption Characteristics
- Chemical Resistance
- Stress Crack Resistance
- Rigidity / Flexibility
- Impact Resistance
- Sterilizability
- Recyclability
- Temperature Resistance

Bottles, Plastic

- > Diagnostic.....31
- > Dispensing.....30
- > Dropping 29-30
- > General Purpose.....28
- > Leak Resistant27
- > Media.....31
- > PETG Media.....32
- > Resin Identification Codes.....32
- > Serum.....31
- > Spray.....30

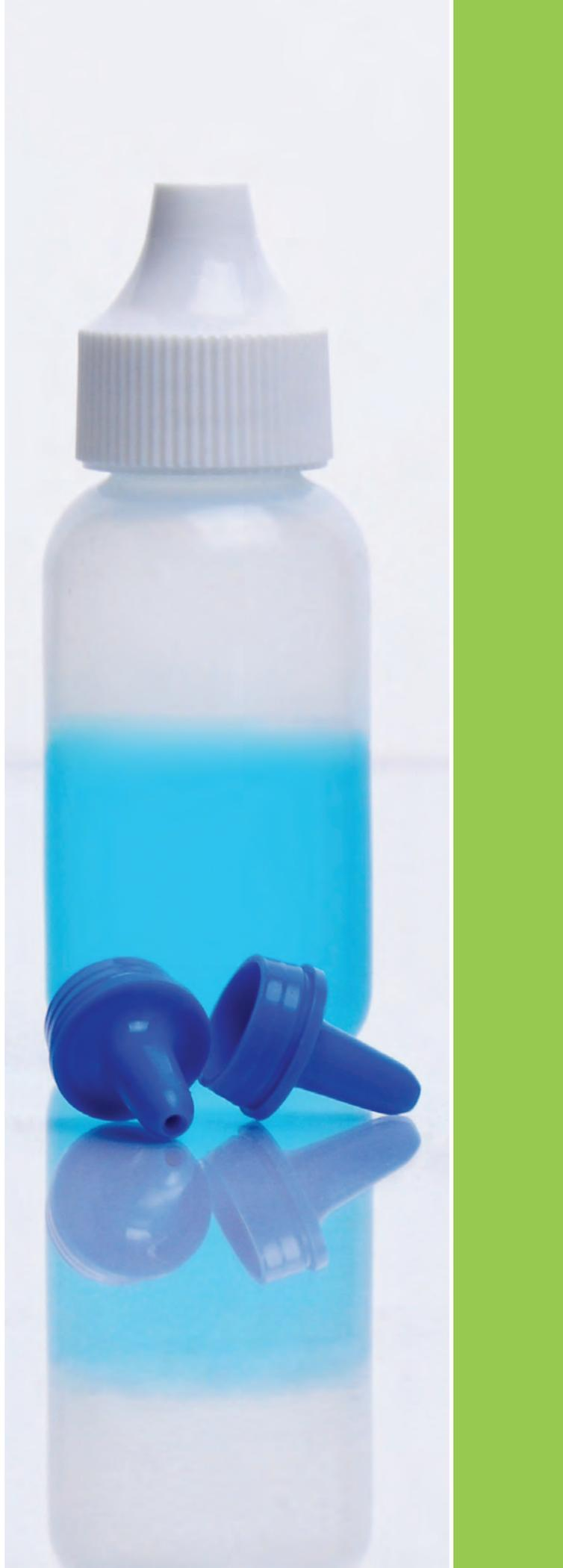

Leak Resistant Bottle

- High or low density polyethylene (HDPE/LDPE), or polypropylene (PP)
- Amber or natural color
- Available in narrow or wide mouth



- Superior double seal closure for leak resistance
- No-drip pour lip for safe and clean pouring
- Polypropylene cap attached
- See page 47 for colored screw caps



Cat. No.	Size (oz)*	Size (mL)	Material	Color	Mouth Opening	Dia. x H (mm)	Cap Size	Qty / Pack	Qty / Case
209041	.1	4	HDPE	Natural	Narrow	16 x 38	13-425	12	72
209121	.1	4	HDPE	Amber	Narrow	16 x 38	13-425	12	72
209161	.1	4	PP**	Natural	Narrow	16 x 38	13-425	12	72
208923	.3	8	LDPE	Natural	Narrow	25 x 43	20-410	12	72
209043	.3	8	HDPE	Natural	Narrow	25 x 43	20-410	12	72
209123	.3	8	HDPE	Amber	Narrow	25 x 43	20-410	12	72
209163	.3	8	PP**	Natural	Narrow	25 x 43	20-410	12	72
208924	.5	15	LDPE	Natural	Narrow	25 x 56	20-410	12	72
209044	.5	15	HDPE	Natural	Narrow	25 x 56	20-410	12	72
209124	.5	15	HDPE	Amber	Narrow	25 x 56	20-410	12	72
209164	.5	15	PP**	Natural	Narrow	25 x 56	20-410	12	72
208925	1	30	LDPE	Natural	Narrow	32 x 69	20-410	12	72
209045	1	30	HDPE	Natural	Narrow	32 x 69	20-410	12	72
209125	1	30	HDPE	Amber	Narrow	32 x 69	20-410	12	72
209165	1	30	PP**	Natural	Narrow	32 x 69	20-410	12	72
209425	1	30	LDPE	Natural	Wide	33 x 69	28-410	12	72
209545	1	30	HDPE	Natural	Wide	33 x 69	28-410	12	72
209625	1	30	HDPE	Amber	Wide	33 x 69	28-410	12	72
209665	1	30	PP**	Natural	Wide	33 x 69	28-410	12	72
208926	2	60	LDPE	Natural	Narrow	39 x 84	20-410	12	72
209046	2	60	HDPE	Natural	Narrow	39 x 84	20-410	12	72
209126	2	60	HDPE	Amber	Narrow	39 x 84	20-410	12	72
209166	2	60	PP**	Natural	Narrow	39 x 84	20-410	12	72
209546	2	60	HDPE	Natural	Wide	39 x 88	28-410	12	72
209626	2	60	HDPE	Amber	Wide	39 x 88	28-410	12	72
209666	2	60	PP**	Natural	Wide	39 x 88	28-410	12	72
208927	4	125	LDPE	Natural	Narrow	50 x 101	24-410	12	72
209047	4	125	HDPE	Natural	Narrow	50 x 101	24-410	12	72
209127	4	125	HDPE	Amber	Narrow	50 x 101	24-410	12	72
209167	4	125	PP**	Natural	Narrow	50 x 101	24-410	12	72
209427	4	125	LDPE	Natural	Wide	51 x 98	38-410	12	72
209547	4	125	HDPE	Natural	Wide	51 x 98	38-410	12	72
209627	4	125	HDPE	Amber	Wide	51 x 98	38-410	12	72
209667	4	125	PP**	Natural	Wide	51 x 98	38-410	12	72
208928	8	250	LDPE	Natural	Narrow	61 x 129	24-410	12	72
209048	8	250	HDPE	Natural	Narrow	61 x 129	24-410	12	72
209128	8	250	HDPE	Amber	Narrow	61 x 129	24-410	12	72
209168	8	250	PP**	Natural	Narrow	61 x 129	24-410	12	72
209428	8	250	LDPE	Natural	Wide	61 x 125	43-410	12	72
209548	8	250	HDPE	Natural	Wide	61 x 125	43-410	12	72
209628	8	250	HDPE	Amber	Wide	61 x 125	43-410	12	72
209668	8	250	PP**	Natural	Wide	61 x 125	43-410	12	72
209049	16	500	HDPE	Natural	Narrow	72 x 171	28-410	12	48
209129	16	500	HDPE	Amber	Narrow	72 x 171	28-410	12	48
209169	16	500	PP**	Natural	Narrow	72 x 171	28-410	12	48
209549	16	500	HDPE	Natural	Wide	72 x 164	53-410	12	48
209629	16	500	HDPE	Amber	Wide	72 x 164	53-410	12	48
209669	16	500	PP**	Natural	Wide	72 x 164	53-410	12	48
209050	32	1000	HDPE	Natural	Narrow	91 x 210	38-430	6	24
209130	32	1000	HDPE	Amber	Narrow	91 x 210	38-430	6	24
209170	32	1000	PP**	Natural	Narrow	91 x 210	38-430	6	24
209550	32	1000	HDPE	Natural	Wide	91 x 199	63-415	12	48
209630	32	1000	HDPE	Amber	Wide	91 x 199	63-415	12	48

* Approximate capacity **Autoclavable

Cylinder Round Bottle, HDPE, Natural & White

- High Density Polyethylene, natural and *white color
- Good chemical resistance
- Narrow mouth ideal for liquids
- Pre-attached white polypropylene screw cap with foamed polyethylene liner



Cat. No.	Size (oz)	Size (mL)**	Dia x H (mm)	Cap Size	Qty/Pack	Qty/Case
221153	1	30	27 x 78	20-410	12	72
221163*	1	30	27 x 78	20-410	12	72
221154	2	60	35 x 98	20-410	12	72
221164*	2	60	35 x 98	20-410	12	72
W221180	8	250	52 x 160	24-410	—	230
W221181	16	500	64 x 203	24-410	—	24
W221182	16	500	64 x 203	24-410	—	180
W221183	32	1000	81 x 243	28-400	—	77

*White HDPE **Approximate capacity

Jug, HDPE

- High Density Polyethylene, natural color
- Good chemical resistance
- Narrow mouth ideal for liquids
- Pre-attached white polypropylene screw cap with polyvinyl liner



Cat. No.	Size (oz)	Cross Section x H (mm)	Cap Size	Qty/Case
W222340	64	123 x 253	38-400	40
W222341	128	137 x 295	38-400	4
222333	128	137 x 295	38-400	4

Round Bottle, LDPE, Translucent

- Low Density Polyethylene, translucent color
- LDPE is very flexible with high impact strength
- Excellent for mild and strong buffers, good chemical resistance
- Narrow mouth ideal for liquids
- Pre-attached white polypropylene screw cap with foamed polyethylene liner



Cat. No.	Size (mL)	Dia x H (mm)	Cap Size	Qty/Pack	Qty/Case
221140	7	19 x 63	15-415	12	144
221142	15	25 x 78	15-415	12	144
221143	30	33 x 73	20-410	12	72
221144	60	39 x 88	20-410	12	72
W221145	125	47 x 115	20-410	12	72

Wide Mouth Blake Packer, HDPE, Natural

- High Density Polyethylene, natural color
- Good chemical resistance
- Blake design maximizes storage space
- Wide mouth ideal for solids
- Pre-attached white polypropylene screw cap with foamed polyethylene liner



Cat. No.	Size (oz)	Size (mL)*	Dia x H (mm)	Cap Size	Qty/Case
209683	4	120	52 x 43 x 99	38-400	72
W218814	8	250	72 x 51 x 121	43-400	48
209685	16	500	78 x 65 x 154	43-400	48
209686	32	1000	98 x 81 x 197	53-400	24
W218820	40	1200	110 x 81 x 193	53-400	6

*Approximate capacity

Wide Mouth Round Packer, HDPE, Natural

- High Density Polyethylene, natural color
- Good chemical resistance
- Wide mouth ideal for solids
- Pre-attached white polypropylene screw cap with foamed polyethylene liner



Cat. No.	Size (oz)	Size (mL)*	Dia x H (mm)	Cap Size	Qty/Case
W218821	1	30	38 x 59	28-400	48
209672	2	60	39 x 77	33-400	72
209673	4	120	50 x 88	38-400	72
W218822	4	120	49 x 88	38-400	500
209674	8	250	68 x 105	53-400	72
209675	16	500	77 x 142	53-400	48
209676	32	1000	97 x 180	53-400	24
W218823	65	2000	152 x 168	89-400	75

*Approximate capacity

Wide Mouth Container, Polypropylene

- Durable container with good chemical resistance
- Pre-attached white polypropylene screw cap unlined or with foamed polyethylene liner
- Polypropylene container with linerless cap is autoclavable



Cat. No.	Size (mL)	Dia x H (mm)	Cap Size	Cap Liner	Qty/Case
W209900	30	39 x 41	43-400	No liner	72
W209906	30	39 x 41	43-400	Polyethylene	72
W209901	60	49 x 46	53-400	No liner	48
W209907	60	49 x 46	53-400	Polyethylene	48
W209902	125	53 x 68	58-400	No liner	36
W209908	125	53 x 68	58-400	Polyethylene	36
W209903	250	84 x 64	89-400	No liner	36
W209909	250	84 x 64	89-400	Polyethylene	36
W209904	500	85 x 99	89-400	No liner	24
W209910	500	85 x 99	89-400	Polyethylene	24
W209905	1000	116 x 97	120-400	No liner	24
W209911	1000	116 x 97	120-400	Polyethylene	24

Wide Mouth Container, Polystyrene

- Clear polystyrene offers clarity of glass and safety of plastic
- Good resistance to inorganic chemicals
- Pre-attached white polypropylene screw cap with foamed polyethylene liner



Cat. No.	Size (mL)	Dia x H (mm)	Cap Size	Qty/Case
W209912	30	39 x 41	43-400	72
W209913	60	49 x 46	53-400	48
W209914	125	53 x 68	58-400	36
W209915	250	84 x 64	89-400	36
W209916	500	85 x 99	89-400	24
W209917	1000	116 x 97	120-400	24

Wide Mouth Container, HDPE

- High Density Polyethylene, natural color
- Good chemical resistance
- Largest container available: 2000 to 3840mL size
- Pre-attached white polypropylene screw cap with foamed polyethylene liner



Cat. No.	Size (mL)	Dia x H (mm)	Cap Size	Qty/Case
W209677	2000	155 x 173	89-400	6
W209679	3840	156 x 246	89-400	4

Dropping Bottle Only, Natural & White

- Bottle made of natural or white LDPE (Low Density Polyethylene)
- White LDPE bottle helps protect UV light sensitive samples
- Packaged in cases of 100, 1000



Color	Dia. x H (mm)	Cap Size	Cat. No. 100 / Case	Cat. No. 1,000 / Case
3mL				
White	14 x 39	8-425	W242831	W242831-A
Natural	14 x 39	8-425	W242821	W242821-A
6mL				
White	18 x 42	13-425	W242832	W242832-A
Natural	18 x 42	13-425	W242822	W242822-A
7mL				
White	19 x 51	15-415	W242833	W242833-A
Natural	19 x 51	15-415	W242823	W242823-A
10mL				
White	25 x 46	15-415	W242834	W242834-A
Natural	25 x 46	15-415	W242824	W242824-A
15mL				
White	25 x 66	15-415	W242835	W242835-A
Natural	25 x 66	15-415	W242825	W242825-A
30mL				
White	32 x 70	20-410	W242836	W242836-A
Natural	32 x 70	20-410	W242826	W242826-A
60mL				
White	39 x 85	20-410	W242837	—
Natural	39 x 85	20-410	W242827	—
120mL				
White	47 x 108	20-410	W242839	—
Natural	47 x 108	20-410	W242829	—

Dropping Bottle, Natural, with Tip & Cap

- Tip dispenses a stream of liquid or non-controlled drop
- Bottle made of LDPE (low density polyethylene)
- Bottle is not autoclavable
- Dropper bottles, tips and caps are packaged separately



Cat. No.	Size (mL)	Dia. x H (mm)	Cap Size	Qty / Pack	Qty / Case
211602	6	18 x 58	13-425	12	144
211603	7	19 x 63	15-415	12	144
211604	15	25 x 78	15-415	12	144
211605	30	32 x 85	20-410	12	144
211606	60	39 x 101	20-410	12	144
W211607	125	47 x 125	20-410	6	72

Extended Controlled Dropper Tip



- Tip made of LDPE (low density polyethylene)
- Extended controlled dropper tip dispenses one drop at a time
- Average drop size is 44µL ±6µL
- Packaged in case of 100, 1000

Color	Cat. No.	Cat. No.
8mm Tip		
	100/Case	1,000/Case
Natural	242401-01	W242401-01-A
Pink	242401	W242401-A
Red	242402	W242402-A
Orange	242403	W242403-A
Blue	242404	W242404-A
Gray	242405	W242405-A
Green	242406	W242406-A
Purple	242407	W242407-A
Yellow	242408	W242408-A
White	242410	W242410-A
13mm Tip		
	100/Case	1,000/Case
Natural	242411-01	W242411-01-A
Pink	242411	W242411-A
Red	242412	W242412-A
Orange	242413	W242413-A
Blue	242414	W242414-A
Gray	242415	W242415-A
Green	242416	W242416-A
Purple	242417	W242417-A
Yellow	242418	W242418-A
White	242420	W242420-A
15mm Tip		
	100/Case	1,000/Case
Natural	242421-01	W242421-01-A
Pink	242421	W242421-A
Red	242422	W242422-A
Orange	242423	W242423-A
Blue	242424	W242424-A
Gray	242425	W242425-A
Green	242426	W242426-A
Purple	242427	W242427-A
Yellow	242428	W242428-A
White	242430	W242430-A
20mm Tip		
	100/Case	1,000/Case
Natural	242431-01	W242431-01-A
Pink	242431	W242431-A
Red	242432	W242432-A
Orange	242433	W242433-A
Blue	242434	W242434-A
Green	242436	W242436-A
Purple	242437	W242437-A
Yellow	242438	W242438-A
White	242440	W242440-A

Dropper Tip Cap



8-425



13-425



15-415



20-410

- Screw cap made of radiation grade polypropylene
- Variety of colors
- Packaged in case of 100, 1000

Color	Cat. No.	Cat. No.
Size 8-425	100/Case	1,000/Case
Natural	242501-01	W242501-01-A
Pink	242501	W242501-A
Red	242502	W242502-A
Orange	242503	W242503-A
Blue	242504	W242504-A
Gray	242505	W242505-A
Green	242506	W242506-A
Purple	242507	W242507-A
Yellow	242508	W242508-A
Brown	242509	W242509-A
White	242510	W242510-A
Size 13-425	100/Case	1,000/Case
Natural	242531-01	W242531-01-A
Pink	242531	W242531-A
Red	242532	W242532-A
Orange	242533	W242533-A
Blue	242534	W242534-A
Gray	242535	W242535-A
Green	242536	W242536-A
Purple	242537	W242537-A
Yellow	242538	W242538-A
White	242540	W242540-A
Size 15-415	100/Case	1,000/Case
Natural	242511-01	W242511-01-A
Pink	242511	W242511-A
Red	242512	W242512-A
Orange	242513	W242513-A
Blue	242514	W242514-A
Gray	242515	W242515-A
Green	242516	W242516-A
Purple	242517	W242517-A
Yellow	242518	W242518-A
Brown	242519	W242519-A
White	242520	W242520-A
Size 20-410	100/Case	1,000/Case
Natural	242521-01	W242521-01-A
Pink	242521	W242521-A
Red	242522	W242522-A
Orange	242523	W242523-A
Blue	242524	W242524-A
Gray	242525	W242525-A
Green	242526	W242526-A
Purple	242527	W242527-A
Yellow	242528	W242528-A
White	242530	W242530-A

Dropping Bottle, with Tip & Cap

- Bottle made of LDPE (Low Density Polyethylene)
- Extended controlled dropper tip dispenses one drop at a time
- Average drop size is 44 μ L \pm 6 μ L
- Radiation grade polypropylene screw caps and tips packaged separately
- Dropping bottles, natural tips and white caps are packaged separately



Cat. No.	Color	Size (mL)	Dia. x H (mm)	Cap Size	Qty/Pack	Qty/Case
211630	Natural	3	14 x 49	8-425	12	144
211620	White	3	14 x 49	8-425	12	144
211631	Natural	6	17 x 58	13-425	12	144
211621	White	6	17 x 58	13-425	12	144
211632	Natural	7	19 x 63	15-415	12	144
211622	White	7	19 x 63	15-415	12	144
211633	Natural	15	25 x 78	15-415	12	144
211623	White	15	25 x 78	15-415	12	144
211634	Natural	30	32 x 85	20-410	12	144
211624	White	30	32 x 85	20-410	12	144
211635	Natural	60	39 x 101	20-410	12	144
211625	White	60	39 x 101	20-410	12	144
W211636	Natural	125	47 x 125	20-410	6	72
W211626	White	125	47 x 125	20-410	6	72

Dispensing Bottle, LDPE

- Made from low density polyethylene
- Translucent color
- Very flexible with high impact strength
- Excellent for mild and strong buffers, good chemical resistance
- Raise the spout to dispense contents and depress spout to seal bottle



Cat. No.	Size (mL)	Dia. x H (mm)	Cap Size	Qty/Pack	Qty/Case
211194	60	39 x 92	20-410	12	144
211195	125	43 x 130	20-410	12	72

Dropping Bottle in Vial File®

- Contains 40 - 3mL LDPE (Low Density Polyethylene) bottles
- Assembled with dropper tip and cap attached to bottle
- Average drop size is 44 μ L \pm 6 μ L
- Packaged in a reusable plastic case
- Extended controlled dropper tip dispenses one drop at a time
- Alphanumerical indexing of contents provides quick identification and location of samples



Cat. No.	Size (mL)	Dia. x H (mm)	Cap Size	Vials/File	Qty/Case
211641	3	14 x 49	8-425	40	1

Spray Bottle

- Bottle made of white LDPE (Low Density Polyethylene)
- Includes bottle, atomizer tip, dip tube and screw cap
- Screw cap made from polypropylene
- Packed in 12 shelf packs with 12 bottles each



Cat. No.	Size (mL)	Cross Section x H (mm)	Cap Size	Qty/Case
226433	20	20 x 38 x 83	15-415	144
226434	35	22 x 46 x 94	18-410	144
226436	60	27 x 53 x 108	18-410	144

PET Diagnostic Bottle

- Polyethylene Terephthalate, transparent
- Ideal for reagents and buffer solutions
- Clear and amber versions available
- Pre-attached white polypropylene screw cap with foamed polyethylene liner



Cat. No.	Color	Size (mL)	Qty / Pack	Qty / Case
W220000	Clear	5	20	100
W220003	Amber	5	20	100
W220001	Clear	10	20	100
W220004	Amber	10	20	100
W220002	Clear	20	20	100
W220005	Amber	20	20	100

Media Bottle, Sterile PET

- Lightweight
- Permanent in-mold graduations
- No-drip pour lip
- 20% headspace for additives
- Manufactured from polyethylene terephthalate tested superior for pH stability, temperature durability, cloning efficiency and cytotoxicity
- Pre-attached white polypropylene screw cap with foamed polyethylene liner, shrink-wrapped in trays



Cat. No.	Size (mL)	Grad. (mL)	Dim. (L x W x H)	Cap Size	Qty / Case
219975	125	25	53 x 53 x 99mm	33-430	48

PET Bottle, Transparent

- Polyethylene terephthalate, transparent
- PET offers clarity of glass with the safety of plastic
- Good alcohol and solvent barrier; not good for strong acids and bases
- Sterilizable through EtO and gamma radiation
- 120mL cylinder round style, smaller sizes have sloped shoulders
- Narrow mouth ideal for liquids
- Pre-attached white polypropylene screw cap with foamed polyethylene liner



Cat. No.	Size (mL)	Dia. x H (mm)	Cap Size	Qty / Pack	Qty / Case
221135	120	41 x 120	20-410	12	72

HDPE Oblong Bottles

- High density polyethylene, natural
- Good chemical resistance
- Wide mouth ideal for solids
- With or without** cap attached

Cat. No.	Size (oz)	Size (mL)*	L x W x H (mm)	Cap Size	Qty/Case
W218812	4	125	48 x 40 x 97	38-400	48
W218813	4	125	48 x 40 x 97	38-400	500
W218814	8	250	69 x 49 x 119	43-400	48
W218815	8	250	69 x 49 x 119	43-400	250
W218810**	16	500	76 x 63 x 152	43-400	160
W218816	16	500	76 x 63 x 152	43-400	24
W218817	16	500	76 x 63 x 152	43-400	168
W218811**	32	1000	96 x 79 x 172	53-400	116
W218818	32	1000	96 x 79 x 172	53-400	12
W218819	32	1000	96 x 79 x 172	53-400	116
W218820	42	1250	107 x 79 x 187	53-400	6

*Approximate capacity

Serum Bottle, Polypropylene (PP)

- Used extensively for diluent solutions
- Accepts rubber stoppers and aluminum seals
- Autoclavable at 121°C for 20 minutes



Cat. No.	Size (mL)	Mouth ID x OD (mm)	Dia. x H (mm)	Qty / Case
224007	3	7 x 13	17 x 38	500

Serum Bottle, HDPE

- Manufactured from high density polyethylene
- Widely used for animal health products and storage of non-medical products
- Accepts standard rubber stoppers and aluminum seals



Cat. No.	Size (mL)	Mouth ID x OD (mm)	Dia. x H (mm)	Qty / Case
224031	15	13 x 20	28 x 56	300
224033	30	13 x 20	32 x 67	200
224036	60	13 x 20	38 x 84	100
224037	120	13 x 20	47 x 103	100



PETG Media Bottles

- Polyethylene terephthalate glycol, transparent
- Available in range from 30mL to 2L
- Square/octagonal footprint for efficient use of storage space
- Excellent gas barrier properties, ensuring pH stability
- DNase- and RNase-Free
- Sterile, tamper-resistant seal ensures product integrity prior to use
- Comprised of resins that are free of animal-derived components
- Suitable for transport and storage, leak resistant
- Recommended temperature range +70°C to -40°C



with PETG Tamper Evident Cap	WPBGC2000S	WPBGC1000S	WPBGC0500S	WPBGC0250S	WPBGC0125S	WPBGC0060S	WPBGC0030S
with PETG Standard Cap	WPBGC2000SB	WPBGC1000SB	WPBGC0500SB	WPBGC0250SB	WPBGC0125SB	WPBGC0060SB	WPBGC0030SB
Size / Volume (mL)	2000	1000	500	250	125	60	30
Closure Size	53B	38-430	38-430	38-430	38-430	24-415	20-415
Units / Pack	6	12	12	24	24	24	24
Width / Diameter (mm)	115	92	73	59	54.4	40	38
Height (mm)	266	213	172	139	103.7	80	60
Height w/ Cap On (mm)	271.2	218.7	177.7	144.7	109.4	83.1	62.1

Resin Identification Codes

DWK Life Sciences follows the Society of Plastics Industry guidelines for marking plastic containers with the appropriate resin identification code numbers as shown below.

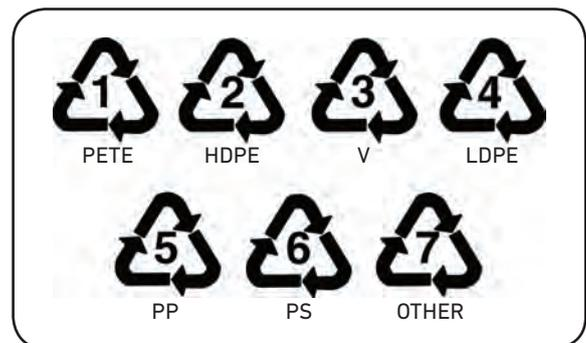

Plastic Resins

High Density Polyethylene (HDPE)

Flexible but more rigid than LDPE. Natural color is milky white, semi-translucent depending on density. Good impact strength and stress crack resistance. Good chemical resistance. Good vapor barrier but poor gas barrier. Sterilizable via ethylene oxide (EtO) or gamma radiation.



Sterilizable through EtO and gamma radiation. Good stress crack and impact resistance at room temperature and above.

Polypropylene (PP)

Rigid, solid, durable in container or cap forms. Opaque, natural grayish yellow in natural form. Excellent stress crack and impact resistance. Excellent moisture barrier, good oil and alcohol barrier, poor gas barrier properties. Good chemical resistance. Sterilizable with EtO or autoclaving.



Low Density Polyethylene (LDPE)

Very flexible, natural milky color, translucent with high impact strength. Excellent for mild and strong buffers, good chemical resistance. Good water vapor and alcohol barrier properties. Poor gas barrier, sterilizable with EtO or gamma radiation. Good stress crack and impact resistance.



Polystyrene (PS)

PS is a transparent, rigid and glasslike polymer. Good resistance to inorganic chemicals. Light and heat stable, biologically inert and non-toxic. Poor impact and stress crack resistance, poor barrier properties. EtO or gamma sterilizable.



Polyethylene Terephthalate (PET)

Semi-rigid to rigid depending on wall thickness. Natural color - clear and transparent. Good alcohol and solvent barrier; good gas and fair moisture barrier. Good to fair chemical barrier; not good for strong acids or bases. Good moldability.





Complete Your Package with the Right Closure

Caps & Closures

DWK Life Sciences completes your package with the right closure. We provide a wide variety of caps, seals and stoppers to ensure a perfect fit for your container. Our WHEATON® portfolio offers closures suited for a wide range of applications. Products include: aluminum seals, Microlink® caps, rubber stoppers and screw caps.

Aluminum Seal Styles

- Complete Tear-Off
- Open Top
- Center Disc Tear-Out
- Flip Cap
- Flip Cap Tear-Off
- Solid Top

Screw Closures

- Black Phenolic
- Polypropylene
- Urea

Rubber Stopper Styles

- 2-Leg Lyophilization
- 3-Leg Lyophilization
- Igloo
- Sleeve
- Straight Plug
- Snap On
- Thin Flange

Closure Liners

- Poly-Vinyl
- Foamed Polyethylene
- Polyethylene Cone
- PTFE / Silicone
- Metal Foil / Pulp
- Styrene-Butadiene Rubber (14B)
- Low Density Polyethylene (LDPE)

Caps & Closures

- > Aluminum Seals37-38
- > Crimpers & Decappers 39-40
- > Microlink® Cap.....45
- > Rubber Stoppers 35-36
- > Screw Caps 41-47
 - Black Phenolic Screw Caps41-42
 - GL45 Screw Caps.....46
 - Liquid Scintillation Vials Caps45
 - Polypropylene Screw Caps..... 43-44, 47
 - Septa for Open Top Caps45
- > Snap Caps.....47





Ultra Pure Stoppers



- Manufactured from an ultra pure bromobutyl formulation with extremely high chemical purity and low gas permeability
- Free of latex, nitrosamines and 2-MCBT (2-mercaptobenzothiazole)
- Compatible with applications such as Water for Injection (WFI) where rubber extractables can cause problems
- Complies with US, European and Japanese Pharmacopeias

Straight Plug Stoppers

- Grey bromobutyl/47
- Low level of extractables
- Autoclavable

Cat. No.	For Mouth ID x OD (mm)	Qty / Case
W224100-400	7 x 13	1000
W224100-405	13 x 20	1000

Lyophilization Stoppers

- Grey bromobutyl/46
- Available in 2-Leg, 3-Leg and Igloo styles
- Demonstrates a very low level of moisture adsorption
- Very low adsorption of the preservatives present in aqueous parenteral solutions
- Autoclavable

Cat. No.	For Mouth ID x OD (mm)	Qty / Case
2-Leg Lyophilization		
W224100-406	13 x 20	1000
3-Leg Lyophilization		
W224100-407	13 x 20	1000
Igloo Lyophilization		
W224100-402	7 x 13	1000
W224100-408	13 x 20	1000

Complete Coat Stoppers

- Grey bromobutyl/39
- Stoppers are completely coated with a fluorinated polymer
- Manufactured in a silicone-free environment
- PTFE like coating prevents reactions due to sample contact with rubber
- Autoclavable

Cat. No.	For Mouth ID x OD (mm)	Qty / Case
Straight Plug Stopper		
W224100-420	7 x 13	1000
W224100-421	13 x 20	1000

Rubber Stoppers



- Variety of styles, sizes and rubber formulations
- Manufactured from the highest quality raw materials
- Components manufactured to yield exceptional dimensional stability
- Straight plug stoppers provide maximum sealing for vials with straight-wall glass finish
- Snap-on style provides maximum sealing for vials with a blow-back glass finish
- Sleeve style stoppers feature a fold-over skirt for sealing in serum finish vials without a crimp closure
- Autoclavable

Cat. No.	For Mouth ID x OD (mm)	Style	Stopper Material	*Durometer	Shelf Pack	Qty / Case
224100-020	5 x 11	Sleeve	Natural Red Rubber	39	100	1000
224100-070	7 x 13	Straight Plug	Natural Red Rubber	40	100	1000
224100-072	7 x 13	Straight Plug	Gray Chlorobutyl-Isoprene Blend / FEP Faced	40	100	1000
W224100-093	7 x 13	2-Leg Lyophilization	Gray Chlorobutyl	50	100	1000
224100-060	7 x 13	Sleeve	Natural Red Rubber	39	100	1000
224100-080	7 x 13	Snap-On	Natural Red Rubber	40	100	1000
W224100-081	7 x 13	Snap-On	Gray Chlorobutyl	55	100	1000
224100-170	10 x 20	Straight Plug	Natural Red Rubber	40	100	1000
224100-160	10 x 20	Sleeve	Natural Red Rubber	39	100	1000
224100-172	13 x 20	Straight Plug	Natural Red Rubber	45	100	1000
W224100-173	13 x 20	Straight Plug	Gray Chlorobutyl	46	100	1000
224100-174	13 x 20	Straight Plug	Gray Chlorobutyl-Isoprene Blend	40	100	1000
224100-175	13 x 20	Straight Plug	Gray Chlorobutyl-Isoprene Blend / FEP Faced	40	—	1000
224100-177	13 x 20	Straight Plug	Black FKM	55	—	100
224100-178	13 x 20	Straight Plug	Silicone	55	100	1000
W224100-190	13 x 20	Snap-On – Thin Flange	Gray Chlorobutyl	49	100	300
224100-192	13 x 20	2-Leg Lyophilization	Gray Chlorobutyl-Isoprene Blend	50	100	1000
W224100-193	13 x 20	2-Leg Lyophilization	Gray Chlorobutyl	46	100	1000
W224100-202	13 x 20	3-Leg Lyophilization	Gray Chlorobutyl	46	100	1000
224100-203	13 x 20	3-Leg Lyophilization – Thin Flange	Gray Chlorobutyl	55	—	300
224100-161	13 x 20	Sleeve	Natural Red Rubber	39	100	1000
224100-180	13 x 20	Snap-On	Natural Red Rubber	45s	100	1000
W224100-181	13 x 20	Snap-On	Gray Chlorobutyl	46	100	1000
224100-330	15 x 30	Straight Plug	Natural Red Rubber	40s	100	1000
224100-331	15 x 30	Straight Plug	Gray Bromobutyl	50	100	1000
224100-320	15 x 30	Sleeve	Natural Red Rubber	39	100	1000
W224100-342	15 x 30	Snap-On	Gray Bromobutyl	52	100	1000
W224100-282	20 x 28	2-Leg Lyophilization	Gray Chlorobutyl	46	100	1000

*Durometer is a measure of the resistance of a material to indentation. The higher the number, the greater the resistance. The Shore A scale is used for soft elastomers. The term durometer is often used to refer to the measurement, as well as the instrument itself.

Lined Aluminum Seals

- Ideal closures for chromatography and other instrumentation applications
- Open top seal provides for filling or retrieving contents with a syringe



Open Top Lined Seal



Center Disc Tear-Out Lined Seal

Cat. No.	For Mouth OD (mm)	Seal Type	Seal Liner	Color	Qty / Pack	Qty / Case
224211-01	11	Open Top	PTFE / Red Rubber	Natural	100	1000
224211-05	11	Open Top	PTFE / Red Rubber	Blue	100	1000
224211-06	11	Open Top	PTFE / Red Rubber	Red	100	1000
224211-07	11	Open Top	PTFE / Red Rubber	Green	100	1000
224219-01	11	Open Top	PTFE / Silicone	Natural	100	1000
224219-05	11	Open Top	PTFE / Silicone	Blue	100	1000
224219-06	11	Open Top	PTFE / Silicone	Red	100	1000
224219-07	11	Open Top	PTFE / Silicone	Green	100	1000
224231-01	11	Open Top	PTFE / Silicone / PTFE	Natural	100	1000
224231-05	11	Open Top	PTFE / Silicone / PTFE	Blue	100	1000
224231-06	11	Open Top	PTFE / Silicone / PTFE	Red	100	1000
224231-07	11	Open Top	PTFE / Silicone / PTFE	Green	100	1000
224235-01	11	Open Top	PTFE / Gray Butyl	Natural	100	1000
224222-01	13	Center Disc Tear-Out	PTFE / Red Rubber	Natural	100	1000
224223-01	20	Center Disc Tear-Out	PTFE / Red Rubber	Natural	100	1000



Aluminum Seals (Unlined)



- Wide range of styles and sizes
- Color selection includes natural, red, blue and green
- Open top seals expose stopper for sample retrieval with a syringe
- Tear-off seal removes completely allowing content to pour from bottle
- Solid top seals are excellent for long-term storage of samples
- Flip cap seals provide tamper evidence

Cat. No.	For Mouth OD (mm)	Style	Color	Qty / Case
224176-01	11	Open Top	Natural	1000
224176-05	11	Open Top	Blue	1000
224176-06	11	Open Top	Red	1000
224176-07	11	Open Top	Green	1000
224189	11	Solid-Top	Natural	1000
224177-01	13	Open Top	Natural	1000
224177-05	13	Open Top	Blue	1000
224177-06	13	Open Top	Red	1000
224182-01	13	Center Disc Tear-Out	Natural	1000
224182-05	13	Center Disc Tear-Out	Blue	1000
224182-06	13	Center Disc Tear-Out	Red	1000
224182-07	13	Center Disc Tear-Out	Green	1000
224192-01	13	Complete Tear-Off	Natural	1000
224192-05	13	Complete Tear-Off	Blue	1000
224192-06	13	Complete Tear-Off	Red	1000
224192-07	13	Complete Tear-Off	Green	1000
224202	13	Flip Cap	Red	1000
W224207	13	Flip Cap Tear-Off	Red	1000
224178-01	20	Open Top	Natural	1000
224178-05	20	Open Top	Blue	1000
224178-06	20	Open Top	Red	1000
224178-07	20	Open Top	Green	1000
224183-01	20	Center Disc Tear-Out	Natural	1000
224183-05	20	Center Disc Tear-Out	Blue	1000
224183-06	20	Center Disc Tear-Out	Red	1000
224183-07	20	Center Disc Tear-Out	Green	1000
224191	20	Solid-Top	Natural	1000
224193-01	20	Complete Tear-Off	Natural	1000
224193-05	20	Complete Tear-Off	Blue	1000
224193-06	20	Complete Tear-Off	Red	1000
224193-07	20	Complete Tear-Off	Green	1000
224203	20	Flip Cap	Red	1000
W224205	20	Flip Cap	White	1000
224208	20	Flip Cap Tear-Off	Red	1000
224187-01	30	Center Disc Tear-Out	Natural	1000
224197-01	30	Complete Tear-Off	Natural	1000

Septa for Unlined Aluminum Seals



Cat. No.	For Mouth OD (mm)	Material	Qty / Case
224172	13	PTFE / Silicone	100
W224163	20	Silicone	1000
W224173	20	PTFE / Silicone	100
224168*	20	PTFE / Gray Butyl	100

224174	30	PTFE / Silicone	100
--------	----	-----------------	-----

*This item is a specially molded septa with a PTFE inset. The sealing surface of butyl and PTFE effect a more positive seal than plain PTFE faced septa.

Tamper Evident Safety Caps



- Use with WHEATON Uni-Dose® Bottles and Vials
- Three-piece Pulp / PVDC / PE lined aluminum caps have unique metal inserts
- Contents cannot be accessed without removing cap or leaving evidence of puncture or insert
- A metal tab with a rolled safety edge "perks up" to provide visual proof of tight seal
- Caps remove quickly and easily in one piece
- Catalog number W224199 is stamped inside "For Oral Use"
- Attach using WHEATON Crimper (Cat. No. 224316)

Cat. No.	For Mouth OD (mm)	Qty / Case
W224198	28.5	2500
W224199 (For Oral Use)	28.5	5000



Battery Powered Crimping Tool

- Powerful motor with a fast cycle
- Convenient controls on top of unit to adjust crimp
- Long lasting battery with Lithium Ion technology - up to 800 crimps per charge
- Advanced charging system including warning light when recharging is necessary
- Can be operated while charging
- Optional base and mounting kit

Cat. No.	Description	Size (mm)	Qty
W225708	Battery Powered Crimper	8	1
W225711	Battery Powered Crimper	11	1
W225712	Battery Powered Decapper	11	1
W225713	Battery Powered Crimper	13	1
W225714	Battery Powered Decapper	13	1
W225720	Battery Powered Crimper	20	1
W225721	Battery Powered Decapper	20	1
W225715	Battery Powered Flip Cap Crimper	13	1
W225722	Battery Powered Flip Cap Crimper	20	1

Automatic Crimping Tool Stand

Cat. No.	Description	Qty
W225701	Crimping Tool Stand	1

High Performance Crimping Tool

- Fastest and most powerful WHEATON crimping tool
- Strong enough for all steel and magnetic caps
- Designed with external power source and cord (no battery)
- Uses interchangeable jaw sets
- Stores up to 9 programs for different caps and seals
- Optional base and mounting kit

Cat. No.	Jaw(s) Included	Size (mm)	Qty
W225730-[]	—	—	1
W225731-[]	Crimper	20	1
W225732-[]	Crimper & Decapper	20	1
W225733-[]	Flip Cap Crimper & Decapper	20	1

High Performance Jaw Sets

Cat. No.	Jaw Type	Size (mm)	Qty
W225741	Crimper Jaw Set	8	1
W225751	Crimper Jaw Set	11	1
W225752	Decapper Jaw Set	11	1
W225761	Crimper Jaw Set	13	1
W225762	Decapper Jaw Set	13	1
W225763	Flip Cap Crimper Jaw Set	13	1
W225771	Crimper Jaw Set	20	1
W225772	Decapper Jaw Set	20	1
W225773	Flip Cap Crimper Jaw Set	20	1

	Plug Style
[A]	North American Cord, 120V
[B]	Japan Cord, 100V
[C]	Europe Cord, 230V
[D]	UK Cord, 230V
[F]	Australia / China, 240V
[G]	Italy / Chile, 230V
[J]	India Cord, 230V

*When ordering, please reference the letter corresponding to the correct electrical cord. Refer to page 146 for plug styles.

E-Z Crimper™

- Used to attach aluminum seals to bottles and vials with a crimp / serum finish
- Cushioned ergonomic handle reduces hand fatigue
- Labeled for quick size identification
- Polished crimping jaws provide consistent sealing



Cat. No.	Description	Qty / Case
W225300	Attaches 8mm Standard Aluminum Seals	1
W225301*	Attaches 11mm Standard Aluminum Seals	1
W225302	Attaches 13mm Standard Aluminum Seals	1
W225303	Attaches 20mm Standard Aluminum Seals	1

*The 11mm E-Z Crimper™ is supplied with a plunger insert to give the option of crimping the top of a vial creating an extra tight seal. We recommend this only for standard opening vials.

E-Z Decapper™



- Used to remove aluminum seals from bottles and vials with crimp / serum finish
- Cushioned ergonomic handle reduces hand fatigue
- Labeled for quick size identification
- Autoclavable

Cat. No.	Description	Qty / Case
W225350	Removes 8mm Standard Aluminum Seals	1
W225351	Removes 11mm Standard Aluminum Seals	1
W225352	Removes 13mm Standard Aluminum Seals	1
W225353	Removes 20mm Standard Aluminum Seals	1

Crimper / Decapper

- These crimpers are used for flip cap seals and for aluminum seals sizes 16.5, 28.5, and 30mm
- Not autoclavable



Cat. No.	Description	Qty / Case
224322	Crimper, attaches 13mm Flip Cap Seals	1
224321	Crimper, attaches 16.5mm Flip Cap Seals	1
224323	Crimper, attaches 20mm Flip Cap Seals	1
224316	Crimper, attaches 28.5mm Uni-Dose® Seals	1
224307	Crimper, attaches 30mm Seals	1
224357	Decapper, removes 30mm Seals	1

Plier Decapper

- An inexpensive and easy way to remove seals
- Made of steel with gray plastic-coated handles
- To remove a seal, simply secure the seal between the jaws, squeeze the handles and twist the seal



Cat. No.	Description	Qty / Case
224372	Removes 13mm Seals	1
224373	Removes 20mm Seals	1



Black Phenolic Screw Caps



14B Rubber Liner

- 14B Rubber lined caps feature a nontoxic white styrene-butadiene rubber liner ideal for cell culture work
- Aluminum foil faced pulp board liners can be used with organic solvents
- Use low density polyethylene (LDPE) lined caps with distilled water, analytical standards and reagents
- Open top caps with gray chlorobutyl / 50 septa are ideal for use with WHEATON media bottles
- Open top caps provide access with a syringe

Cat. No.	Cap Size	Cap Style	Cap Material	Color	Cap Liner	Autoclavable	Qty / Pack	Qty / Case
240206	8-425	Solid Top	Phenolic	Black	14B Rubber	Yes	—	1000
W240406	8-425	Solid Top	Phenolic	Black	PTFE / 14B Rubber	Yes	—	200
W240506	8-425	Open Top	Phenolic	Black	Linerless	No	—	200
240208	13-425	Solid Top	Phenolic	Black	14B Rubber	Yes	—	200
240408	13-425	Solid Top	Phenolic	Black	PTFE / 14B Rubber	Yes	—	200
W240820	13-425	Solid Top	Phenolic	Black	PTFE / 14B Rubber	Yes	—	250
W240821	13-425	Solid Top	Phenolic	Black	PTFE / 14B Rubber	Yes	250	1000
239249	13-425	Solid Top	Phenolic	Black	PE Cone	No	72	144
W240508	13-425	Open Top	Phenolic	Black	Linerless	Yes	—	200
240463	15-415	Solid Top	Phenolic	Black	PTFE / 14B Rubber	Yes	—	200
240209	15-425	Solid Top	Phenolic	Black	14B Rubber	Yes	—	200
240409	15-425	Solid Top	Phenolic	Black	PTFE / 14B Rubber	Yes	—	200
W240822	15-425	Solid Top	Phenolic	Black	PTFE / 14B Rubber	Yes	—	250
W240823	15-425	Solid Top	Phenolic	Black	PTFE / 14B Rubber	Yes	250	1000
239250	15-425	Solid Top	Phenolic	Black	PE Cone	No	72	144
W240509	15-425	Open Top	Phenolic	Black	Linerless	Yes	—	200
240215	18-400	Solid Top	Phenolic	Black	14B Rubber	Yes	—	500
240415	18-400	Solid Top	Phenolic	Black	PTFE / 14B Rubber	Yes	—	200
239251	18-400	Solid Top	Phenolic	Black	PE Cone	No	72	144
239451	18-400	Solid Top	Phenolic	Black	PE Cone	No	—	6,500
W240515	18-400	Open Top	Phenolic	Black	Linerless	Yes	—	200
240264	18-415	Solid Top	Phenolic	Black	14B Rubber	Yes	—	500
240414	18-415	Solid Top	Phenolic	Black	PTFE / 14B Rubber	Yes	—	200
W239298	20-400	Solid Top	Phenolic	Black	14B Rubber	Yes	72	144
240216	20-400	Solid Top	Phenolic	Black	14B Rubber	Yes	—	500
240416	20-400	Solid Top	Phenolic	Black	PTFE / 14B Rubber	Yes	—	100
239253	20-400	Solid Top	Phenolic	Black	PE Cone	No	72	144
W240516	20-400	Open Top	Phenolic	Black	Linerless	Yes	—	200
239853	22-350	Solid Top	Phenolic	Black	Linerless	Yes	—	500
W239299	22-400	Solid Top	Phenolic	Black	14B Rubber	Yes	72	144
W240824	22-400	Solid Top	Phenolic	Black	PTFE / 14B Rubber	Yes	—	100
W240825	22-400	Solid Top	Phenolic	Black	PTFE / 14B Rubber	Yes	100	500
239255	22-400	Solid Top	Phenolic	Black	PE Cone	No	72	144
W240517	22-400	Open Top	Phenolic	Black	Linerless	Yes	—	200



Metal Foil Liner



PE Cone Liner

Cat. No.	Cap Size	Cap Style	Cap Material	Color	Cap Liner	Autoclavable	Qty / Pack	Qty / Case
W239300	24-400	Solid Top	Phenolic	Black	14B Rubber	Yes	72	144
240218	24-400	Solid Top	Phenolic	Black	14B Rubber	Yes	—	500
240418	24-400	Solid Top	Phenolic	Black	PTFE / 14B Rubber	Yes	—	100
W240827	24-400	Solid Top	Phenolic	Black	PTFE / 14B Rubber	Yes	100	500
W242711	24-400	Solid Top	Phenolic	Black	PTFE / 14B Rubber	Yes	—	200
239257	24-400	Solid Top	Phenolic	Black	PE Cone	No	72	144
W240518	24-400	Open Top	Phenolic	Black	Linerless	Yes	—	200
W239301	28-400	Solid Top	Phenolic	Black	14B Rubber	Yes	72	144
240419	28-400	Solid Top	Phenolic	Black	PTFE / 14B Rubber	Yes	—	100
240119	28-400	Solid Top	Phenolic	Black	PE Cone	No	—	100
239259	28-400	Solid Top	Phenolic	Black	PE Cone	No	72	144
240319	28-400	Solid Top	Phenolic	Black	Metal Foil / Pulp	No	—	100
W239302	33-400	Solid Top	Phenolic	Black	14B Rubber	Yes	72	144
240421	33-400	Solid Top	Phenolic	Black	PTFE / 14B Rubber	Yes	—	100
240121	33-400	Solid Top	Phenolic	Black	PE Cone	No	—	100
239260	33-400	Solid Top	Phenolic	Black	PE Cone	No	72	144
240321	33-400	Solid Top	Phenolic	Black	Metal Foil / Pulp	No	—	100
240280	33-430	Solid Top	Phenolic	Black	14B Rubber	Yes	—	200
240480	33-430	Solid Top	Phenolic	Black	PTFE / 14B Rubber	Yes	—	100
240080	33-430	Solid Top	Phenolic	Black	LDPE	No	—	200
240680	33-430	Open Top	Phenolic	Black	Gray Chlorobutyl / 50 Septa	Yes	—	100
240683	33-430	Open Top	Phenolic	Black	Gray Chlorobutyl / 50 Septa	Yes	—	1000
W240540	33-430	Open Top	Phenolic	Black	Linerless	Yes	—	200
240223	38-400	Solid Top	Phenolic	Black	14B Rubber	Yes	—	200
W239303	38-400	Solid Top	Phenolic	Black	14B Rubber	Yes	—	72
240269	38-415	Solid Top	Phenolic	Black	14B Rubber	Yes	—	200
240281	38-430	Solid Top	Phenolic	Black	14B Rubber	Yes	—	200
240481	38-430	Solid Top	Phenolic	Black	PTFE / 14B Rubber	Yes	—	100
240181	38-430	Solid Top	Phenolic	Black	PE Cone	No	—	100
240381	38-430	Solid Top	Phenolic	Black	Metal Foil / Pulp	No	—	200
240081	38-430	Solid Top	Phenolic	Black	LDPE	No	—	200
W240382	38-439	Solid Top	Phenolic	Black	Metal Foil / Pulp	No	—	200
W239304	43-400	Solid Top	Phenolic	Black	14B Rubber	Yes	—	72
W239306	48-400	Solid Top	Phenolic	Black	14B Rubber	Yes	—	72
240228	51-400	Solid Top	Phenolic	Black	14B Rubber	Yes	—	100
W239308	58-400	Solid Top	Phenolic	Black	14B Rubber	Yes	—	72
240330	58-400	Solid Top	Phenolic	Black	Metal Foil / Pulp	No	—	200

Polypropylene Screw Caps

- Use these caps with WHEATON or other manufacturers' glass bottles or vials
- Polyvinyl liners can be used with mild acids, alkalis, solvents and alcohols
- Foamed polyethylene (PE) liner provides chemical resistance for acids, alkalis, solvents and alcohols
- PTFE faced foamed PE liner ideal for use with high purity chemicals, strong acids and solvents
- Open top caps provide access with a syringe
- Open top caps with pre-slit liner are ideal for use in automated liquid handling equipment



Cat. No.	Cap Size	Cap Style	Cap Material	Color	Cap Liner	Autoclavable	Qty / Pack	Qty / Case
239201	13-425	Solid Top	Polypropylene	White	Poly-Vinyl / Pulp	No	72	144
239401	13-425	Solid Top	Polypropylene	White	Poly-Vinyl / Pulp	No	—	15,000
239273	13-425	Solid Top	Polypropylene	White	Foamed PE	No	72	144
239225	13-425	Solid Top	Polypropylene	White	PTFE / Foamed PE	No	72	144
239425	13-425	Solid Top	Polypropylene	White	PTFE / Foamed PE	No	—	19,000
W240830	13-425	Solid Top	Polypropylene	White	Bonded PTFE / Silicone	Yes	—	250
W240831	13-425	Solid Top	Polypropylene	White	Bonded PTFE / Silicone	Yes	250	1000
W240840	13-425	Open Top	Polypropylene	White	Bonded PTFE / Silicone	Yes	—	250
W240841	13-425	Open Top	Polypropylene	White	Bonded PTFE / Silicone	Yes	250	1000
W242710	13-425	Open Top	Polypropylene	Black	Bonded PTFE / Silicone	Yes	—	250
W240848	13-425	Open Top	Polypropylene	Black	Pre-Slit Bonded PTFE / Silicone	Yes	—	250
W240849	13-425	Open Top	Polypropylene	Black	Pre-Slit Bonded PTFE / Silicone	Yes	250	1000
242210	15-415	Solid Top	Polypropylene	White	Foamed PE	No	—	200
239202	15-425	Solid Top	Polypropylene	White	Poly-Vinyl / Pulp	No	72	144
239274	15-425	Solid Top	Polypropylene	White	Foamed PE	No	72	144
239226	15-425	Solid Top	Polypropylene	White	PTFE / Foamed PE	No	72	144
W240832	15-425	Solid Top	Polypropylene	White	Bonded PTFE / Silicone	Yes	—	250
W240833	15-425	Solid Top	Polypropylene	White	Bonded PTFE / Silicone	Yes	250	1000
W240842	15-425	Open Top	Polypropylene	White	Bonded PTFE / Silicone	Yes	—	250
W240843	15-425	Open Top	Polypropylene	White	Bonded PTFE / Silicone	Yes	250	1000
W240850	15-425	Open Top	Polypropylene	Black	Pre-Slit Bonded PTFE / Silicone	Yes	—	250
W240851	15-425	Open Top	Polypropylene	Black	Pre-Slit Bonded PTFE / Silicone	Yes	250	1000
239203	18-400	Solid Top	Polypropylene	White	Poly-Vinyl / Pulp	No	72	144
239275	18-400	Solid Top	Polypropylene	White	Foamed PE	No	72	144
242212	18-400	Solid Top	Polypropylene	White	Foamed PE	No	—	200
239227	18-400	Solid Top	Polypropylene	White	PTFE / Foamed PE	No	72	144
242214	18-415	Solid Top	Polypropylene	White	Foamed PE	No	—	200
242216	20-400	Solid Top	Polypropylene	White	Foamed PE	No	—	200
239229	20-400	Solid Top	Polypropylene	White	PTFE / Foamed PE	No	72	144
242217	20-410	Solid Top	Polypropylene	White	Foamed PE	No	—	200
239207	22-400	Solid Top	Polypropylene	White	Poly-Vinyl / Pulp	No	72	144
242218	22-400	Solid Top	Polypropylene	White	Foamed PE	No	—	200
239231	22-400	Solid Top	Polypropylene	White	PTFE / Foamed PE	No	72	144
W240834	22-400	Solid Top	Polypropylene	White	Bonded PTFE / Silicone	Yes	—	100
W240835	22-400	Solid Top	Polypropylene	White	Bonded PTFE / Silicone	Yes	100	500
W240844	22-400	Open Top	Polypropylene	White	Bonded PTFE / Silicone	Yes	—	100
W240845	22-400	Open Top	Polypropylene	White	Bonded PTFE / Silicone	Yes	100	500
239209	24-400	Solid Top	Polypropylene	White	Poly-Vinyl / Pulp	No	72	144
239281	24-400	Solid Top	Polypropylene	White	Foamed PE	No	72	144
242220	24-400	Solid Top	Polypropylene	White	Foamed PE	No	—	200
240805	24-400	Solid Top	Polypropylene	White	Foil / Pulp	No	—	1000
239233	24-400	Solid Top	Polypropylene	White	PTFE / Foamed PE	No	72	144
239433	24-400	Solid Top	Polypropylene	White	PTFE / Foamed PE	No	—	5,500
W240836	24-400	Solid Top	Polypropylene	White	Bonded PTFE / Silicone	Yes	—	100
W240837	24-400	Solid Top	Polypropylene	White	Bonded PTFE / Silicone	Yes	100	500
W240846	24-400	Open Top	Polypropylene	White	Bonded PTFE / Silicone	Yes	—	100

Cat. No.	Cap Size	Cap Style	Cap Material	Color	Cap Liner	Autoclavable	Qty / Pack	Qty / Case
W240847	24-400	Open Top	Polypropylene	White	Bonded PTFE / Silicone	Yes	100	500
242222	24-410	Solid Top	Polypropylene	White	Foamed PE	No	—	200
239211	28-400	Solid Top	Polypropylene	White	Poly-Vinyl / Pulp	No	72	144
239283	28-400	Solid Top	Polypropylene	White	Foamed PE	No	72	144
242224	28-400	Solid Top	Polypropylene	White	Foamed PE	No	—	200
239235	28-400	Solid Top	Polypropylene	White	PTFE / Foamed PE	No	72	144
242225	28-410	Solid Top	Polypropylene	White	Foamed PE	No	—	200
239284	33-400	Solid Top	Polypropylene	White	Foamed PE	No	72	144
242226	33-400	Solid Top	Polypropylene	White	Foamed PE	No	—	200
239236	33-400	Solid Top	Polypropylene	White	PTFE / Foamed PE	No	72	144
242228	33-430	Solid Top	Polypropylene	White	Foamed PE	No	—	200
239213	38-400	Solid Top	Polypropylene	White	Poly-Vinyl / Pulp	No	—	72
239285	38-400	Solid Top	Polypropylene	White	Foamed PE	No	—	72
239237	38-400	Solid Top	Polypropylene	White	PTFE / Foamed PE	No	—	72
239214	43-400	Solid Top	Polypropylene	White	Poly-Vinyl / Pulp	No	—	72
239286	43-400	Solid Top	Polypropylene	White	Foamed PE	No	—	72
239238	43-400	Solid Top	Polypropylene	White	PTFE / Foamed PE	No	—	72
239287	45-400	Solid Top	Polypropylene	White	Foamed PE	No	—	72
239239	45-400	Solid Top	Polypropylene	White	PTFE / Foamed PE	No	—	72
239216	48-400	Solid Top	Polypropylene	White	Poly-Vinyl / Pulp	No	—	72
239288	48-400	Solid Top	Polypropylene	White	Foamed PE	No	—	72
239240	48-400	Solid Top	Polypropylene	White	PTFE / Foamed PE	No	—	72
239217	53-400	Solid Top	Polypropylene	White	Poly-Vinyl / Pulp	No	—	72
239289	53-400	Solid Top	Polypropylene	White	Foamed PE	No	—	72
239241	53-400	Solid Top	Polypropylene	White	PTFE / Foamed PE	No	—	72
239218	58-400	Solid Top	Polypropylene	White	Poly-Vinyl / Pulp	No	—	72
239290	58-400	Solid Top	Polypropylene	White	Foamed PE	No	—	72
239242	58-400	Solid Top	Polypropylene	White	PTFE / Foamed PE	No	—	72
239291	63-400	Solid Top	Polypropylene	White	Foamed PE	No	24	48
239243	63-400	Solid Top	Polypropylene	White	PTFE / Foamed PE	No	24	48
239443	63-400	Solid Top	Polypropylene	White	PTFE / Foamed PE	No	—	1,250
239220	70-400	Solid Top	Polypropylene	White	Poly-Vinyl / Pulp	No	24	48
239292	70-400	Solid Top	Polypropylene	White	Foamed PE	No	24	48
239244	70-400	Solid Top	Polypropylene	White	PTFE / Foamed PE	No	24	48
239222	89-400	Solid Top	Polypropylene	White	Poly-Vinyl / Pulp	No	24	48
239494	89-400	Solid Top	Polypropylene	White	Foamed PE	No	—	500
239246	89-400	Solid Top	Polypropylene	White	PTFE / Foamed PE	No	24	48
239446	89-400	Solid Top	Polypropylene	White	PTFE / Foamed PE	No	—	500

Microlink® Screw Caps

- Ideal for use with biological media, volatile solvents, corrosive chemicals and sensitive compounds
- Liner is ultrasonically welded to the cap to eliminate the possibility of glue contamination and bond failure common with autoclaving
- Available in convenient Lab Pack quantities as well as larger Case Packs
- Low-compression-set silicone ideal for the storage of samples for prolonged period of time over wide temperature ranges
- PTFE or polypropylene on the exposed face of the liner imparts an inert, chemical-resistant surface
- Open top caps provide access with a syringe
- Autoclavable



Cat. No.	Cap Size	Cap Style	Cap Material	Color	Cap Liner	Autoclavable	Qty / Case
240250-01	20-400	Solid Top	Polypropylene	White	PP / Silicone / PTFE	Yes	48
240250	20-400	Solid Top	Polypropylene	White	PP / Silicone / PTFE	Yes	600
240251-01	24-400	Solid Top	Polypropylene	White	PP / Silicone / PTFE	Yes	48
240240-01	28-400	Open Top	Polypropylene	White	PP / Silicone / PTFE	Yes	48
240241-01	33-400	Open Top	Polypropylene	White	PP / Silicone / PTFE	Yes	24
240241	33-400	Open Top	Polypropylene	White	PP / Silicone / PTFE	Yes	240
240106	33-430	Solid Top	Polypropylene	Black	PP / Silicone	Yes	50
240112	33-430	Open Top	Polypropylene	Black	PP / Silicone / PTFE	Yes	50
240235-01	38-430	Solid Top	Polypropylene	White	PP / Silicone / PP	Yes	24
240256-01	38-430	Solid Top	Polypropylene	White	PP / Silicone / PTFE	Yes	24
240114	38-430	Open Top	Polypropylene	Black	PP / Silicone / PTFE	Yes	50
240200	70-400	Solid Top	Polypropylene	White	PP / Silicone / PTFE	Yes	12

Septa for Open Top Caps, Autoclavable



Cat. No.	For Cap Size (mm)	Material	Qty / Case
Locking Flange Septa			
240563	33	Chlorobutyl / 50	100
Plain Septa			
W240580	8	Red PTFE Faced Silicone	100
W240581A	8	PTFE Faced Silicone	100
W240583A	13	PTFE Faced Silicone	100
W240593	13	PTFE Faced Butadiene	100
W240584A	15	PTFE Faced Silicone	100
W240594	15	PTFE Faced Natural Red Rubber	100
W240585	18	PTFE Faced Silicone	100
W240596	20	ETFE Faced Natural Red Rubber	100
W240586A	20	PTFE Faced Silicone	100
W240587	22	PTFE Faced Silicone	100
W240598A	24	PTFE Faced Semi-Translucent Silicone	100
W240588B	24	PTFE Faced White Silicone	100
W240599	24	PTFE / Silicone / PTFE	100
W240590	33	PTFE Faced Silicone	100
1052665	45	PTFE Faced Silicone for Celstir® Sidearm Cap	1

Liquid Scintillation Vial Screw Caps

- Screw caps for WHEATON liquid scintillation vials
- Use as replacement caps or for vials that are provided without caps
- Choose the right size screw cap for your vial
- Select cap and liner material for your application
- Not autoclavable



Cat. No.	Cap Size (mm)	Cap Material	Cap Liner Material	Qty / Case
241009	15-425	Urea	Metal Foil	1000
240804	22-400	Polypropylene	Metal Foil	1000
241017	22-400	Urea	Metal Foil	1000
240817	22-400	Urea	Polyethylene Disc	1000
240917	22-400	Urea	PE Cone	1000
241317	22-400	Polyethylene	Linerless	1000
240805	24-400	Polypropylene	Foil / Pulp	1000
241018	24-400	Urea	Metal Foil	1000
240818	24-400	Urea	Polyethylene Disc	1000

Polypropylene Screw Cap and Pour Ring

- Replacement caps for Lab 45™ media bottles
- 45mm screw thread
- Inner sealing ring
- Available with liner and center hole
- Autoclavable



Screw Cap, Polypropylene Pour Ring & Lyophilization Stopper

Cat. No.	Color	Description	Qty / Case
240726	White	Cap with Inner Sealing Ring	12
240726-03	Red	Cap with Inner Sealing Ring	12
240726-04	Blue	Cap with Inner Sealing Ring	12
240736	White	Cap without Inner Sealing Ring	12
240740	White	Cap with PTFE Faced Silicone Liner	12
240746	White	Cap with Center Hole	12
240756	—	Polypropylene Pour Ring	12



PBT Screw Cap



ETFE Pour Ring

Polybutylene Terephthalate Screw Cap

- With PTFE faced silicone liner
- 45mm screw thread
- Withstands temperatures up to 200°C
- Autoclavable

Cat. No.	Description	Cap Size	Qty / Case
240750	PBT Screw Cap	45mm	10
240760	ETFE Pour Ring	—	10

Glass Filled PP Screw Cap

- Open top polypropylene (PP) glass-filled cap
- Provides greater heat resistance than other PP caps
- PTFE / silicone septa bonded to cap
- Ideal for EPA samples



Cat. No.	Cap Size	Qty / Pack	Qty / Case
W224600	24-400	100	200

I-Loc™ Closure

- For use with Screw Neck Diagnostic Bottles
- Advantages of an aluminum seal with the convenience of a screw cap
- Polypropylene screw cap with gray bromobutyl / 50 stopper
- Autoclavable



Cat. No.	Cap Size	Color	Qty / Case
240676-01	20-400	Black	100
240676-02	20-400	White	100
240676-03	20-400	Red	100
240676-04	20-400	Blue	100
240676-05	20-400	Yellow	100



Polypropylene Screw Cap

- Unlined for use with WHEATON Glass Diagnostic Bottles
- Solid or open top screw caps
- Use with thin-flange lyophilization stoppers sold separately
- Five colors available
- Autoclavable

Cat. No.	Cap Size	Cap Style	Color	Qty / Case
240706-01	20-400	Solid Top	Black	300
240706-02	20-400	Solid Top	White	300
240706-04	20-400	Solid Top	Blue	300
240706-05	20-400	Solid Top	Yellow	300
240716-01	20-400	Open-Top	Black	300
240716-02	20-400	Open-Top	White	300
240716-03	20-400	Open-Top	Red	300
240716-04	20-400	Open-Top	Blue	300
240716-05	20-400	Open-Top	Yellow	300

Thin-Flange Lyophilization Stopper

224100-203	20mm	Thin-Flange	Gray	300
W224100-190	20mm	Snap-on Thin-Flange	Gray	1000

Polypropylene Screw Cap, Linerless

- Use these caps with WHEATON Leak Resistant Narrow Mouth Bottles
- Available in natural, white, red, blue and green



Cat. No.	Cap Size	Color	Autoclavable	Qty / Pack	Qty / Case
239501	13-425	Natural	Yes	12	72
239501-02	13-425	White	Yes	12	72
239501-03	13-425	Red	Yes	12	72
239501-06	13-425	Green	Yes	12	72

239506	20-410	Natural	Yes	12	72
239506-02	20-410	White	Yes	12	72
239506-03	20-410	Red	Yes	12	72
239506-04	20-410	Blue	Yes	12	72
239506-06	20-410	Green	Yes	12	72

239510	24-410	Natural	Yes	12	72
239510-02	24-410	White	Yes	12	72
239510-03	24-410	Red	Yes	12	72
239510-04	24-410	Blue	Yes	12	72
239510-06	24-410	Green	Yes	12	72

239512	28-410	Natural	Yes	12	48
239512-02	28-410	White	Yes	12	48
239512-04	28-410	Blue	Yes	12	48
239512-06	28-410	Green	Yes	12	48

239516	38-430	Natural	Yes	12	72
239516-02	38-430	White	Yes	12	72
239516-03	38-430	Red	Yes	12	72
239516-04	38-430	Blue	Yes	12	72

Snap Cap

- Use these caps with WHEATON Snap Cap sample bottles
- All sizes have tabs for easy removal
- Natural low density polyethylene



Cat. No.	Cap Size (mm)	Qty / Case
242612	22	200
242615	30	200
242616	34	200
242619	45	200





An Array of Tools for the Biological Sciences

Cell Culture

DWK Life Sciences has a long history of providing laboratory to production glassware and equipment. Quality is paramount in our manufacturing and performance is principal in the design. From sample preparation to storage and adherent cell culture to suspension culture, DWK Life Sciences understands the life sciences and their importance to all of us.

Highlights

- Industry standard tissue grinders and staining ware
- Roller culture equipment and Incubators designed to perform with production precision
- Spinner flasks and magnetic stirrers for multiple applications and scales
- Turn key bioreactor systems; autoclavable, customizable, suspension culture systems

Cell Culture

- > Bench-Top Systems.....57-58
- > CELLline™ Bioreactors..... 51
- > Culture Flasks64
- > Culture Tubes63
- > Erlenmeyer Shake Flasks52
- > Homogenizers.....55
- > Hybridization Bottles63
- > Incubators56
- > Magnetic Stirrers57
- > Roller Apparatus 53-55
- > Roller Bottles.....55
- > Spinner Flasks.....65
- > Staining Ware 59-60
- > Tissue Grinders61-63



CELLine™ Bioreactors

Our CELLine flasks are designed to enhance small scale bio-production for antibody and protein generation. Conventional *in vivo* or *in vitro* cell culture methods can be laborious, may have low cell density and require significant purification. CELLine flasks address these three areas of limitation observed in static tissue culture flasks.

How does the CELLine Flask Work?

Media Compartment – The media compartment allows for bulk storage of cell culture growth medium. This reduces the media refreshing requirement significantly as the media compartment is fifty times the size of the cell compartment.

Metabolite Regulating Upper Membrane – The upper dialysis membrane has a 10 kDa cut off limit. This regulates the flow of metabolites to and from the cell compartment and retains all proteins in the cell compartment.

Cell Compartment – The cell compartment provides the ideal area to inoculate and achieve high density cultures. The compartment concentrates cells, their products, and limits the requirement for any exogenous growth factors.

Gas Permeable Lower Membrane – With static cultures, gas transfer rates can be the limiting factor in high density cultures. The CELLine flask places the cells directly against the gas permeable membrane to achieve optimal levels of oxygen and carbon dioxide.

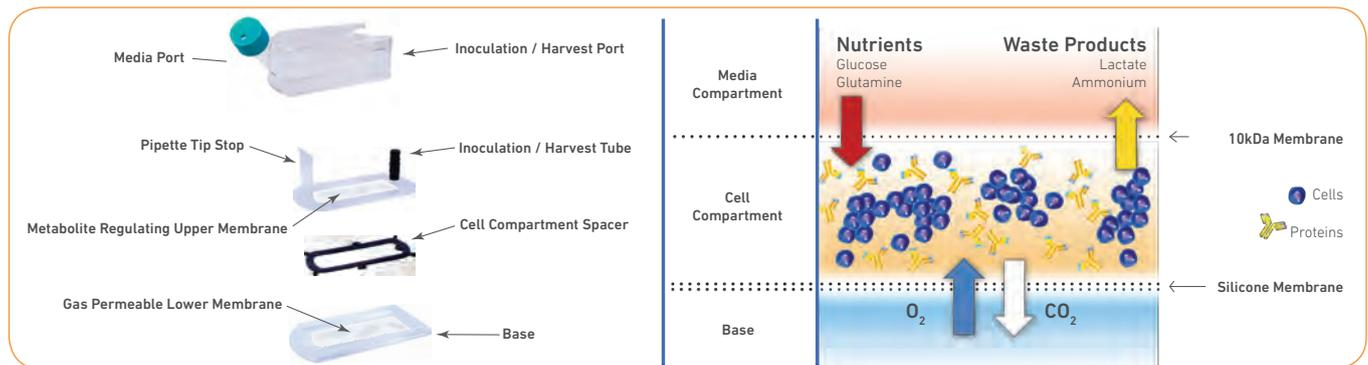

Note: Exploded view of device; unit is packaged fully assembled

Cat. No.	Flask Type	Culture Type	Media (mL) Compartment Size	Cell (mL) Compartment Size	Qty / Case
WCL1000-1	CELLine 1000	Suspension	1000	15	1
WCL1000-3	CELLine 1000	Suspension	1000	15	3
WCL1000AD-1	CELLine 1000-AD	Adherent	1000	15	1
WCL1000AD-3	CELLine 1000-AD	Adherent	1000	15	3
WCL0350-1	CELLine 350	Suspension	350	5	1
WCL0350-5	CELLine 350	Suspension	350	5	5

Benefits of CELLine Flask

- Disposable and ready-to-use
- High cell density and high product concentration
- Reduces operation time
- Decreases use of consumables
- Cost-efficient, space saving, and stackable
- No additional equipment required for operation



WHEATON Erlenmeyer Shake Flasks

WHEATON Erlenmeyer Flasks are manufactured with virgin, optically clear, non-leaching LEXAN resin that retains clarity after gamma irradiation. The flasks are certified pyrogen-, DNase- and RNase-free and are packaged particulate free and wrapped in an easy tear, sterile bag. WHEATON Flasks are ideal for all suspension cell cultures, including baculovirus, microbial and algae cultures, as well as media preparation, storage and all related applications. WHEATON Flasks fit all standard shaking incubator systems and can be placed on any platform. In addition, DWK Life Sciences offers Shaker Flask Clamps for use with our flasks.

Benefits of WHEATON Erlenmeyer Flasks:

- Ideal replacement for glass and other Erlenmeyer / Shaker Flasks
- Patented DuoCAP® allows sterile air exchange or a leak resistant seal
- Minimize oxidation or pH shifts
- Perform aerobic/anaerobic culture
- Available with septum cap for pathogen containment
- Re-autoclavable, reusable
- Individually packed in easy tear bags
- Sterile to SAL 10⁻⁶
- Available with a flat or baffled base
- Baffled base flasks are ideal when increased levels of oxygenation and mixing are required

	125mL	250mL	500mL	1L (1000mL)	2L (2000mL)	3L (3000mL)
Flat Base	WPFPC0125S	WPFPC0250S	WPFPC0500S	WPFPC1000S	WPFPC2000S	WPFPC3000S
Baffled Base	WPFBC0125S	WPFBC0250S	WPFBC0500S	WPFBC1000S	WPFBC2000S	WPFBC3000S
Closure Size	38-430	38-430	38-430	53B	53B	69B
Units/Pack	24	12	12	6	6	3

WHEATON Shaker Clamps

WHEATON Polypropylene Shaker Flasks Clamps are carefully engineered to provide both clipping elasticity and motion resistance in one product. WHEATON Shaker Clamps feature a non-scratch design and are offered in a standard blue color accompanied by stainless steel screws and washers. The Clamps fit all industry standard shaking incubators and are autoclavable for reuse.

Cat. No.	WPSFC2000	WPSFC1000	WPSFC0500	WPSFC0250	WPSFC0125
Size	2000mL	1000mL	500mL	250mL	125mL
Height (mm)	89.57	74.5	63.14	57.63	51.17
Diameter (mm)	169.1	143.9	111.6	90.4	74.72



WHEATON Standard Roller



Refer to page 146 for plug styles.

- Smooth ramping digitally controlled rotation accurate to 0.01 RPM
- Maintenance free precision brushless motor
- Bright LCD display for easy operation
- Multiple decking and capacity configurations available for process flexibility
- See page 55 for additional options

Specifications

Capacity: 5-88 Positions
 Bottle Speed (110mm Bottle, other speeds available): ... 0.25-8.1 RPM
 Bottle Diameter: 108-121mm
 Bottle Length: Up to 550mm
 Accuracy: 0.01 RPM
 Drive: Belt Driven
 Motor Type: Brushless DC
 Rotation Direction: Clockwise and Counter-Clockwise
 Options: Rotation Alarm and Battery Backup
 Remote Communication: Dry Contact Relay
 Humidity: 80% up to 31°C
 Operating Temperature: 10 to 40°C
 Electrical: 100-240 VAC, 50/60 Hz, 35W

WHEATON R2P™ 2.0 Roller Apparatus



NEW touch screen functionality



- Robust touch screen interface that is easy to view from a distance
- Readily recognized icons for intuitive navigation
- Digitally controlled maintenance free motor accurate to 0.01 RPM
- Capable of remote interface and monitoring through SCADA systems
- Multiple decking and capacity configurations available for process flexibility
- See page 55 for additional options



Main Screen



Bottle Speed



Factory Setup



Profile



Temperature Alarm

Specifications

Capacity: 5-88 Positions
 Bottle Speed (110mm Bottle, other speeds available): ... 0.25-8.1 RPM
 Accuracy: 0.01 RPM
 Drive: Belt Driven
 Motor Type: Brushless DC
 Rotation Direction: Clockwise, Counter-Clockwise and Rocking
 Rotation Alarm: Included
 Options: Temperature Monitoring and Battery Backup
 Remote Communication: Yes, Modbus® Protocol and WHEATON Protocol via Ethernet and RS422
 Humidity: 80% up to 31°C
 Operating Temperature: 10 to 40°C
 Electrical: 100-240 VAC, 50/60 Hz, 35W

Ordering Information

DWK Life Sciences specializes in standard and customized roller apparatus units. The part numbering system below allows for the configuration of a standard system. The main components that make up a unit include the control system, the size and type of roller bottle decks and system options. There is also a table below listing the most commonly used roller apparatus. If you have any questions about custom bottle sizes, rotation speeds or standard systems do not hesitate to contact your DWK Life Sciences representative.

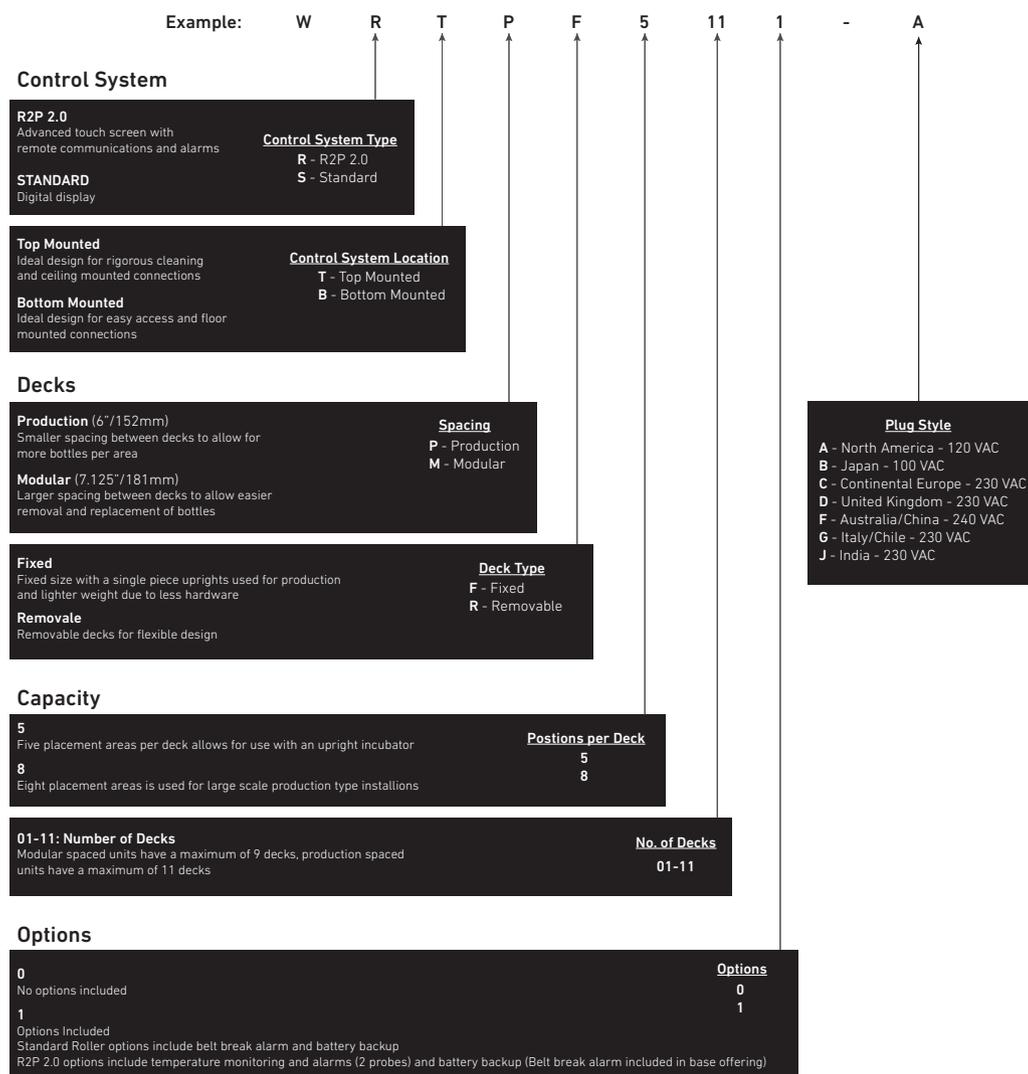

Refer to page 56 for Roll-In Incubators.

Part Numbers and Sizing Information for Most Common Systems

Part Number	# Positions	# Decks	Width (in / cm)	Depth (in / cm)	Height (in / cm)	Weight (lb / kg)	# of Bottle Positions	Control System
Bottom Drive Production Spacing								
WRBPR5010-A	5	1	31 / 79	25 / 63	14 / 35	52 / 24	5	R2P 2.0
WRBPR5030-A	5	3	31 / 79	25 / 63	26 / 65	85 / 39	15	R2P 2.0
WRBPF5110-A	5	11	31 / 79	25 / 63	74 / 187	217 / 99	55	R2P 2.0
WRBPF8110-A	8	11	47 / 120	25 / 63	74 / 187	360 / 167	88	R2P 2.0
Bottom Drive Modular Spacing								
WRBMR5010-A	5	1	30 / 76	25 / 63	14 / 34	70 / 32	5	R2P 2.0
WSBMR5010-A	5	1	30 / 76	25 / 63	14 / 34	70 / 32	5	Standard
WRBMR5030-A	5	3	30 / 76	25 / 63	29 / 74	112 / 51	15	R2P 2.0
WSBMR5030-A	5	3	30 / 76	25 / 63	29 / 74	112 / 51	15	Standard
WRBMR5070-A	5	7	30 / 76	25 / 63	57 / 145	196 / 89	35	R2P 2.0
WSBMR5070-A	5	7	30 / 76	25 / 63	57 / 145	196 / 89	35	Standard
WRBMR5090-A	5	9	30 / 76	25 / 63	71 / 179	238 / 108	45	R2P 2.0
WSBMR5090-A	5	9	30 / 76	25 / 63	71 / 179	238 / 108	45	Standard
Top Drive Production Spacing								
WRTPF5110-A	5	11	31 / 79	25 / 63	75 / 190	250 / 113	52	R2P 2.0
WSTPF5110-A	5	11	31 / 79	25 / 63	75 / 190	250 / 113	52	Standard
WRTPF8110-A	8	11	47 / 120	25 / 63	75 / 190	350 / 159	86	R2P 2.0
WSTPF8110-A	8	11	47 / 120	25 / 63	75 / 190	350 / 159	86	Standard

Roller Options Information

Rotation Alarm (Included with R2P 2.0) – The rotation alarm employs two magnetic sensors to ensure that all main pulleys are rotating on the unit. This is included on all R2P 2.0 Roller Apparatus.

Battery Backup – The battery backup protects cells during transport, processing and power outages. The unit automatically and seamlessly switches over to battery power to provide rotation for 12 – 24 hours. Bottom mounted control systems house larger, longer lasting batteries.

Temperature Monitoring / Alarm Option (R2P 2.0 Only) – This option includes two precision temperature probes for real time temperature monitoring and deviation alarms. The temperature is displayed on the touch screen, screen saver for quick confirmation of optimal operating conditions.

WHEATON Field Installation Options Packages

Cat. No.	System
W348890V2	Standard Roller Top Drive System Options with Rotation Alarm and Battery Backup
W348891V2	Standard Roller Bottom Drive System Options with Rotation Alarm and Battery Backup
W348892V2	R2P 2.0 Roller Top Drive System Options with Battery Backup and Temperature Sensors (Rotation Alarm is already included with unit)
W348893V2	R2P 2.0 Roller Bottom Drive System Options with Battery Backup and Temperature Sensors (Rotation Alarm is already included with unit)

Please contact your DWK Life Sciences representative for information regarding retrofits, modifications, custom systems and deck kits for existing systems.

Roller Bottles

- Specifically designed for adherent cell roller culture
- Withstands repeated wet or dry sterilization cycles
- Borosilicate glass conforms to USP Type I and ASTM E 438 Type I, Class A requirements
- Available with different cap configurations



Cat. No.	Dia x Flat Overall Length (mm)	Usable Surface Area (cm ²)	Surface (cm ²)	Approx Capacity (mL)	Qty / Case
Roller bottle with 38mm deep skirted, black phenolic screw cap with white styrene-butadiene rubber liner (GPI 38-415)					
348252	110 x 240	550	680	1380	4
348253	110 x 285	700	840	1760	4
348256	110 x 480	1320	1500	3450	4
348258	110 x 550	1555	1680	4230	4
Roller bottle with 45mm white polypropylene screw cap with inner sealing ring and polypropylene pour ring.					
348272	110 x 240	550	680	1380	4
348273	110 x 285	700	840	1760	4
Roller bottle with 51mm black phenolic screw cap with shallow skirt and white styrene-butadiene rubber liner (GPI 51-400)					
348522	110 x 270	700	840	1760	4
348524	110 x 355	940	1070	2500	4
348528	110 x 535	1555	1680	4230	4

Deck Kit



Deck Kit For Modular Spaced Systems – The deck kit is designed for modular systems with removable decks. These are kits designed for customer installation.

Deck Kit For Production Spaced Systems – The deck kit is designed for production systems with removable decks. These are kits designed for customer installation.

Cat. No.	Description	Qty / Case
W348887	5 position deck, 7 1/8" Deck Spacing	1
W348889	5 position deck, 6" Deck Spacing	1

Power Homogenizer and Overhead Stirrer

- Dual purpose unit for use with tissue grinders or impellers
- Adjustable speed ranging from 300 – 5000 RPM under load
- Adjustable connector accepts stainless steel shafts up to 0.3125" (7.9mm) in diameter
- Aluminum rod and clamp included for unit mounting
- Electrical Requirements: 120 VAC, 50/60 Hz, 50 watts
- Dimensions: 4.5" x 5" x 12" (11.5 x 13 x 30cm)
- Weight: 6lbs (2.7kg)



Cat. No.	Description	Qty/Case
903475	Complete Unit	1

Accessories

Cat. No.	Description	Qty/Case
905275	Swivel Blade Paddle, Stainless Steel	1
905462	Extension Rod, 0.25" x 6" (6.3 x 153mm), Stainless Steel	1
905465	Extension Rod, 0.25" x 12" (6.3 x 305mm), Stainless Steel	1
905475	Extension Sleeve for 0.25" (6.3mm), Stainless Steel	1

Standard Incubator



- Compatible with:
 - Production-spaced R2P 2.0 and Standard rollers with up to 11 decks
 - Modular-spaced R2P 2.0 and Standard rollers with up to 9 decks
- User configurable shelving system and roller apparatus guide tracks (shelving sold separately)
- USB port and analog 4-20mA jack included for data logging temperature levels
- Designed for temperature uniformity
- Dry contact alarm port available for communicating alarm activation instances
- Large viewing window with an option for dual windows

CO₂ Incubator



- Compatible with:
 - Production-spaced R2P 2.0 and Standard rollers with up to 11 decks
 - Modular-spaced R2P 2.0 and Standard rollers with up to 9 decks
- Infrared sensor technology to maintain 0 to 20% CO₂ concentration
- Stainless steel interior
- User configurable shelving system and roller apparatus guide tracks (shelving sold separately)
- USB port and analog 4-20mA jack included for data logging temperature and CO₂ levels
- Dry contact alarm port available for communicating alarm activation instances
- Designed for temperature uniformity
- Large viewing window with an option for dual windows

Specifications

Capacity: 39.7 Cubic ft
 Interior Dimensions (W×D×H): .34.7 x 26 x 75" (88.1 x 66.0 x 190.5 cm)
 Exterior Dimensions(W×D×H): 42 x 32.4 x 88" (106.7 x 82.3 x 223.5cm)
 Control:.....Microprocessor Controlled ±0.1°C
 Temperature Range:.....8°C Above Ambient to 70°C
 Temperature Uniformity:..... Forced Air Circulation ±0.8°C at 37°C
 Electrical:.....100-240 VAC, 50/60 Hz, 12A-8A
 Shelving:..... 20 Maximum
 Interior Electrical Outlet:..... 1 (Chamber Ceiling)
 Net Weight:.....497 lb (225 kg)
 Shipping Weight: 657 lb (298.1kg)

Cat. No.	Plug Style	Voltage	Qty
W753681	North America	120 VAC	1
W753681-B-E	Japan	100 VAC	1
W753685-C-E	Continental Europe	230 VAC	1
W753685-D-E	United Kingdom	230 VAC	1
W753685-F-E	Australia / China	230 VAC	1
W753685-G-E	Italy / Chile	230 VAC	1
W753685-J-E	India	230 VAC	1

Refer to page 146 for plug styles.

Incubator Shelves (Not Supplied with Incubators)

Cat. No.	Description	Qty
753685	Painted Shelf for Standard	1
WI056028	Stainless Steel Shelf for CO ₂	1

Specifications

Capacity:39.7 Cubic ft
 Interior Dimensions(W×D×H): 35 x 26 x 75.5" (88.9 x 66 x 191.7 cm)
 Exterior Dimensions(W×D×H): .42.5 x 34.5 x 89" (108 x 87.6 x 226 cm)
 Control:..... Microprocessor controlled ±0.1°C
 Temperature Range:..... 8°C above Ambient to 70°C
 Temperature Uniformity:.....Forced Air Circulation ±0.5°C at 37°C
 Electrical:.....100-240 VAC, 50/60 Hz, 15A-10A
 CO₂ Range:.....0-20%
 CO₂ Sensor:..... IR
 CO₂ Rate:.....<5min (Recovery)
 CO₂ Connection: ¼" (6.35mm) Hose Barb
 CO₂ Inlet pressure:..... 15-20 psi (0.1.03-1.378 bars)
 Jacket Type:.....Air
 Shelving:..... 30 Maximum
 Interior Electrical Outlet:.....1 (Chamber Ceiling)
 Net Weight:.....574lb (260.4kg)
 Shipping Weight:682lb (309.4kg)

Cat. No.	Plug Style	Voltage	Qty
WI057608	North America	120 VAC	1
WI057608-C-E	Continental Europe	230 VAC	1
WI057608-D-E	United Kingdom	230 VAC	1
WI057608-F-E	Australia / China	230 VAC	1
WI057608-J-E	India	230 VAC	1

Refer to page 146 for plug styles.

Micro-Stir® Magnetic Stirrer & BioStir® Magnetic Stirrers

Micro-Stir® Magnetic Stirrer

- Ideal for low speed shear sensitive mixing
- 5-200 RPM, single and four place units
- Programmable, remote control and alarm capable



Cat. No.	Description	Qty / Case
W900700- []	Single Place Micro-Stir®	1
W900701- []	Four Place Micro-Stir®	1

Refer to page 146 for plug styles when ordering.

BioStir® Magnetic Stirrer

- Ideal for general mixing and difficult to dissolve solutes
- 150-1200 RPM, single and four place units
- Programmable, remote control and alarm capable



Cat. No.	Description	Qty / Case
W900702- []	Single Place BioStir®	1
W900703- []	Four Place BioStir®	1

Refer to page 146 for plug styles when ordering.

Specifications

Electrical:

Operating Voltage:.....100-240 VAC, 50/60 Hz
 Power Consumption:..... 15 Watts
 Pollution Degree:..... Class 2

Environmental:

Operating Temperature:.....15° to 40°C
 Humidity:80% up to 31°C, 50% at 40°C
 Altitude Limit:..... 2000m

Operating Speed:

Micro-Stir®5-200 RPM
 BioStir® 150-1200 RPM
 Maximum Flask Size:..... 3L Flask

Dimensions: H x W x D

Single Place:..... 3.6 x 8 x 9.8" (9.2 x 20.3 x 24.9cm)
 Four Place:.....4 x 15.5 x 17.5" (10.2 x 39.4 x 44.5cm)

Weight:

Single Place:..... 4.5lb (1.9kg)
 Four Place:..... 10lb (4.5kg)

Remote Control Unit

- Ideal for sensitive procedures or difficult to reach areas
- Same interface layout as Micro-Stir® and BioStir® stirrers
- Slim communication cord; no power cord required



Cat. No.	Description	Qty / Case
W900704	Remote Control	1

Bench-Top Systems – Mini-Bottle

- Allows for serum and media bottles as well as culture tubes
- For cell cultivation or staining procedures
- Accommodates bottles 38 to 60mm in diameter and 240mm long
- Deck kits available to double or triple capacity



Shown with Additional Deck Kit



Specifications

Capacity:..... 4-12 Positions
 Bottle Speed:..... 2-45 RPM (dependent on bottle size)
 Bottle Diameter:..... 38-60mm
 Bottle Length:.....Up to 240mm
 Weight:18lb (8kg)
 Dimensions: W x D X H..... 12.25 x 12.75 x 7.125" (32 x 32.5 x 18cm)
 Humidity: 80% up to 31°C
 Operating Temperature:.....10 to 40°C
 Electrical:..... 100-240 VAC, 50/60 Hz, 14W

Cat. No.	Plug Style	Voltage	Qty / Case
W348923-A	North America	120 VAC	1
W348923-B	Japan	100 VAC	1
W348923-C	Continental Europe	230 VAC	1
W348923-D	United Kingdom	230 VAC	1
W348923-F	Australia / China	240 VAC	1
W348923-G	Italy / Chile	230 VAC	1
W348923-J	India	230 VAC	1

Refer to page 146 for plug styles when ordering.

Additional Deck Kit



Cat. No.	Description	Qty / Case
W348920-CH	Deck Kit for Mini Bottle Bench-Top Roller Rack	1

Bench-Top Systems – Small Bottle

- Allows for use with glass or plastic roller bottles
- For cell cultivation research and pilot applications
- Accommodates two bottles 75 to 121mm in diameter and 290 mm long
- Deck kits available to double or triple capacity



Specifications

Capacity: 2-6 Positions
 Bottle Speed: 0.1-3.8 RPM (110mm diameter bottle)
 Bottle Diameter: 75-121mm
 Bottle Length: Up to 290mm
 Weight: 18lb (8kg)
 Dimensions: W x D X H.....12.25 x 12.75 x 7.125" (32 x 32.5 x 18cm)
 Humidity: 80% up to 31°C
 Operating Temperature: 10 to 40°C
 Electrical: 100-240 VAC, 50/60 Hz, 14W

Cat. No.	Plug Style	Voltage	Qty / Case
W348924-A	North America	120 VAC	1
W348924-B	Japan	100 VAC	1
W348924-C	Continental Europe	230 VAC	1
W348924-D	United Kingdom	230 VAC	1
W348924-F	Australia / China	240 VAC	1
W348924-G	Italy / Chile	230 VAC	1
W348924-J	India	230 VAC	1

Refer to page 146 for plug styles when ordering.

Additional Deck Kit



Cat. No.	Description	Qty / Case
W348930-CH	Deck Kit for Small Bottle Bench-Top Roller Rack	1



Staining Dish, 10-20 Slide Unit

- This 20-slide unit is the standard for manual staining procedures
- The removable glass slide rack has an open bottom to facilitate rapid immersion and drainage, reducing carryover
- The rack holds 10 single slides, 19 slides arranged alternately straight across and diagonally, or 20 slides back-to-back of standard size:
3" x 1" (75 x 25mm), 3" x 1-1/2" (75 x 38mm) and 3" x 2" (75 x 51mm) sizes
- Manufactured from soda-lime glass
- Approximate inside bottom dimensions (mm): 91 L x 71 W x 60 D



Cat. No.	Description	Qty / Case
900200	Complete (Dish, Cover, Rack, Handle)	6
900201	Dish	3
900202	Cover	3
900203	Dish and Cover	3
900204	Glass Slide Rack	3
900205	Handle	6

Staining Dish, 10-20 Slide Unit

- Designed for staining 3" x 1" (75mm x 25mm) microscope slides
- Holds 10 single slides, or 19 slides arranged alternately straight across and diagonally, or 20 slides back-to-back
- Manufactured from soda-lime glass
- Approximate inside bottom dimensions (mm): 75 L x 55 W x 35 D



Cat. No.	Description	Qty / Case
900170	Staining Dish, with Cover	6

Staining Dish, 16-40 Slide Unit

- These mix-and-match components offer greater flexibility in meeting your requirements
- This staining dish accommodates 16, 20 and 30 slide racks
- It holds slides sizes 3" x 1" (75mm x 25mm), 3" x 1-1/2" (75mm x 38mm), and 3" x 2" (75mm x 51mm)
- Manufactured from soda-lime glass
- Approximate inside bottom dimensions (mm): 121 L x 90 W x 66 D



Cat. No.	Description	Qty / Case
900303	Dish and Cover	6
900301	Dish	3
900302	Cover	3
900234	30-Slide Rack Stainless Steel with Hinged Handle	3
900254	16-32 Slide Rack, Glass	3
900304	20-40 Slide Rack, Glass	3

Staining Dish, 50-Slide Unit



- This slotted rack holds 50 microscope slides, sizes 3" x 1" (75mm x 25mm), 3" x 1-1/2" (75mm x 38mm), and 3" x 2" (75mm x 51mm)
- The rack is made of non-tarnishable stainless steel that is resistant to staining solutions
- The handle is permanently attached, but hinged to permit closure of the dish and easy insertion and removal of the microscope slides
- Manufactured from soda-lime glass
- Approximate inside bottom dimensions (mm): 185 L x 88 W x 78 D

Cat. No.	Description	Qty / Case
900400	Complete (Dish, Cover, and Rack)	6
900401	Dish	3
900402	Cover	3
900403	Dish and Cover	3
900404	50-Slide Stainless Steel Rack, with Handle Attached	3

Staining Dish, 8-16 Slide Unit

- It holds 8 individual 3" x 1" (75mm x 25mm) slides or, if necessary, 16 slides back-to-back
- Includes glass lid
- This Hellendahl-type dish can be used for staining or as a TLC developing chamber
- Manufactured from soda-lime glass
- Approximate inside bottom dimensions (mm): 76 L x 25 W x 75 D



Cat. No.	Description	Qty / Case
900630	Staining Dish	6

Columbia Jar for Cover Slips

- These staining jars hold up to 4 cover slips 17-23mm wide, and up to 30mm long
- Longer cover slips can be accommodated if the cap is removed
- The jar includes a 43-400 white polypropylene screw cap with a PTFE coated polyethylene liner
- Manufactured from soda-lime glass
- In addition to staining applications, Columbia Jars can be used for cleaning cover slips, as well as coating them with materials such as poly-lysine or silane



Cat. No.	Description	Qty / Case
W900180	Columbia Jar & Cap	1
W900180-6	Columbia Jar & Cap	6

Coplin Staining Jar, 5-10 Slide Unit

- This unit holds ten 3" x 1" (75mm x 25mm) slides, back-to-back that extend above the opening so you can manipulate them without using forceps
- Polypropylene screw cap
- The screw cap is made of linerless white polypropylene to reduce solvent evaporation and spills during storage
- Cap is not intended for use with slides in jar
- The unit has a rectangular base and holds approximately 55mL
- Manufactured from soda-lime glass
- Approximate inside bottom dimensions (mm): 26 L x 26 W x 70 D



Cat. No.	Description	Qty / Case
900520	Coplin Jar with PP Screw Cap	6
900522	Replacement Cap, 58-400	6

Coplin Staining Jar, 5-10 Slide Unit, with Screw Cap

- It holds five single 3" x 1" (75mm x 25mm) slides vertically, or 10 slides back-to-back
- This unit is used for staining slides, or as a developing chamber for thin-layer chromatography
- The screw cap is made of linerless white polypropylene to reduce solvent evaporation
- The unit has a rectangular base and holds approximately 60mL
- Manufactured from soda-lime glass
- Approximate inside bottom dimensions (mm): 26 L x 26 W x 90 D



Cat. No.	Description	Qty / Case
900570	Complete	6
900522	Replacement Cap, 58-400	6

Coplin Staining Jar, 5-10 Slide Unit

- It holds five single 3" x 1" (75mm x 25mm) slides vertically, or 10 slides back to back, and holds approximately 65mL
- This popular staining jar has heavy glass walls and a broad base for increased stability
- Manufactured from soda-lime glass
- Approximate inside bottom dimensions (mm): 28 L x 26 W x 92 D



Cat. No.	Description	Qty / Case
900470	Coplin Jar with Glass Cover	6

Coplin Staining Jar, 5-10 Slide Unit

- The chamber is designed with an extra tall lid to accept 5 single 25mm x 75mm and 25mm x 100mm slides or 10 slides back-to-back
- Extra tall lid accommodates 100mm slides
- Manufactured from soda-lime glass
- Approximate inside bottom dimensions (mm): 28 L x 26 W x 92 D



Cat. No.	Description	Qty / Case
276840	Staining Jar with Lid	6

Staining Jar, 8-10 Slide Unit

- The jar holds 8 single 3" x 1" (75mm x 25mm) slides vertically or 16 slides back-to-back
- This jar's wide top is designed for convenience in transferring slides, making it especially suitable for staining slides that are inscribed on one end
- Manufactured from soda-lime glass
- Approximate inside bottom dimensions (mm): 47 L x 26 W x 85 D



Cat. No.	Description	Qty / Case
900620	Staining Jar with Cover	6

Slide Grip

- Polypropylene grip allows for easy and safe transfer of five slides to other containers for staining
- Fits into WHEATON Coplin staining jars (900570, 900470, 276840)



Cat. No.	Description	Qty / Case
900575	Slide Grip	2

Boerner Micro Test Slide

- Ideal for Boerner-Jones-Lukens microflocculation test
- This slide is used for procedures involving 0.01 to 0.15mL of fluid
- The slide has 10 cells in two rows of five each
- Each cell is 2.5mm deep and is designed to produce flattened drops of uniform depth
- Manufactured from soda-lime glass



Cat. No.	Description	Dimensions L x W (mm)	Qty / Case
798550	Boerner Micro Test Slide	109 x 58	12

Mounting Media / Balsam Bottle

- This bottle, manufactured from soda-lime glass, is ideal for applying mounting media
- It comes with a glass applicator rod and a glass cap, which is ground to the shoulder of the bottle to form a seal



Cat. No.	Size (mL)	Dia. x H (mm)	Qty / Case
208890	100	75 x 100	6

Alcohol Burner

- Glass cap is used to reduce evaporation of alcohol when not in use
- This burner, manufactured from soda-lime glass, is designed for use with isopropyl or denatured ethyl alcohol
- Its low-heat flame is well suited for microscopy purposes
- The unit is supplied with a ground glass cap
- The reservoir holds 100mL of alcohol



Cat. No.	Description	Dia. x H (mm)	Qty / Case
237070	Alcohol Burner	75 x 100	6

Replacement Parts

237071	Wick, 0.25" Dia x 6" L	—	25
237072	Cork Stopper Assembly	—	10

Dounce Tissue Grinder

- Retains high percentage of cell nuclei and mitochondria in soft tissues or from cell cultures
- Made from WHEATON 33 low extractable borosilicate glass
- Mortar has large reservoir and pouring lip making decanting easy
- Pestle ball encircled in liquid avoids heat build-up by reducing friction
- Contains both loose and tight pestles
- Loose pestle clearance range: 0.089-0.14mm
- Tight pestle clearance range: 0.025-0.076mm
- Unit can be autoclaved / sterilized to prevent cross contamination between samples



Cat. No.	Size (mL)	Mortar, OD x Length*	Overall Length*	Qty / Case
357538	1	11 x 48	125	2
357542	7	13 x 82	175	2
357544	15	22 x 94	210	2
357546	40	32 x 140	285	2

* measurement in mm

Tenbroeck Tissue Grinder

- Ideal for grinding liver, intestine and heart tissue
- Hollow pestle can be packed with ice and mortar contains expanded reservoir and pouring lip for easy decanting
- Made from WHEATON 33 low extractable borosilicate glass
- Components are interchangeably ground eliminating need to keep parts matched during cleaning
- Unit can be autoclaved / sterilized to prevent cross contamination between samples
- Pestle clearance range: 0.09 – 0.16mm



Cat. No.	Size (mL)	Mortar, OD x Length*	Overall Length*	Qty / Case
357421	1	11 x 48	140	2
357422	2	11 x 50	140	2
357424	7	16 x 82	190	2
357426	15	22 x 94	250	2
357428	40	32 x 140	320	2

* measurement in mm

Dounce Dura-Grind™ Tissue Grinder

- Precision machined from number 316 stainless steel provides a rugged alternative to glass Dounce tissue grinders
- Single pestle and mortar are supplied as a matched set to exacting tolerance of 0.013mm
- Smooth pestle action requires less effort than glass tissue grinders
- Mortar has a flat bottom allowing it to stand upright
- Unit cannot be autoclaved / sterilized



Cat. No.	Size (mL)	Mortar, OD x Length*	Overall Length*	Qty / Case
357572	7	35 x 114	171	1
357574	15	35 x 114	171	1
357576	40	44 x 114	171	1

* measurement in mm

Potter-Elvehjem Tissue Grinder

- PTFE pestle tip with 6.3mm diameter stainless steel rod can be used with power homogenization for soft tissue such as brain or liver
- Mortar made from WHEATON 33 low extractable borosilicate glass
- Components are interchangeable eliminating need to keep parts matched during cleaning
- Unit can be autoclaved / sterilized to prevent cross contamination between samples
- For added safety during power homogenization use safety coated tissue grinders
- Pestle clearance range: 0.1 – 0.15mm



Cat. No.	Size (mL)	Mortar, OD x Length*	Overall Length*	Qty / Case
358029	2	11 x 45	203	2
358034	5	13 x 66	219	2
358039	10	16 x 74	219	2
358044	15	19 x 84	219	2
358049	30	24 x 118	266	2
358054	55	30 x 130	266	2

Replacement Parts

358028	2mL Mortar	2
358033	5mL Mortar	2
358038	10mL Mortar	2
358043	15mL Mortar	2
358048	30mL Mortar	2
358053	55mL Mortar	2
358026	2mL Pestle	2
358031	5mL Pestle	2
358036	10mL Pestle	2
358041	15mL Pestle	2
358046	30mL Pestle	2
358051	55mL Pestle	2

* measurement in mm

Potter-Elvehjem Safe-Grind® Tissue Grinder

- Exterior plastic coated glass mortar provides greater safety during power homogenization
- PTFE pestle tip with 6.3mm diameter stainless steel rod can be used with power homogenization for soft tissue such as brain or liver
- Mortar made from WHEATON 33 low extractable borosilicate glass
- Components are interchangeable eliminating need to keep parts matched during cleaning
- Unit can be autoclaved / sterilized to prevent cross contamination between samples
- Pestle clearance range: 0.1 – 0.15mm



Cat. No.	Size (mL)	Mortar, OD x Length*	Overall Length*	Qty / Case
358003	2	11 x 45	203	2
358005	5	13 x 66	219	2
358007	10	16 x 74	219	2
358009	15	19 x 84	219	2
358011	30	24 x 118	266	2
358013	55	30 x 130	266	2

Replacement Parts

358004	2mL Mortar	2
358006	5mL Mortar	2
358008	10mL Mortar	2
358010	15mL Mortar	2
358012	30mL Mortar	2
358014	55mL Mortar	2

* measurement in mm

Potter-Elvehjem Tissue Grinder with Radial Serrations

- Serrated PTFE pestle tip design to disperse homogenate into the mortar cylinder more efficiently
- 6.3mm diameter stainless steel rod with PTFE pestle can be used with power homogenization for soft tissue such as brain or liver
- Mortar made from WHEATON 33 low extractable borosilicate glass
- Components are interchangeable eliminating need to keep parts matched during cleaning
- Unit can be autoclaved / sterilized to prevent cross contamination between samples
- Pestle clearance range: 0.1 – 0.15mm



Cat. No.	Size (mL)	Mortar, OD x Length*	Overall Length*	Qty / Case
357969	2	11 x 45	203	2
357974	5	13 x 66	219	2
357979	10	16 x 74	219	2
357984	15	19 x 84	219	2
357989	30	24 x 118	266	2
357994	55	30 x 130	266	2

Replacement Parts

358028	2mL Mortar	2
358033	5mL Mortar	2
358038	10mL Mortar	2
358043	15mL Mortar	2
358048	30mL Mortar	2
358053	55mL Mortar	2
357966	2mL Serrated Pestle	2
357971	5mL Serrated Pestle	2
357976	10mL Serrated Pestle	2
357981	15mL Serrated Pestle	2
357986	30mL Serrated Pestle	2
357991	55mL Serrated Pestle	2

* measurement in mm

Potter-Elvehjem Micro Tissue Grinder

- Micro size for extremely precise work when delicate hand operation is required
- Made from WHEATON 33 low extractable borosilicate glass
- Reservoir and pouring lip provide easy decanting of micro sample
- Unit can be autoclaved / sterilized to prevent cross contamination between samples
- Pestle clearance range: 0.1 – 0.15mm

Cat. No.	Size (mL)	Mortar, OD x Length*	Overall Length*	Qty / Case
357844	0.1	4 x 65	110	2

Replacement Parts

357841	0.1mL Pestle	2
357843	0.1mL Mortar	2

* measurement in mm

Tapered Tissue Grinder

- Tapered ground glass surface on mortar and pestle homogenizes connective tissue including heart, muscle, lung, skin and plant tissue
- Grinding efficiency is improved and less time is required as compared to the Tenbroeck and Potter-Elvehjem designs
- Made from WHEATON 33 low extractable borosilicate glass
- Components are interchangeably ground eliminating need to keep parts matched during cleaning
- Unit can be autoclaved / sterilized to prevent cross contamination between samples
- Pestle clearance range: 0.1 – 0.15mm



Cat. No.	Size (mL)	Mortar, OD x Length*	Overall Length*	Qty / Case
358103	1	11 x 49	130	1
358107	3	11 x 86	220	1
358111	5	13 x 93	220	1
358115	15	18 x 114	240	1

Replacement Parts

358102	1mL Mortar	2
358106	3mL Mortar	2
358110	5mL Mortar	2
358114	15mL Mortar	2
358101	1mL Pestle	2
358105	3mL Pestle	2
358109	5mL Pestle	2
358113	15mL Pestle	2

* measurement in mm

Tapered Tissue Grinder with Steel Rod

- Tapered PTFE pestle tip with 6.3mm diameter stainless steel rod can be used with power homogenization for soft tissue such as brain or liver
- Mortar made from WHEATON 33 low extractable borosilicate glass
- Components are interchangeable eliminating need to keep parts matched during cleaning
- Unit can be autoclaved / sterilized to prevent cross contamination between samples



Cat. No.	Size (mL)	Mortar, OD x Length*	Overall Length*	Qty / Case
358133	1	11 x 49	130	1
358137	3	11 x 86	220	1
358141	5	13 x 93	220	1
358145	15	18 x 114	240	1

Replacement Parts

358132	1mL Mortar	2
358136	3mL Mortar	2
358140	5mL Mortar	2
358144	15mL Mortar	2
358131	1mL Pestle	2
358135	3mL Pestle	2
358139	5mL Pestle	2
358143	15mL Pestle	2

* measurement in mm

Micro Tissue Grinder Kit

- Made from WHEATON 33 low extractable borosilicate glass
- Complete kit includes 7 micro tissue grinders
- Packaged in polyethylene case with foam inserts.
- Replacement parts available separately
- Autoclavable Tissue Grinders



Cat. No.	Description	Qty / Kit	Qty / Case
358204	Complete Kit	1	1
Replacement Parts			
357421	1mL Tenbroeck Tissue Grinder	1	2
357535	0.5mL Tissue Grinder, G.P.I. 13-425 cap	1	2
357538	1mL Dounce Tissue Grinder	1	2
357844	0.1mL Tissue Grinder	1	2
357848	0.2mL Tissue Grinder	1	2
358029	2mL Potter-Elvehjem Tissue Grinder	1	2
358133	1mL Tapered Tissue Grinder	1	1

Disposable Micro Tissue Grinder

- Disposable to eliminate cross contamination and useful for radioactive samples
- Small grinder area allows for high sample recovery
- Made from WHEATON 33 low extractable borosilicate glass



Cat. No.	Size (mL)	ID x Length*	Overall Length*	Qty / Case
357860	0.75	8 x 44	88	25

* measurement in mm

Micro Tissue Grinder with PTFE Spacer

- PTFE spacer aligns the pestle and reduces aerosoling of the product
- Includes a finely ground glass pestle and tube
- Made from WHEATON 33 low extractable borosilicate glass
- Autoclavable



Cat. No.	Size (mL)	Mortar, OD x Length*	Overall Length*	Qty / Case
357848	0.2	7 x 33	115	2

* measurement in mm

Micro Tissue Grinder with Cap

- With PTFE Pestle and Screw Cap
- 13-425 open top screw cap and PTFE faced silicone rubber liner
- Made from WHEATON 33 low extractable borosilicate glass
- Autoclavable
- Pestle clearance range: 0.002-0.006" (0.05-0.15mm)



Cat. No.	Size (mL)	Mortar, OD x Length*	Overall Length*	Qty / Case
357535	0.5	13 x 37	115	2

Replacement Parts

357537	Pestle			2
--------	--------	--	--	---

* measurement in mm

Culture Tube with Screw Cap

- Culture tube for use with slant, shake and drum roller cultures
- Autoclavable and reusable
- Round-bottom design with screw on cap
- Manufactured from borosilicate glass that conforms to USP Type I and ASTM E 438 Type I, Class B requirements



Cat. No.	Capacity (mL)	Dia. x H (mm)	Cap Size	Qty / Case
With White 14B Rubber Lined Cap				
358606	11	16 x 100	15-415	144
358607	14	16 x 125	15-415	144
358610	27	20 x 150	18-415	144
With PTFE Faced 14B Rubber Lined Caps				
358646	11	16 x 100	15-415	144
358647	14	16 x 125	15-415	144
358650	27	20 x 150	18-415	144

Hybridization Bottle

- Nucleic acid and protein blotting procedures
- Designed to fit most hybridization ovens and membranes
- Bottles, seals and caps resistant to hybridization reagents
- Heavy 3.2mm sidewall construction for added safety
- Borosilicate glass conforms to USP Type I requirements



Cat. No.	Size ID x L (mm)	Cap Size (mm)	Qty
805000	35 x 75	45	1
805001	35 x 100	45	1
805003	35 x 150	45	1
805007	35 x 300	45	1
805011	70 x 300	70-400	1

Safety Coated Hybridization Bottle

- Slip resistant plastisol coating reduces breakage hazards
- Nucleic acid and protein blotting procedures
- Designed to fit most hybridization ovens and membranes
- Bottles, seals and caps resistant to hybridization reagents
- Borosilicate glass conforms to USP Type I requirements



Cat. No.	Size ID x L (mm)	Cap Size (mm)	Qty
805020	35 x 75	45	1
805021	35 x 100	45	1
805023	35 x 150	45	1
805027	35 x 300	45	1
805031	70 x 300	70-400	1

Hybridization Bottle Storage Rack

- Works with 35mm ID hybridization bottles
- Ideal for transportation and storage
- Acrylic construction holds up to 6 bottles



Cat. No.	Description	Qty
805015	Acrylic Storage Rack	1

Erlenmeyer Flask

- Ideal for media storage, water storage or buffer preparation
- Autoclavable with screw cap
- Constructed of borosilicate glass that conforms to USP Type I and ASTM E 438 Type I, Class A requirements
- Cap supplied with silicone rubber liner



Cat. No.	Capacity (mL)	Cap Size	Qty
635165	1000	38-430	1
635134	25	20-400	1



Nephelo Culture Flask

- For use with turbidity meter or nephelometer
- Scratch and striation free side tube
- Available with or without cleanout port
- Autoclavable borosilicate glass that conforms to USP Type I and ASTM E 438 Type I, Class A requirements
- 38-430 top cap and 20-415 sidearm cap have white styrene butadiene rubber liner

Cat. No.	Capacity (mL)	Vol. (mL)	Sidearm Size (mm)	Cleanout Port	Qty
351454	300	200	14 x 140	Yes	1
351456	300	200	19 x 140	Yes	1
351054	500	350	14 x 130	No	1
351486	500	250	19 x 140	Yes	1
351514	1000	600	14 x 140	Yes	1

Trypsinizing Flask

- For forming cell suspensions through trypsin digestion of connective proteins
- Fluted design improves homogenization
- Autoclavable with screw cap
- Constructed of borosilicate glass that conforms to USP Type I and ASTM E 438 Type I, Class A requirements
- Caps have white styrene butadiene rubber liner



Cat. No.	Capacity (mL)	Cap Size (mm)	Flask Size	Graduated	Qty
355392	35	24-430	50	No	1
355442	35	24-430	50	Yes	1
355394	150	38-430	250	No	1
355444	150	38-430	250	Yes	1
355395	300	38-430	500	No	1
355445	300	38-430	500	Yes	1
355397	700	51-400	1000	No	1

Trypsinizing Flask with Pourout

- For forming cell suspensions through trypsin digestion of connective proteins
- Fluted design improves homogenization
- Autoclavable with screw cap and pourout for easy decanting
- Constructed of borosilicate glass that conforms to USP Type I and ASTM E 438 Type I, Class A requirements
- 20-415 sidearm cap and top cap have white styrene butadiene rubber liner



Cat. No.	Capacity (mL)	Cap Size(mm)	Flask Size	Graduated	Qty
355752	35	24-430	50	No	1
355753	75	33-430	125	No	1
355803	75	33-430	125	Yes	1
355754	150	38-430	250	No	1
355804	150	38-430	250	Yes	1
355755	300	38-430	500	No	1
355757	700	51-400	1000	No	1
355807	700	51-400	1000	Yes	1

Shake Flask



Three baffle flask



Four baffle flask

- For use with orbital or reciprocating shakers
- Baffles improve aeration and mixing for microbial and bacterial cultures
- Break resistant lip for use with stopper, cotton plug or film cover
- Pinched neck design to reduce splashing on flasks with 4 baffles
- Autoclavable borosilicate glass that conforms to USP Type I and ASTM E 438 Type I, Class A requirements

Cat. No.	Capacity (mL)	Qty
With Three Baffles		
353255	50	1
353257	125	1
353259	250	1
353262	500	1
353264	1000	1
353266	2000	1
With Four Baffles		
354235	50	1
354237	125	1
354239	250	1
354242	500	1
354244	1000	1

Double Sidearm Celstir® Spinner Flask

- For suspension cell culture with a magnetic stirrer
- Adjustable paddle impeller and sterile design as stirrer shaft does not protrude through cap
- 1:1 headspace ratio for ideal gas exchange
- Bottom dimple to reduce cell aggregation (dimple on 125mL and larger flasks)
- Autoclavable borosilicate glass that conforms to USP Type I and ASTM E 438 Type I, Class A requirements



Cat. No.	Volume (mL)	Dia. x H (mm)	Cap Size, Top	Sidearm Size	Qty
356873	25	38 x 122	38-430	15-415	1
356875	50	38 x 141	38-430	15-415	1
356876	125	65 x 155	51-400	33-430	1
356879	250	85 x 175	51-400	33-430	1
356882	500	110 x 190	100-400	45mm	1
356884	1000	130 x 250	100-400	45mm	1
356887	3000	178 x 341	100-400	45mm	1
356889	6000	258 x 404	100-400	45mm	1
356890	8000	293 x 445	100-400	45mm	1

Jacketed Double Sidearm Celstir® Spinner Flask

- For suspension cell culture with a magnetic stirrer
- 360° water jacket for precise temperature control
- Inlet and outlet hose barb connections for 0.25" (6.35mm) ID tubing
- Autoclavable borosilicate glass that conforms to USP Type I and ASTM E 438 Type I, Class A requirements



Cat. No.	Volume (mL)	Dia. x H (mm)	Cap Size, Top	Sidearm Size	Qty
356943	25	54 x 134	38-430	15-415	1
356945	50	54 x 147	38-430	15-415	1
356946	125	80 x 162	51-400	33-430	1
356949	250	100 x 182	51-400	33-430	1
356952	500	130 x 195	100-400	45mm	1
356954	1000	150 x 260	100-400	45mm	1

Magna Flex™ Microcarrier Spinner Flask

- Designed for microcarrier cultures with a magnetic stirrer
- Gentle stirring action provided by a bulb-shaped glass impeller
- 1:1 headspace ratio for ideal gas exchange
- Autoclavable borosilicate glass that conforms to USP Type I and ASTM E 438 Type I, Class A requirements



Cat. No.	Volume (mL)	Dia. x H (mm)	Cap Size, Top	Sidearm Size	Qty
356830	125	65 x 155	51-400	33-430	1
356831	250	85 x 175	51-400	33-430	1
356832	500	110 x 190	100-400	45mm	1
356834	1000	130 x 250	100-400	45mm	1
356837	3000	178 x 341	100-400	45mm	1
356839	6000	258 x 404	100-400	45mm	1

Replacement Parts

Stainless Steel Shaft Assembly Kit

Cat. No.	For Flask Size (mL)	Qty
356874	25	1
356877	50	1
356878	125	1
356880	250	1
356883	500	1
356885	1000	1
356886	3000	1
356888	6000	1
356891	8000	1

Replacement Impellers

Cat. No.	For Flask Size (mL)	Qty
Celstir®		
356893	25	1
356895	50	1
356896	125	1
356899	250	1
356902	500	1
356904	1000	1
356907	3000	1
356909	6000	1
356910	8000	1

Magna-Flex™

356841	125	1
356842	250	1
356843	500	1
356844	1000	1
356847	3000	1
356848	6000	1
356849	8000	1

Replacement Flasks

Cat. No.	For Flask Size (mL)	Qty
Celstir® Only		
356913	25 – Celstir® Flask Only	1
356915	50 – Celstir® Flask Only	1
356930	8000 – Celstir® Flask Only	1
Celstir® & Magna-Flex™		
356916	125 – Celstir® / Magna Flex™ Flask Only	1
356919	250 – Celstir® / Magna Flex™ Flask Only	1
356922	500 – Celstir® / Magna Flex™ Flask Only	1
356924	1000 – Celstir® / Magna Flex™ Flask Only	1
356927	3000 – Celstir® / Magna Flex™ Flask Only	1
356929	6000 – Celstir® / Magna Flex™ Flask Only	1

Jacketed Celstir® Flask

356963	25 – Jacketed Celstir® Flask Only	1
356965	50 – Jacketed Celstir® Flask Only	1
356966	125 – Jacketed Celstir® Flask Only	1
356969	250 – Jacketed Celstir® Flask Only	1
356972	500 – Jacketed Celstir® Flask Only	1
356974	1000 – Jacketed Celstir® Flask Only	1

Replacement Sidearm Caps

Cat. No.	Cap Size	Cap Material	Liner	Qty / Case
W356870	15-415	Black Phenolic	PTFE / 14B Rubber	2
W356871	33-430	Black Phenolic	PTFE / 14B Rubber	2
W356872*	45mm	White PBT	PTFE / Silicone	2

*Autoclavable





Proven Products for Organic Chemistry & Environmental Analysis

Chemistry Glassware

This section consists of analytical apparatus that are commonly used in organic chemistry and the examination of environmental samples. The majority of the glassware in this section is fabricated with either our exclusive Clear-Seal™ joints or the WHEATON Connection® screw thread finish ends.

The smooth, unground Clear-Seal™ joints seal without grease, reducing the possibility of seizing. Clear-Seal™ joints are manufactured to American Standard Taper dimensions and can be used interchangeably with ground joints. However, when Clear-Seal™ joints are used exclusively, there is little chance of freezing and no chance of contamination or mess associated with other sealing methods.

The WHEATON Connection® basic design links two exterior-threaded glass components. The connection eliminates grease and the contamination that is commonly associated with ground joints. Also eliminated are clamps, hooks and springs. Durable polypropylene caps, high temperature phenolic caps, and PTFE faced silicone rings ensure a tight, inert seal. Lab safety is increased by completely preventing frozen joints.

Chemistry Glassware

- > Adapters & Connectors69
- > Arsine Generator.....70
- > Chemistry Kit.....73
- > Cyanide Distillation.....70
- > Diazomethane Generator.....71
- > Evaporative Concentrator.....71
- > Filtration Apparatus.....75-78
- > Soxhlet Extraction Apparatus.....71



Clamps, Standard Taper

- Color-coded clamps hold standard taper joints securely under moderate pressure
- Molded from polyoxymethylene (POM), an acetal resin
- Will not scratch glass and can withstand temperatures up to 150°C
- Resistant to bases and weak acids
- Not resistant to halogen gases and concentrated acids



Cat. No.	Standard Taper Joint Size	Color	Qty / Case
297746	14	Yellow	12
297749	19	Blue	12
297752	24	Green	12
297755	29	Red	12
297757	Assorted	Assorted	24

The WHEATON Connection® Screw Thread Connector

- Safely joins two exterior threaded glass components without hooks, springs or clamps
- Screw cap configuration creates a grease-free, vacuum-tight seal
- Inert contact surface
- Easy to assemble
- Connection can be used under moderate pressure to generate a gas or deliver a reagent under an inert atmosphere
- Available with white polypropylene or black phenolic caps
- Phenolic connectors have a working temperature of up to 180°C
- Autoclavable



Cat. No.	Screw Thread Size	Qty / Case
With White Polypropylene Cap		
125478	13-425 and 13-425	6
125480	13-425 and 20-400	6
125482	13-425 and 24-400	6
125486	20-400 and 20-400	6
125488	20-400 and 24-400	6
125504	24-400 and 24-400	6
With Black Phenolic Cap		
125492	13-425 and 13-425	6
125494	13-425 and 20-400	6
W125495	13-425 and 22-400	6
125496	13-425 and 24-400	6
125497	20-400 and 20-400	6
125499	20-400 and 24-400	6
125500	24-400 and 24-400	6

Clear-Seal™ Connecting Adapter

- Enable interfacing between standard semi-micro glassware and micro systems
- Feature a Clear-Seal™ inner joint on one end and a screw thread for the WHEATON Connection® on the other end
- 13-425 thread size comes with a screw cap and an "O" ring to seal thermometers, gas inlet tubes, etc
- Manufactured from WHEATON 33 low extractable borosilicate glass that conforms to ASTM E 438 Type I, Class A requirements



Cat. No.	Screw Thread Size	Standard Taper Joint	Qty / Case
139479	13-425	19/22	1

Clear-Seal™ Grease-Free Inner Joints

- Joints are formed from a unique wall tubing that is heavier than standard wall tubing for extra strength
- Manufactured from WHEATON 33 low extractable borosilicate glass that conforms to ASTM E 438 Type I, Class A requirements



Cat. No.	Standard Taper Joint	OD (mm)	Qty / Case
757769	19/22	17	6
757773	24/40	21	6

Clear-Seal™ Grease-Free Outer Joints

- Joints are formed from a unique wall tubing that is heavier than standard wall tubing for extra strength
- Manufactured from WHEATON 33 low extractable borosilicate glass that conforms to ASTM E 438 Type I, Class A requirements



Cat. No.	Standard Taper Joint	OD (mm)	Qty / Case
758966	14/20	18	6
758969	19/22	22	6
758973	24/40	28	6

Thermometer Adapter

- Adapter has an "O" ring that holds a thermometer or gas inlet tube securely
- A grease-free WHEATON Connection® on one end provides an inert connection with external-threaded glass components
- Adapter can also be used with gas inlet tubing and will accommodate any tube with an OD of 5 to 7mm



Cat. No.	Screw Thread Size	Qty
165996	20-400	1

Arsine Generator

- Used for arsenic analysis using silver diethyldithiocarbamate (SDDC) colorimetric method described in the 21st Edition (2005) of Standard Methods for the Examination of Water and Wastewater, Method 3500-As B
- Design eliminates the ball and socket joint connecting the scrubber and absorber components
- Assembled apparatus is freestanding and easy to use
- Manufactured from WHEATON 33 low extractable borosilicate glass that conforms to ASTM E 438 Type I, Class A requirements

Cat. No.	Description	Qty / Case
180030	Arsine Generator, Complete	1

Component Parts

180034	Scrubber Absorber Tube	1
635965	Reaction Flask, 200mL, 24/40 Joint	1
W357331	Short Disposable Pasteur Pipettes (150mm long)	1000
297746	Clamp, Acetal Resin, Size 14, Yellow	12
297752	Clamp, Acetal Resin, Size 24, Green	12
970440	Drying Tube, 14/20 Joint	1

Arsine Generator, Clear-Seal™ Joint

With Standard Taper 24/40 Clear-Seal™ Joint

- Engineered for arsenic analysis using the silver diethyldithiocarbamate (SDDC) colorimetric method
- Meets ASTM / USP and EPA specifications
- Arsine absorber (Cat. No. 180021) has a socket joint
- Scrubber tube (Cat. No. 180022) has a standard taper 24/40 Clear-Seal™ joint and a spherical 12/2 ball joint held together by a size 12 stainless steel ball joint clamp
- Manufactured from WHEATON 33 low extractable borosilicate glass that conforms to ASTM E 438 Type I, Class A requirements
- Reference: "Standard Test Method for Arsenic in Water," ASTM D2972

Cat. No.	Description	Qty / Case
180020	Arsine Generator, Complete	1

Component Parts

180021	Arsine Absorber Joint	1
180022	Arsine Scrubber Tube 24/40, 12/2 Joint	1
635926	Erlenmeyer Flask, 125mL, 24/40	1
297784-12	Clamp, Size 12/2, Stainless Steel	1

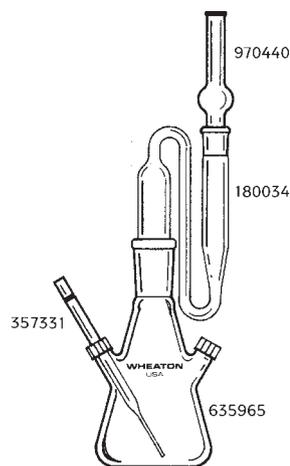

Arsine Generator

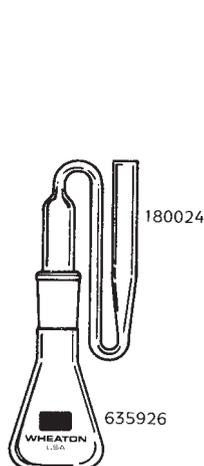

Arsine Generator, Modified

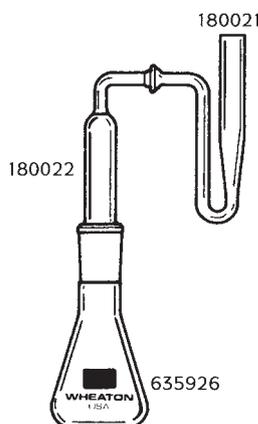

Arsine Generator, Clear Seal™ Joint

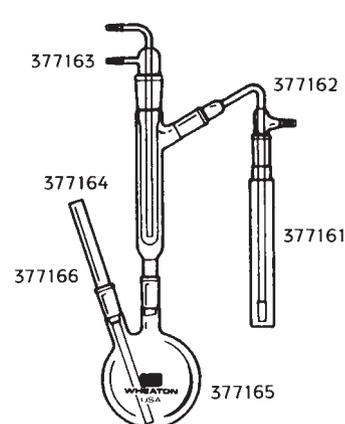

Cyanide Distillation Kit

Arsine Generator, Modified

With One-Piece Scrubber / Absorber Unit

- Modified version of catalog number 180020 for arsenic analysis
- Eliminates the cumbersome ball and socket joint connecting the scrubber and absorber tubes which conforms to ASTM / USP and EPA specifications
- The freestanding system has a standard taper 24/40 Clear-Seal™ joint
- Manufactured from WHEATON 33 low extractable borosilicate glass that conforms to ASTM E 438 Type I, Class A requirements
- Reference: "Standard Test Method for Arsenic in Water," ASTM D2972

Cat. No.	Description	Qty / Case
180023	Arsine Generator, Modified, Complete	1

Component Parts

180024	Scrubber Absorber Tube	1
635926	Erlenmeyer Flask, 125mL, 24/40	1

Cyanide Distillation Kit

With Clear-Seal™ Joints

- Ideal for removing interfering substances in quantitative analysis for cyanide
- The sample is reacted with H_2SO_4 and $MgCl_2$, which converts any cyanide to HCN
- HCN distills over and is absorbed in a NaOH solution, which is then analyzed for CN
- Manufactured from WHEATON 33 low extractable borosilicate glass that conforms to ASTM E 438 Type I, Class A requirements
- Utilizes standard taper Clear-Seal™ joints
- Reference: "Standard Test Method for Cyanides in Water," ASTM D2036

Cat. No.	Description	Qty / Case
377160	Cyanide Distillation Kit, Complete	1

Component Parts

377161	Absorber Tube, 19/38	1
377162	Absorber Top, 19/38	1
377163	Cold Finger, 29/42	1
377164	Cold Finger Jacket, 29/42	1
377165	Flask, 1000mL, 19/38	1
377166	Inlet Tube, 19/38	1

Diazomethane Generator

With Standard Taper Clear-Seal™ Grease-Free Joints

- Used to generate diazomethane and other gases for gas chromatography, mass spectroscopy and NMR studies using one millimole of Methylnitronitrosoguanidine (MNNG)
- Features Clear-Seal™ grease-free joints that have never been ground and does not require an "O" ring
- Includes a plastic standard taper joint clamp, a 13-425 screw cap with cut-out top and a PTFE faced rubber liner
- Manufactured from WHEATON 33 low extractable borosilicate glass that conforms to ASTM E 438 Type I, Class A requirements
- Note: Please use a safety shield and efficient fume hood when generating diazomethane or similar gases



Cat. No.	Description	Approx Height (mm)	Qty / Case
281135	Diazomethane Generator, Complete	190	1
W240593	13mm PTFE Faced Butadiene Septa	—	100

Diazomethane Generator

- Used to generate diazomethane and other gases for gas chromatography, mass spectroscopy and NMR studies using one millimole of Methylnitronitrosoguanidine (MNNG)
- Includes an "O" ring clamp, a 13-425 screw cap with a cut-out top and a PTFE faced rubber liner
- Manufactured from WHEATON 33 low extractable borosilicate glass that conforms to ASTM E 438 Type I, Class A requirements
- Note: Please use a safety shield and efficient fume hood when generating diazomethane or similar gases



Cat. No.	Description	Approx Height (mm)	Qty / Case
281155	Diazomethane Generator, Complete	200	1
281158	"O" ring for Cat. No. 281155		12
W240593	13mm PTFE Faced Butadiene Septa		100

Evaporative Concentrator, Kuderna-Danish

With Clear-Seal™ Joints

- Designed for the concentration of trace amounts of analyte in an organic solvent prior to analysis
- Smooth Clear-Seal™ joints eliminate the need for grease, reducing the possibility of contaminating the sample
- Complete unit consists of 270mm three-ball Snyder column, 500mL flask and 10mL receiving vessel
- Manufactured from WHEATON 33 low extractable borosilicate glass that conforms to ASTM E 438 Type I, Class A requirements

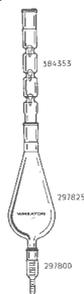

Cat. No.	Description	Qty / Case
297883	Kuderna-Danish Concentrator, Complete	1

Component Parts

384353	Snyder Column, 270mm, Three-Ball, with 24/40 Clear-Seal™ Joints	1
297825	500mL Flask, with 24/40 Top and 19/22 Bottom Clear-Seal™ Joints	1
297800	10mL Receiving Vessel, with 19/22 Clear-Seal Joint (Graduated 0-1 x 0.1mL; 2-10 x 0.5mL)	1

Micro Soxhlet Extraction Apparatus

With the WHEATON Connection®

- Used for continuous extraction of analytes from a solid into an organic solvent
- WHEATON Connection® eliminates the need for hooks, springs and clamps common to standard ground joint designs
- As the flask containing the solvent is heated, vapors rise in the larger outside tube, enter the water-cooled condenser, and liquefy
- When the liquid level in the extractor reaches the top of the bent tube, siphoning action returns the extract-enriched solvent to the flask
- Wetted parts are manufactured from either WHEATON 33 low extractable borosilicate glass that conforms to ASTM E 438 Type I, Class A requirements or PTFE



Cat. No.	Description	Qty / Case
415500	Micro Soxhlet Extractor, Complete	1

Component Parts

415501	85mm Condenser, 24-400 Screw Thread on Bottom and 13-425 Screw Thread on Side	1
415502	Extractor, 24-400 Screw Thread on Top and 20-400 Screw Thread on Bottom	1
125486	WHEATON Connection® 20-400 to 20-400	6
125504	WHEATON Connection® 24-400 to 24-400	6
635134	25mL Erlenmeyer Flask, 20-400 Screw Thread	1
962515	Hose Connector, 13-425	6
W416788	Extraction Thimble, Glass 15 x 60mm, 170-220µm Porosity	1

Soxhlet Extraction Apparatus

With Standard Taper Ground Joints

- Used for continuous extraction of analytes from a solid into an organic solvent
- As the flask containing the solvent is heated, vapors rise in the larger outside tube, enter the water-cooled condenser and liquefy
- When the liquid level in the extractor reaches the top of the bent tube, siphoning action returns the extract-enriched solvent to the flask
- Wetted parts are manufactured from WHEATON 33 low extractable borosilicate glass that conforms to ASTM E 438 Type I, Class A requirements

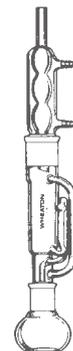

Cat. No.	Description	Qty / Case
416000	125mL Soxhlet Extractor, Complete	1
416005	250mL Soxhlet Extractor, Complete	1
416010	500mL Soxhlet Extractor, Complete	1

Component Parts

415000	190mm Extractor with 24/40 bottom inner joint and 34/45 top outer joint	1
415005	205mm Extractor with 24/40 bottom inner joint and 45/50 top outer joint	1
415010	250mm Extractor with 24/40 bottom inner joint and 55/50 top outer joint	1
334003	Allihn Reflux Condenser, 34/45	1
334014	Allihn Reflux Condenser, 45/50	1
334025	Allihn Reflux Condenser, 55/50	1
428126	Flat-Bottom Flask, 125mL, 24/40	1
428146	Flat-Bottom Flask, 250mL, 24/40	1
428164	Flat-Bottom Flask, 500mL, 24/40	1



WHEATON Micro Kit® for Organic and Environmental Chemistry

With Standard Taper 19/22 Clear-Seal™ Joints

- Apparatus for a wide range of organic chemistry experiments at a lower price than purchasing the components separately
- WHEATON standard taper Clear-Seal™ grease-free joints provide smooth, unground surfaces, which seal without grease and reduce seizing and contamination from grease
- Clear-Seal™ joints can replace ground units in any application and provide other important advantages over ground joints:
 - Superior in vacuum and radioactive applications
 - Smooth surfaces resist contamination
 - Cleaning is simple and thorough
 - Interchangeable with ground joints
 - All chemical changes and thermometer scales remain visible through the joints
 - Clear-Seal™ joints have never been weakened by grinding and are formed from special wall tubing that is heavier than standard wall for extra strength
 - Manufactured from WHEATON 33 low extractable borosilicate glass that conforms to ASTM E 438 Type I, Class A requirements
 - Clear-Seal™ joints are produced to American Standard Taper dimensions and can be used interchangeably with any standard taper ground joints
- Enjoy Clear-Seal™ joints exclusively or couple them with ground joints and get maximum results
- WHEATON Micro Kit® catalog number 773900 is packed in a high-density polyethylene case with a foam insert to protect components against breakage

Cat. No.	Description	Qty / Case
773900	Complete Kit	—
Component and Replacement Parts		
109933	Claisen Adapter	1
123753	Connecting Adapter	1
139479	Thermometer Adapter with "O" ring, 13-425 Cap	1
168353	Vacuum Distilling Adapter	1
327342	West Condenser, 200mm	1
385772	Distilling Column, 200mm	1
W438174	Round-Bottom Flask, 100mL	1
438764	Round-Bottom Flask, 250mL	1
438782	Round-Bottom Flask, 500mL	1
690170	Separatory Funnel with PTFE Stopcock, 125mL	1
923769	PTFE Stopper	1
964453	Bleed Tube	12

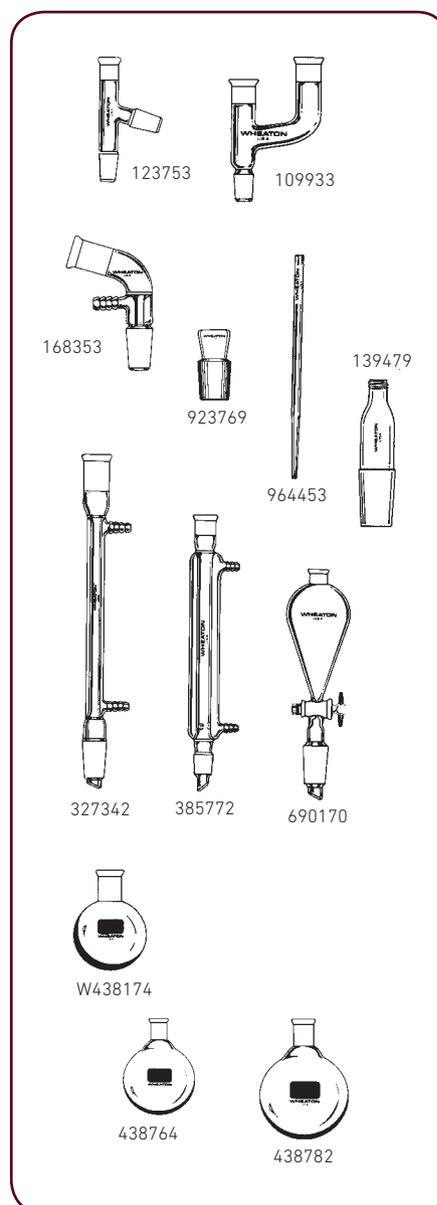



WHEATON
USA

§ 40/35

1000 ml

[Small white label]

58 Ce Cerium 140.12	59 Pr Praseodymium 140.9	90 Th Thorium 232	91 Pa Protactinium 231	92 U Uranium 238	93 Np Neptunium (237)	94 Pu Plutonium (244)
------------------------------	-----------------------------------	----------------------------	---------------------------------	---------------------------	--------------------------------	--------------------------------

25mm Filtration Assemblies with No. 5 Stopper Connections

- Designed to handle small volumes of liquids for analysis of particulate or microbiological contamination
- Glass components are manufactured from WHEATON 33 low extractable borosilicate glass that conforms to ASTM E 438 Type I, Class A requirements
- Flasks have a #2 hose connection for 1/4" (6mm) I.D. tubing



With Fritted Glass Support

- Recommended for general filtration
- Includes a coarse porosity (40-60µm) fritted glass support base, 15mL graduated funnel, anodized aluminum clamp, and a No. 5 silicone stopper

Cat. No.	Description	Qty / Case
419325	Complete Unit	1
Component Parts		
419330	Glass Funnel, 25mm, 15mL	1
419334	Aluminum Clamp, 25mm	1
419332	Fritted Glass Support Base, 25mm	1
419336	Silicone Stopper, No. 5	6
Accessories		
419331	Glass Funnel, 25mm, 50mL	1
635229	Filter Flask, 125mL, Graduated, No. 5 Stopper Joint	1

With Stainless Steel Support

- Designed for filtering viscous or proteinaceous solutions or to produce ultraclean filtrate
- Includes a 316 stainless steel support with 120 mesh screen, PTFE support screen gasket, glass support base, 15mL graduated funnel, anodized aluminum clamp and a No. 5 silicone stopper



Cat. No.	Description	Qty / Case
419327	Complete Unit	1
Component Parts		
419330	Glass Funnel, 25mm, 15mL	1
419334	Aluminum Clamp, 25mm	1
419337	Stainless Steel Support Screen, 25mm	1
419338	Support Screen Gasket, 25mm, PTFE	6
419333	Glass Base, 25mm, for S.S. Support	1
419336	Silicone Stopper, No. 5	6
Accessories		
419331	Glass Funnel, 25mm, 50mL	1
635229	Filter Flask, 125mL, Graduated, No. 5 Stopper Joint	1

47mm Filtration Assemblies with No. 8 Stopper Connections

- Designed to handle up to 1000mL of liquid for analysis of particulate or microbiological contamination
- Glass components manufactured from WHEATON 33 low extractable borosilicate glass that conforms to ASTM E 438 Type I, Class A requirements
- Flasks have a #2 hose connection for 1/4" (6mm) I.D. tubing



With Fritted Glass Support

- Recommended for general filtration
- Includes a coarse porosity (40-60µm) fritted glass support base, 300mL graduated funnel, anodized aluminum clamp, and a No. 8 silicone stopper

Cat. No.	Description	Qty / Case
419347	Complete Unit	1
Component Parts		
419350	Glass Funnel, 47mm, 300mL	1
419354	Aluminum Clamp, 47mm	1
419352	Fritted Support Base, 47mm	1
419356	Silicone Stopper, No. 8	6
Accessories		
419410	Glass Funnel, 47mm, 100mL	1
419415	Glass Funnel, 47mm, 500mL	1
419420	Glass Funnel, 47mm, 1000mL	1
635232	Filter Flask, 1L, Graduated, No. 8 Stopper Joint	1
635233	Filter Flask, 2L, Graduated, No. 8 Stopper Joint	1
635245	Filter Flask, 1L, Safety Coated, No. 8 Stopper Joint	1

With PTFE Faced Support Base & Funnel

- Recommended for autoclaving with the filter in place
- PTFE coating prevents the filter from adhering to the ground glass surfaces
- Includes a PTFE faced, coarse porosity (40-60µm) fritted glass support base, a PTFE faced 300mL graduated funnel, an anodized aluminum clamp, and a No. 8 silicone stopper



Cat. No.	Description	Qty / Case
419370	Complete Unit	1
Component Parts		
419374	Glass Funnel, PTFE Faced, 47mm, 300mL	1
419354	Aluminum Clamp, 47mm	1
419372	Fritted Glass Support Base, PTFE faced, 47mm	1
419356	Silicone Stopper, No. 8	6
Accessories		
635232	Filter Flask, 1L, Graduated, No. 8 Stopper Joint	1
635233	Filter Flask, 2L, Graduated, No. 8 Stopper Joint	1
635245	Filter Flask, 1L, Safety Coated, No. 8 Stopper Joint	1

With Stainless Steel Support

- Designed for filtering viscous or proteinaceous solutions or to produce ultraclean filtrate
- Includes a 316 stainless steel support with 120 mesh screen, PTFE support screen gasket, support base, 300mL graduated funnel, anodized clamp and a No. 8 silicone stopper



Cat. No.	Description	Qty / Case
419360	Complete Unit	1
Component Parts		
419350	Glass Funnel, 47mm, 300mL	1
419354	Aluminum Clamp, 47mm	1
419364	Stainless Steel Support Screen, 47mm	1
419366	Support Screen Gasket, 47mm	6
419362	Glass Base, 47mm, for Stainless Steel Support	1
419356	Silicone Stopper, No. 8	6
Accessories		
419410	Glass Funnel, 47mm, 100mL	1
419415	Glass Funnel, 47mm, 500mL	1
419420	Glass Funnel, 47mm, 1000mL	1
635232	Filter Flask, 1L, Graduated, No. 8 Stopper Joint	1
635233	Filter Flask, 2L, Graduated, No. 8 Stopper Joint	1
635245	Filter Flask, 1L, Safety Coated, No. 8 Stopper Joint	1

With Stainless Steel Support

- Designed to filter viscous or proteinaceous solutions or produce an ultra clean filtrate
- Includes a 316 stainless steel support with 120 mesh screen, PTFE support screen gasket, glass support base, 300mL graduated funnel, anodized aluminum clamp and 1L filter flask



Cat. No.	Description	Qty / Case
419390	Complete Unit	1
Component Parts		
419350	Glass Funnel, 47mm, 300mL	1
419354	Aluminum Clamp, 47mm	1
419364	Stainless Steel Support Screen, 47mm	1
419366	Support Screen Gasket, 47mm	6
419392	Glass Base, 47mm, with 40/35 Outer Joint, for Stainless Steel Support	1
635525	Filter Flask, 1L, with 40/35 Inner Joint	1
Accessories		
419410	Glass Funnel, 47mm, 100mL	1
419350	Glass Funnel, 47mm, 300mL	1
419415	Glass Funnel, 47mm, 500mL	1
419420	Glass Funnel, 47mm, 1000mL	1
635527	Filter Flask, 1L, with 40/35 Inner Joint, Safety Coated	1

47mm Filtration Assembly with Standard Taper 40/35 Joint Connection

- Recommended for routine filtration of organic solvents, corrosive liquids and the removal of particulates from HPLC solvents
- Ground glass connection eliminates phthalate contamination that can occur from silicone or neoprene stoppers
- Drip tip on the support bases extends below the hose connection preventing filtrate from entering the vacuum line
- Units have a #2 hose connection for 1/4" (6mm) I.D. flexible tubing
- Glass components manufactured from WHEATON 33 low extractable borosilicate glass that conforms to USP Type I and ASTM E 438 Type I, Class A requirements



With Fritted Glass Support

- Recommended for general filtration
- Includes a coarse porosity (40-60µm) fritted glass support base, graduated funnel, anodized aluminum clamp and 1L filter flask

Cat. No.	Description	Qty / Case
419380	Complete Assembly with 300mL Funnel, 1L Flask	1
419385-47	Complete Assembly with 500mL Funnel, 2L Flask	1
Component Parts		
419350	Glass Funnel, 47mm, 300mL	1
419415	Glass Funnel, 47mm, 500mL	1
419354	Aluminum Clamp, 47mm	1
419382	Fritted Glass Support Base, 47mm, with 40/35 Outer Joint	1
635525	Filter Flask, 1L, with 40/35 Inner Joint	1
635526	Filter Flask, 2L, with 40/35 Inner Joint	1
Accessories		
419410	Glass Funnel, 47mm, 100mL	1
419420	Glass Funnel, 47mm, 1000mL	1
635527	Filter Flask, 1L, with 40/35 Inner Joint, Safety Coated	1

47mm Filtration Assembly with GL45 Thread Connection

- Designed to collect the filtrate directly into a standard laboratory bottle
- Connection to the bottle is made with a polybutylene terephthalate (PBT) cap and a PTFE-faced silicone sealing ring
- Glass components are manufactured from WHEATON 33 low extractable borosilicate glass that conforms to ASTM E 438 Type I, Class A requirements



With Fritted Glass Support

- Recommended for general filtration
- Includes a coarse porosity (40-60 µm) fritted glass support base, 300mL graduated funnel, anodized aluminum clamp, and a 1L reservoir



Cat. No.	Description	Qty / Case
419520-47	Complete Unit	1
Component Parts		
419350	Glass Funnel, 47mm, 300mL	1
419354	Aluminum Clamp, 47mm	1
419502	Filtration Base, 47mm with Vacuum Fitting	1
419501	Quick Disconnect Adapter	12
240755	PBT Cap, 45mm, with 39mm Opening	10
240780	PTFE / Silicone Sealing Ring, for 45mm cap, 26mm I.D.	10

With Stainless Steel Support

- Designed to filter viscous or proteinaceous solutions or produce an ultra clean filtrate
- The assembly comes complete with a 316 stainless steel support with 120 mesh screen, PTFE support screen gasket, glass support base, 300mL graduated funnel, anodized aluminum clamp and 1L reservoir



Cat. No.	Description	Qty / Case
419530-47	Complete Unit	1
Component Parts		
419350	Glass Funnel, 47mm, 300mL	1
419354	Aluminum Clamp, 47mm	1
419364	Stainless Steel Support Screen, 47mm	1
419366	Support Screen Gasket, 47mm	6
419501	Quick Disconnect Adapter	12
240755	PBT Cap, 45mm, with 39mm Opening	10
240780	PTFE / Silicone Sealing Ring, for 45mm Cap, 26mm I.D.	10
WF034590	Filtration Base for Stainless Steel Support 47mm with Vacuum Fitting	1

Filtration Adapter Assembly

- Filtration adapter assembly makes it easier to connect standard 47 and 90mm filtration assemblies with stopper connections to a standard laboratory bottle with a GL45 thread
- Replaces the stopper to make the connection to the bottle
- A GL32 PBT cap with a PTFE faced silicone sealing ring makes the connection to the filtration assembly
- A GL45 PBT cap with PTFE faced silicone sealing ring then makes the connection to the bottle
- Includes a PBT hose connection for use with 1/4" (6mm) I.D. flexible tubing

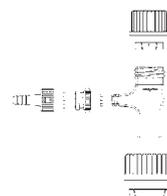

Cat. No.	Description	Qty / Case
419505	Complete Unit	1
Component Parts		
240754	PBT Cap, GL32, with 19mm Opening	10
419506	Glass Adapter Only	1
419501	Quick Disconnect Adapter	12
240755	PBT Cap, GL45, with 39mm Opening	10
240780	PTFE / Silicone Sealing Ring, for 45mm Cap, 26mm I.D.	10

90mm Filtration Assemblies

- Recommended for large sample volumes, liquids with a heavy particulate load and viscous liquids when a high flow rate is required
- Can provide filtration rates up to four times faster than 47mm assemblies due to its larger filter area
- Feature a unique screw collar design for connecting the funnel to the support base providing a more even seal of membrane filter compared to the traditional aluminum clamp
- Glass components are manufactured from WHEATON 33 low extractable borosilicate glass that conforms to ASTM E 438 Type I, Class A requirements
- Flasks have a #2 hose connection for 1/4" (6mm) I.D. tubing

With No. 8 Stopper Connections

- Recommended for routine filtration of aqueous solutions
- No. 8 silicone stopper makes the connection to a standard 1 liter Erlenmeyer-style filtration flask
- Includes a 1L funnel with screw collar, glass support base, filter support (either fritted glass, stainless steel or PTFE) and a No. 8 silicone stopper



Cat. No.	Description	Qty / Case
419450	Complete Unit with Stainless Steel Support	1
419451	Complete Unit with PTFE Support	1
419452	Complete Unit with Removable Glass Frit	1
Component Parts		
419470	Glass Funnel, 90mm, 1L, with Screw Collar	1
WF030089	Glass Frit, 90mm	1
419471	Stainless Steel Support, 90mm	1
265422	PTFE Frit, 90mm	1
419455	Support Base, 90mm	1
419356	Silicone Stopper, No. 8	6
Accessories		
635232	Filter Flask, 1L, Graduated, No. 8 Stopper Joint	1
635245	Filter Flask, 1L, Safety Coated, No. 8 Stopper Joint	1

With Standard Taper 40/35 Joint Connection

- Recommended for routine filtration of organic solvents, corrosive liquids and the removal of particulates from HPLC solvents
- Ground glass connection eliminates phthalate contamination that can occur from silicone or neoprene stoppers
- Drip tip on the support bases extends below the hose connection preventing filtrate from entering the vacuum line
- A filtration flask with a standard taper 40/35 inner joint is required (listed below).



Cat. No.	Description	Qty / Case
419460	90mm Filter Assembly with Stainless Steel Support	1
419461	90mm Filter Assembly with PTFE Support	1
419462	90mm Filter Assembly with Removable Glass Frit	1

Component Parts

419470	Glass Funnel, 90mm, 1L, with Screw Collar	1
WF030089	Glass Frit, 90mm	1
419471	Stainless Steel Support, 90mm	1
265422	PTFE Frit, 90mm	1
419465	Support Base, 90mm	1

Accessories

635525	Filter Flask, 1L, with 40/35 Inner Joint	1
635526	Filter Flask, 2L, with 40/35 Inner Joint	1
635527	Filter Flask, 1L, Safety Coated, with 40/35 Inner Joint	1

Filter Flasks

- Erlenmeyer-style flasks feature heavy-wall glass to provide the mechanical strength needed for vacuum filtration
- Side arms are #2 hose connections that accept standard 1/4" (6mm) I.D. flexible tubing for connection to a vacuum source
- Manufactured from WHEATON 33 low extractable borosilicate glass that conforms to ASTM E 438 Type I, Class A requirements
- Connect a second flask between the filtering flask and the vacuum source to prevent entry of the filtrate into the vacuum source



Cat. No.	Description	Qty / Case
635229	Filter Flask, 125mL, Graduated, No. 5 Stopper Joint	1
635232	Filter Flask, 1L, Graduated, No. 8 Stopper Joint	1
635233	Filter Flask, 2L, Graduated, No. 8 Stopper Joint	1

Filter Flask, Safety Coated

- Filter flask is coated on the outside with WHEATON's plastisol safety coating
- Autoclavable (121°C, 15 psi, 15 minutes)
- Flask has a #2 hose connection that accepts 1/4" (6mm) I.D. flexible tubing for connection to a vacuum source



Cat. No.	Description	Qty / Case
635245	Filter Flask, 1L, Safety Coated, No. 8 Stopper Joint	1





Quality, Value and Reliability for Your Autosampler

Chromatography

WHEATON® Chromatography Vials and accessories are designed for trouble-free operation in most autosamplers. Products include 12 x 32 autosampler vials, headspace vials and shell vials.

12 x 32 autosampler vials are offered in crimp, snap / crimp and screw cap finishes for use in both GC and HPLC applications. Closures are available in variety of colors and septa materials to ensure chemical compatibility with your sample. For micro sampling, DWK Life Sciences has a selection of limited volume inserts.

Headspace vials feature rounded shoulders and bottoms, allowing for even heating and safer operation at high temperatures. Pressure release seals protect the user and equipment by incorporating bridges and scorelines in the aluminum seal. This design allows the internal pressure to be released when 3.0 ± 0.5 bar has been exceeded.

WHEATON® Shell Vials are offered in clear glass, amber glass or polypropylene. Shell vials and snap plug caps can be purchased separately or together as Convenience Packs.

Chromatography

- > Autosampler Vial Sizer..... 93-94
- > Crimp Top Vials..... 86-88
- > Crimp Top / Snap Ring Vials..... 89-90
- > Crimpers & Decappers..... 39-40
- > Headspace Vials..... 92
- > Instrument Compatibility Guide..... 95-96
- > LVI™ Vials..... 83, 88
- > Plastic Vials..... 84, 89
- > Screw Cap Vials..... 81-85
- > Shell Vials..... 91
- > Vial Racks..... 124



ABC Vial™ 12 x 32mm

(Available in Convenience Packs)



W225151 W225153 W225150 W225152

- 40% larger opening improves sample accessibility while reducing autosampler needle damage
- Manufactured from clear and amber Type I borosilicate glass
- Available with or without writing patch

Cat. No.	Size (mL)	Description	Qty / Case
W225150	1.8	Clear	1000
W225151	1.8	Clear with Writing Patch	1000
W225152	1.8	Amber	1000
W225153	1.8	Amber with Writing Patch	1000



225255 225265 225257 225350-631

- Limited volume inserts available separately
- Vials are packaged 100 per shelf pack and 10 packs per case
- 9mm screw thread
- Use with WHEATON ABC Screw Caps

Cat. No.	Size (mL)	Description	Qty / Case
Limited Volume Inserts (Pictured with vial)			
225255	0.10	Glass Insert with Top Spring	200
225265	0.25	Glass Insert with Bottom Spring	100
225257	0.25	Polypropylene Insert w/ Bottom Spring	100
225350-631	0.35	Glass Flat Bottom Insert	1000

ABC Screw Caps



W225330-0103 W225330-0105 W225330-0104 W225330-0107



W225330-0101 W225332-0201 W225338-08 W225334A-04

- Manufactured from polypropylene
- 100/pack with 10 packs/case
- Screw caps are available in natural, black, red, blue, yellow or green polypropylene.

Cat. No.	Description	Shelf Pack	Qty / Case
With White PTFE / Red Silicone Liners			
W225330-01	Natural PP ABC Cap	100	1000
W225330-0101	Black PP ABC Cap	100	1000
W225330-0103	Red PP ABC Cap	100	1000
W225330-0104	Blue PP ABC Cap	100	1000
W225330-0105	Yellow PP ABC Cap	100	1000
W225330-0107	Green PP ABC Cap	100	1000
With Red PTFE / White Silicone Liners			
W225332-02	Natural PP ABC Cap	100	1000
W225332-0201	Black PP ABC Cap	100	1000
W225332-0203	Red PP ABC Cap	100	1000
W225332-0204	Blue PP ABC Cap	100	1000
W225332-0205	Yellow PP ABC Cap	100	1000
W225332-0207	Green PP ABC Cap	100	1000

Cat. No.	Description	Shelf Pack	Qty / Case
With Red PTFE / White Silicone Liners with Slit			
W225338-08	Natural PP ABC Cap	100	1000
W225338-0801	Black PP ABC Cap	100	1000
W225338-0804	Blue PP ABC Cap	100	1000
With Red PTFE / White Silicone / Red PTFE Liners			
W225333-03	Natural PP ABC Cap	100	1000
W225333-0301	Black PP ABC Cap	100	1000
With Blue PTFE / White Silicone Liners			
W225334A-04	Natural PP ABC Cap	100	1000
W225334A-0401	Black PP ABC Cap	100	1000
With Red PTFE Liners			
W225336-06	Natural PP ABC Cap	100	1000
W225336-0601	Black PP ABC Cap	100	1000

ABC Vial™ Convenience Packs (12 x 32mm Screw top with 9mm ABC Screw Cap)

Cat. No.	Vial	Cap Color	Liner	Qty / Case	Vial Cat. No.	Cap Cat. No.
W225154-01	Clear	Natural	White PTFE / Red Silicone	100	W225150	W225330-01
W225154-0101	Clear	Black	White PTFE / Red Silicone	100	W225150	W225330-0101
W225154-0103	Clear	Red	White PTFE / Red Silicone	100	W225150	W225330-0103
W225154-0104	Clear	Blue	White PTFE / Red Silicone	100	W225150	W225330-0104
W225154-0105	Clear	Yellow	White PTFE / Red Silicone	100	W225150	W225330-0105
W225154-0107	Clear	Green	White PTFE / Red Silicone	100	W225150	W225330-0107
W225150-02	Clear	Natural	Red PTFE / White Silicone	100	W225150	W225332-02
W225150-0201	Clear	Black	Red PTFE / White Silicone	100	W225150	W225332-0201
W225150-0204	Clear	Blue	Red PTFE / White Silicone	100	W225150	W225332-0204
W225150-0205	Clear	Yellow	Red PTFE / White Silicone	100	W225150	W225332-0205
W225150-0207	Clear	Green	Red PTFE / White Silicone	100	W225150	W225332-0207
W225150-03	Clear	Natural	Red PTFE / White Silicone / Red PTFE	100	W225150	W225333-03

ABC Vial™ Convenience Packs (12 x 32mm Screw top with 9mm ABC Screw Cap)

Cat. No.	Vial	Cap Color	Liner	Qty / Case	Vial Cat. No.	Cap Cat. No.
W225150-0301	Clear	Black	Red PTFE / White Silicone / Red PTFE	100	W225150	W225333-0301
W225154-04	Clear	Natural	Blue PTFE / White Silicone	100	W225150	W225334A-04
W225154-0401	Clear	Black	Blue PTFE / White Silicone	100	W225150	W225334A-0401
W225150-08	Clear	Natural	Red PTFE / White Silicone with Slit	100	W225150	W225338-08
W225150-0801	Clear	Black	Red PTFE / White Silicone with Slit	100	W225150	W225338-0801
W225150-06	Clear	Natural	Red PTFE	100	W225150	W225336-06
W225150-0601	Clear	Black	Red PTFE	100	W225150	W225336-0601
W225150-0804	Clear	Blue	Red PTFE / White Silicone with Slit	100	W225150	W225338-0804
W225155-01	Clear with Patch	Natural	White PTFE / Red Silicone	100	W225151	W225330-01
W225155-0101	Clear with Patch	Black	White PTFE / Red Silicone	100	W225151	W225330-0101
W225155-0103	Clear with Patch	Red	White PTFE / Red Silicone	100	W225151	W225330-0103
W225155-0104	Clear with Patch	Blue	White PTFE / Red Silicone	100	W225151	W225330-0104
W225155-0105	Clear with Patch	Yellow	White PTFE / Red Silicone	100	W225151	W225330-0105
W225155-0107	Clear with Patch	Green	White PTFE / Red Silicone	100	W225151	W225330-0107
W225151-02	Clear with Patch	Natural	Red PTFE / White Silicone	100	W225151	W225332-02
W225151-0201	Clear with Patch	Black	Red PTFE / White Silicone	100	W225151	W225332-0201
W225151-0204	Clear with Patch	Blue	Red PTFE / White Silicone	100	W225151	W225332-0204
W225151-0205	Clear with Patch	Yellow	Red PTFE / White Silicone	100	W225151	W225332-0205
W225151-0207	Clear with Patch	Green	Red PTFE / White Silicone	100	W225151	W225332-0207
W225151-03	Clear with Patch	Natural	Red PTFE / White Silicone / Red PTFE	100	W225151	W225333-03
W225151-0301	Clear with Patch	Black	Red PTFE / White Silicone / Red PTFE	100	W225151	W225333-0301
W225151-04	Clear with Patch	Natural	Blue PTFE / White Silicone	100	W225151	W225334A-04
W225151-0401	Clear with Patch	Black	Blue PTFE / White Silicone	100	W225151	W225334A-0401
W225151-08	Clear with Patch	Natural	Red PTFE / White Silicone with Slit	100	W225151	W225338-08
W225151-0801	Clear with Patch	Black	Red PTFE / White Silicone with Slit	100	W225151	W225338-0801
W225151-06	Clear with Patch	Natural	Red PTFE	100	W225151	W225336-06
W225151-0601	Clear with Patch	Black	Red PTFE	100	W225151	W225336-0601
W225151-0804	Clear with Patch	Blue	Red PTFE / White Silicone with Slit	100	W225151	W225338-0804
W225156-01	Amber	Natural	White PTFE / Red Silicone	100	W225152	W225330-01
W225156-0101	Amber	Black	White PTFE / Red Silicone	100	W225152	W225330-0101
W225156-0103	Amber	Red	White PTFE / Red Silicone	100	W225152	W225330-0103
W225156-0104	Amber	Blue	White PTFE / Red Silicone	100	W225152	W225330-0104
W225156-0105	Amber	Yellow	White PTFE / Red Silicone	100	W225152	W225330-0105
W225156-0107	Amber	Green	White PTFE / Red Silicone	100	W225152	W225330-0107
W225152-02	Amber	Natural	Red PTFE / White Silicone	100	W225152	W225332-02
W225152-0201	Amber	Black	Red PTFE / White Silicone	100	W225152	W225332-0201
W225152-0204	Amber	Blue	Red PTFE / White Silicone	100	W225152	W225332-0204
W225152-0205	Amber	Yellow	Red PTFE / White Silicone	100	W225152	W225332-0205
W225152-0207	Amber	Green	Red PTFE / White Silicone	100	W225152	W225332-0207
W225152-03	Amber	Natural	Red PTFE / White Silicone / Red PTFE	100	W225152	W225333-03
W225152-0301	Amber	Black	Red PTFE / White Silicone / Red PTFE	100	W225152	W225333-0301
W225152-0804	Amber	Blue	Red PTFE / White Silicone with Slit	100	W225152	W225338-0804
W225156-04	Amber	Natural	Blue PTFE / White Silicone	100	W225152	W225334A-04
W225156-0401	Amber	Black	Blue PTFE / White Silicone	100	W225152	W225334A-0401
W225152-08	Amber	Natural	Red PTFE / White Silicone with Slit	100	W225152	W225338-08
W225152-0801	Amber	Black	Red PTFE / White Silicone with Slit	100	W225152	W225338-0801
W225152-06	Amber	Natural	Red PTFE	100	W225152	W225336-06
W225152-0601	Amber	Black	Red PTFE	100	W225152	W225336-0601
W225157-01	Amber with Patch	Natural	White PTFE / Red Silicone	100	W225153	W225330-01
W225157-0101	Amber with Patch	Black	White PTFE / Red Silicone	100	W225153	W225330-0101
W225157-0103	Amber with Patch	Red	White PTFE / Red Silicone	100	W225153	W225330-0103
W225157-0104	Amber with Patch	Blue	White PTFE / Red Silicone	100	W225153	W225330-0104
W225157-0105	Amber with Patch	Yellow	White PTFE / Red Silicone	100	W225153	W225330-0105
W225157-0107	Amber with Patch	Green	White PTFE / Red Silicone	100	W225153	W225330-0107
W225153-02	Amber with Patch	Natural	Red PTFE / White Silicone	100	W225153	W225332-02
W225153-0201	Amber with Patch	Black	Red PTFE / White Silicone	100	W225153	W225332-0201
W225153-0204	Amber with Patch	Blue	Red PTFE / White Silicone	100	W225153	W225332-0204
W225153-0205	Amber with Patch	Yellow	Red PTFE / White Silicone	100	W225153	W225332-0205
W225153-0207	Amber with Patch	Green	Red PTFE / White Silicone	100	W225153	W225332-0207
W225153-03	Amber with Patch	Natural	Red PTFE / White Silicone / Red PTFE	100	W225153	W225333-03
W225153-0301	Amber with Patch	Black	Red PTFE / White Silicone / Red PTFE	100	W225153	W225333-0301
W225153-0804	Amber with Patch	Blue	Red PTFE / White Silicone with Slit	100	W225153	W225338-0804
W225157-04	Amber with Patch	Natural	Blue PTFE / White Silicone	100	W225153	W225334A-04
W225157-0401	Amber with Patch	Black	Blue PTFE / White Silicone	100	W225153	W225334A-0401
W225153-08	Amber with Patch	Natural	Red PTFE / White Silicone with Slit	100	W225153	W225338-08
W225153-0801	Amber with Patch	Black	Red PTFE / White Silicone with Slit	100	W225153	W225338-0801
W225153-06	Amber with Patch	Natural	Red PTFE	100	W225153	W225336-06
W225153-0601	Amber with Patch	Black	Red PTFE	100	W225153	W225336-0601

LVI™ Vial 12 x 32mm

(Available in Convenience Packs)



- Borosilicate glass vial with 300µL glass limited volume insert
- Insert is fused to vial to prevent needle damage
- Writing patch on all vials
- Purchase vials and caps separately or together in convenience packs
- Use with WHEATON ABC Screw Caps



ABC Screw Caps (See page 81)

Cat. No	Size (mL)	Description	Qty / Case
9mm ABC Screw Cap Vial			
225326	0.3	Clear with Writing Patch	100
225328	0.3	Amber with Writing Patch	100

WHEATON LVI™ Vial Convenience Packs (12x32mm Screw Top with 9mm ABC Screw Cap)

Cat. No.	Vial	Cap Color	Liner	Qty / Case	Vial Cat. No.	Cap Cat. No.
W225327-01	Clear with Patch	Natural	White PTFE / Red Silicone	100	225326	W225330-01
W225327-0101	Clear with Patch	Black	White PTFE / Red Silicone	100	225326	W225330-0101
W225327-0103	Clear with Patch	Red	White PTFE / Red Silicone	100	225326	W225330-0103
W225327-0104	Clear with Patch	Blue	White PTFE / Red Silicone	100	225326	W225330-0104
W225327-0105	Clear with Patch	Yellow	White PTFE / Red Silicone	100	225326	W225330-0105
W225327-0107	Clear with Patch	Green	White PTFE / Red Silicone	100	225326	W225330-0107
W225326-02	Clear with Patch	Natural	Red PTFE / White Silicone	100	225326	W225332-02
W225326-0201	Clear with Patch	Black	Red PTFE / White Silicone	100	225326	W225332-0201
W225326-0204	Clear with Patch	Blue	Red PTFE / White Silicone	100	225326	W225332-0204
W225326-0205	Clear with Patch	Yellow	Red PTFE / White Silicone	100	225326	W225332-0205
W225326-0207	Clear with Patch	Green	Red PTFE / White Silicone	100	225326	W225332-0207
W225326-03	Clear with Patch	Natural	Red PTFE / White Silicone / Red PTFE	100	225326	W225333-03
W225326-0301	Clear with Patch	Black	Red PTFE / White Silicone / Red PTFE	100	225326	W225333-0301
W225326-04	Clear with Patch	Natural	Blue PTFE / White Silicone	100	225326	W225334A-04
W225326-0401	Clear with Patch	Black	Blue PTFE / White Silicone	100	225326	W225334A-0401
W225326-08	Clear with Patch	Natural	Red PTFE / White Silicone with Slit	100	225326	W225338-08
W225326-0801	Clear with Patch	Black	Red PTFE / White Silicone with Slit	100	225326	W225338-0801
W225326-06	Clear with Patch	Natural	Red PTFE	100	225326	W225336-06
W225326-0601	Clear with Patch	Black	Red PTFE	100	225326	W225336-0601
W225329-01	Amber with Patch	Natural	White PTFE / Red Silicone	100	225328	W225330-01
W225329-0101	Amber with Patch	Black	White PTFE / Red Silicone	100	225328	W225330-0101
W225329-0103	Amber with Patch	Red	White PTFE / Red Silicone	100	225328	W225330-0103
W225329-0104	Amber with Patch	Blue	White PTFE / Red Silicone	100	225328	W225330-0104
W225329-0105	Amber with Patch	Yellow	White PTFE / Red Silicone	100	225328	W225330-0105
W225329-0107	Amber with Patch	Green	White PTFE / Red Silicone	100	225328	W225330-0107
W225328-02	Amber with Patch	Natural	Red PTFE / White Silicone	100	225328	W225332-02
W225328-0201	Amber with Patch	Black	Red PTFE / White Silicone	100	225328	W225332-0201
W225328-0204	Amber with Patch	Blue	Red PTFE / White Silicone	100	225328	W225332-0204
W225328-0205	Amber with Patch	Yellow	Red PTFE / White Silicone	100	225328	W225332-0205
W225328-0207	Amber with Patch	Green	Red PTFE / White Silicone	100	225328	W225332-0207
W225328-03	Amber with Patch	Natural	Red PTFE / White Silicone / Red PTFE	100	225328	W225333-03
W225328-0301	Amber with Patch	Black	Red PTFE / White Silicone / Red PTFE	100	225328	W225333-0301
W225328-04	Amber with Patch	Natural	Blue PTFE / White Silicone	100	225328	W225334A-04
W225328-0401	Amber with Patch	Black	Blue PTFE / White Silicone	100	225328	W225334A-0401
W225328-08	Amber with Patch	Natural	Red PTFE / White Silicone with Slit	100	225328	W225338-08
W225328-0801	Amber with Patch	Black	Red PTFE / White Silicone with Slit	100	225328	W225338-0801
W225328-06	Amber with Patch	Natural	Red PTFE	100	225328	W225336-06
W225328-0601	Amber with Patch	Black	Red PTFE	100	225328	W225336-0601

Standard Opening Vial 12 x 32mm



- Manufactured from clear and amber Type I borosilicate glass
- Limited volume inserts available separately
- Screw cap and septa available separately
- Purchase vials and caps separately or together in convenience packs

Cat. No.	Size (mL)	Description	Cap Size	Qty / Case
Standard Opening Vials				
W225900	1.8	Clear Vial	8-425	1000
W225910	1.8	Amber Vial	8-425	1000
Limited Volume Inserts (Pictured with Vial)				
225260	0.10	Glass Insert with Bottom Spring		100
225350-531	0.25	Glass Flat Bottom Insert		1000

Cat. No.	Size	Description	Qty / Case
Preassembled Open Top Caps and Septa			
240602	8-425	Black Polypropylene Cap with PTFE / Silicone Liner	100
242245	8-425	Natural Polypropylene cap with 10 mil Septa	1000
Open Top Caps			
W240506	8-425	Black Phenolic Cap	200
Septa for Open Top Caps			
W240580	8mm	Red PTFE Faced Silicone	100
W240581A	8mm	PTFE Faced Silicone	100
Convenience Packs			
225170	1.8mL	Clear Vial with Unassembled Cap and PTFE / Silicone Septa	240
224950	1.8mL	Clear Vial in Vial File® with Pre-assembled Cap and PTFE / Silicone Septa	60

12 x 32mm Polypropylene Vial with Insert



- Economical alternative to glass
- Manufactured from chemical resistant polypropylene
- Vials are packaged 100 per shelf pack and 10 packs per case
- Conical interior ensures maximum retrieval of contents without the hassle of using removable inserts

Cat. No.	Insert Size	Closure Style	Closure Size	Qty / Case
W225181	300µL	ABC Screw Thread Finish	9mm	1000
225185	300µL	Screw Thread Finish	8-425	1000
W225186	500µL	Screw Thread Finish	10-425	1000
W225237	750µL	Screw Thread Finish	10-425	1000

12 x 32mm Glass / Plastic Vial with 0.1mL Insert



- Thermoplastic polymer outer shell provides safety from breakage
- Type I borosilicate glass insert for contact with sample
- 100µL glass insert volume
- Conical interior ensures maximum retrieval of contents without the hassle of using removable inserts

Cat. No.	Closure Style	Closure Size	Qty / Case
Clear Vial			
225195	Screw Top Finish	8-425	100
Amber Vial			
225205	Screw Top Finish	8-425	100

E-Z Vial® with Step 12 x 32mm



224629 224627 224628 224626 225258 225259

- Innovative design of the vial and limited volume insert enables the insert to be precisely centered inside the vial
- Manufactured from clear and amber Type I borosilicate glass
- Limited volume inserts with step available separately
- Purchase vials and caps separately

Cat. No.	Size (mL)	Description	Cap Size	Qty / Case
E-Z Vials with Step				
224626	1.8	Clear	10-425	1000
224627	1.8	Clear with Writing Patch	10-425	1000
224628	1.8	Amber	10-425	1000
224629	1.8	Amber with Writing Patch	10-425	1000
Limited Volume Inserts (Pictured with Vial)				
225258	0.25	Glass Insert for Vial with Step		100
225259	0.25	Polypropylene Insert for Vial with Step		100

Screw Top Vial 15 x 45mm



224795 224794-01 224795-01 225268

- Manufactured from clear and amber Type I borosilicate glass
- Limited volume inserts available separately
- Purchase vials and caps separately

Cat. No.	Size (mL)	Description	Cap Size	Qty / Case
15 x 45mm Screw Top Vials				
224794-01	4	Clear with Writing Patch	13-425	1000
224795	4	Amber	13-425	1000
224795-01	4	Amber with Writing Patch	13-425	1000
Limited Volume Inserts (Pictured with Vial)				
225268	0.30	Glass Insert with Bottom Spring		100

Caps for Screw Thread Vials



242760

242766

242768

242247

- Pre-assembled black polypropylene (PP) screw cap with septa

Cat. No.	Size (mm)	Description	Qty / Case
Preassembled Open Top Caps and Septa			
242760	10-425	Black PP Cap with ETFE Red Rubber	100
242761	10-425	Black PP Cap with PTFE / Silicone / PTFE	100
242762	10-425	Black PP Cap with PTFE / Silicone	100
242766	10-425	Natural PP cap with 10 mil Septa	1000
242768	13-425	Black PP Cap with PTFE / Silicone Liner	100
242247	13-425	Natural PP cap with 10 mil Septa	1000
Solid Top Caps			
242765	10-425	Black PP Unlined Cap	1000

WHEATON® Vial Racks

WHEATON Vial Racks are offered in a variety of sizes. These racks are manufactured from polypropylene for durability and can be easily cleaned in an automatic washer or autoclaved. WHEATON racks are sturdy and can be stacked, even when the vials are in place.

- > Manufactured from polypropylene
- > Easy to clean and autoclavable
- > Size of the rack depends on vial OD
- > Alpha numeric indexing



See more information on Vial Racks on page 124.

E-Z Vial® 12 x 32mm Crimp Top

(Available in Convenience Packs)



225174 225173 225175 225172

- 40% larger opening improves sample accessibility while reducing autosampler needle damage
- Manufactured from Type I borosilicate glass
- Purchase vials and caps separately or together in convenience packs
- Available with or without writing patch

Cat. No.	Size (mL)	Description	Qty / Case
E-Z Vial			
225175	1.8	Clear	1000
225174	1.8	Clear w/ Writing patch	1000
225172	1.8	Amber	1000
225173	1.8	Amber w/ Writing patch	1000

Standard Opening Crimp Vial 12 x 32mm



223692 223682 223692-01 223682-01

- Original design used in most autosamplers
- Manufactured from Type I borosilicate glass
- Available with or without writing patch
- Limited volume inserts available separately

Cat. No.	Size (mL)	Description	Qty / Case
Standard Crimp Vial			
223682	1.5	Clear	1000
223682-01	1.5	Clear, with Writing Patch	1000
223692	1.5	Amber	1000
223692-01	1.5	Amber, with Writing Patch	1000

Limited Volume Inserts

(For E-Z Vials® with Wide Opening)



225350-631 225265 225255 225257

Cat. No.	Size (mL)	Description	Qty / Case
Limited Volume Inserts (Pictured with Vial)			
225255	0.10	Glass Insert with Top Spring	200
225265	0.25	Glass Insert with Bottom Spring	100
225257	0.25	Polypropylene Insert w/ Bottom Spring	100
225350-631	0.35	Glass Flat Bottom Insert	1000

Limited Volume Inserts

(For Standard Opening Vials)



225350-531 225260

Cat. No.	Size (mL)	Description	Qty / Case
Limited Volume Insert (Pictured with Vial)			
225260	0.10	Glass Insert with Bottom Spring	100
225350-531	0.25	Glass Flat Bottom Insert	1000

E-Z Seals™ 11mm Aluminum



- For use with 12 x 32mm crimp top vials
- Large target diameter
- Seals available in 4 colors
- Choice of liner

Cat. No.	Description	Shelf Pack	Qty / Case
With Natural PTFE / Red Silicone			
224211-01	Natural Aluminum	100	1000
224211-05	Blue Aluminum	100	1000
224211-06	Red Aluminum	100	1000
224211-07	Green Aluminum	100	1000
With Natural PTFE / Natural Silicone Liner			
224219-01	Natural Aluminum	100	1000
224219-05	Blue Aluminum	100	1000
224219-06	Red Aluminum	100	1000
224219-07	Green Aluminum	100	1000
With Red PTFE / Natural Silicone / Red PTFE Liner			
224231-01	Natural Aluminum	100	1000
224231-05	Blue Aluminum	100	1000
224231-06	Red Aluminum	100	1000
224231-07	Green Aluminum	100	1000
With PTFE / Gray Butyl Liner			
224235-01	Natural Aluminum	100	1000

E-Z Vial® 12 x 32mm Crimp Top Convenience Packs (12 x 32mm Crimp Top Vial with 11mm E-Z Seal™)

Cat. No.	Vial	Seal Color	Septum	Qty / Case	Vial Cat. No.	Seal Cat. No.
W225175-01	Clear	Natural	PTFE / Red Rubber	100	225175	224211-01
W225175-0103	Clear	Red	PTFE / Red Rubber	100	225175	224211-05
W225175-0104	Clear	Blue	PTFE / Red Rubber	100	225175	224211-06
W225175-0107	Clear	Green	PTFE / Red Rubber	100	225175	224211-07
W225175-02	Clear	Natural	PTFE / Silicone	100	225175	224219-01
W225175-0203	Clear	Red	PTFE / Silicone	100	225175	224219-05
W225175-0204	Clear	Blue	PTFE / Silicone	100	225175	224219-06
W225175-0207	Clear	Green	PTFE / Silicone	100	225175	224219-07
W225175-0303	Clear	Red	PTFE / Silicone / PTFE	100	225175	224231-05
W225175-0304	Clear	Blue	PTFE / Silicone / PTFE	100	225175	224231-06
W225174-01	Clear with Patch	Natural	PTFE / Red Rubber	100	225174	224211-01
W225174-0103	Clear with Patch	Red	PTFE / Red Rubber	100	225174	224211-05
W225174-0104	Clear with Patch	Blue	PTFE / Red Rubber	100	225174	224211-06
W225174-0107	Clear with Patch	Green	PTFE / Red Rubber	100	225174	224211-07
W225174-02	Clear with Patch	Natural	PTFE / Silicone	100	225174	224219-01
W225174-0203	Clear with Patch	Red	PTFE / Silicone	100	225174	224219-05
W225174-0204	Clear with Patch	Blue	PTFE / Silicone	100	225174	224219-06
W225174-0207	Clear with Patch	Green	PTFE / Silicone	100	225174	224219-07
W225174-0303	Clear with Patch	Red	PTFE / Silicone / PTFE	100	225174	224231-05
W225174-0304	Clear with Patch	Blue	PTFE / Silicone / PTFE	100	225174	224231-06
W225172-01	Amber	Natural	PTFE / Red Rubber	100	225172	224211-01
W225172-0103	Amber	Red	PTFE / Red Rubber	100	225172	224211-05
W225172-0104	Amber	Blue	PTFE / Red Rubber	100	225172	224211-06
W225172-0107	Amber	Green	PTFE / Red Rubber	100	225172	224211-07
W225172-02	Amber	Natural	PTFE / Silicone	100	225172	224219-01
W225172-0203	Amber	Red	PTFE / Silicone	100	225172	224219-05
W225172-0204	Amber	Blue	PTFE / Silicone	100	225172	224219-06
W225172-0207	Amber	Green	PTFE / Silicone	100	225172	224219-07
W225172-0303	Amber	Red	PTFE / Silicone / PTFE	100	225172	224231-05
W225172-0304	Amber	Blue	PTFE / Silicone / PTFE	100	225172	224231-06
W225173-01	Amber with Patch	Natural	PTFE / Red Rubber	100	225173	224211-01
W225173-0103	Amber with Patch	Red	PTFE / Red Rubber	100	225173	224211-05
W225173-0104	Amber with Patch	Blue	PTFE / Red Rubber	100	225173	224211-06
W225173-0107	Amber with Patch	Green	PTFE / Red Rubber	100	225173	224211-07
W225173-02	Amber with Patch	Natural	PTFE / Silicone	100	225173	224219-01
W225173-0203	Amber with Patch	Red	PTFE / Silicone	100	225173	224219-05
W225173-0204	Amber with Patch	Blue	PTFE / Silicone	100	225173	224219-06
W225173-0207	Amber with Patch	Green	PTFE / Silicone	100	225173	224219-07
W225173-0303	Amber with Patch	Red	PTFE / Silicone / PTFE	100	225173	224231-05
W225173-0304	Amber with Patch	Blue	PTFE / Silicone / PTFE	100	225173	224231-06

LVI™ Vials 12 x 32mm Crimp Top



225221-01



225220-01



- Borosilicate glass vial with 300µL glass limited volume insert
- Limited Volume Insert is fused to vial which prevents needle damage
- Writing patch on all vials
- Purchase vials and caps separately or together in convenience packs

Cat. No.	Size (mL)	Description	Qty / Case
LVI Vial			
225220-01	0.3	Clear with Writing Patch	100
225221-01	0.3	Amber with Writing Patch	100

E-Z Seals™ 11mm Aluminum (See page 86)

LVI™ Vials 12 x 32mm Crimp Top Convenience Packs

- 12 x 32mm LVI™ Vial & 11mm Aluminum E-Z Seal™
- Choose clear or amber glass vial
- Writing patch on all vials

Cat. No.	Vial	Seal Color	Septum	Qty / Case	Vial Cat. No.	Seal Cat. No.
W225223-01	Clear with Patch	Natural	PTFE / Red Rubber	100	225220-01	224211-01
W225225-01	Amber with Patch	Natural	PTFE / Red Rubber	100	225221-01	224211-01



E-Z Vial® with Snap Ring 12 x 32mm

(Available in Convenience Packs)



- Snap ring vials eliminate the need for crimping and decapping tools
- Vials accept snap cap or 11mm aluminum seal
- 40% larger opening improves sample accessibility while reducing auto sampler needle damage
- Clear or amber Type I borosilicate glass

Cat. No.	Size (mL)	Description	Qty / Case
E-Z Vial with Snap Ring			
225179	1.8	Clear	1000
225179-01	1.8	Clear with Writing Patch	1000
225179-02	1.8	Amber	1000
225179-03	1.8	Amber with Writing Patch	1000

11mm Snap Caps



- Eliminate the need for crimping and decapping tools
- Fits the WHEATON E-Z Vials® with Snap Ring top
- Manufactured from polyethylene
- Choose from 5 colored caps and a variety of septa

Cat. No.	Description	Shelf Pack	Qty / Case
With PTFE / Red Rubber Septa			
242786	Natural Cap	100	1000
With PTFE / Silicone Septa			
242775	Natural Cap with Cross Slit	100	1000
242776	Natural Cap	100	1000
242776-01	Blue Cap	100	1000
242776-02	Green Cap	100	1000
242776-04	Red Cap	100	1000
242776-05	Yellow Cap	100	1000
With Red PTFE / Silicone / Red PTFE Septa			
242772	Natural Cap	100	1000
242772-01	Blue Cap	100	1000
242772-02	Green Cap	100	1000
242772-04	Red Cap	100	1000
242772-05	Yellow Cap	100	1000
242772-06	Natural Cap with Star Slit	100	1000
With PTFE Septa			
242782	Natural Cap	100	1000

Limited Volume Inserts

(For Snap Ring Vials)



- Available with or without writing patch
- Glass and polypropylene limited volume inserts
- Purchase vials and snap caps separately or together in convenience packs
- Packaged in shrink-wrapped trays of 100 for convenience and cleanliness

Cat. No.	Size (mL)	Description	Qty / Case
Limited Volume Inserts (Pictured with Vial)			
225255	0.10	Glass Insert with Top Spring	200
225265	0.25	Glass Insert with Bottom Spring	100
225257	0.25	Polypropylene Insert w/ Bottom Spring	100
225350-631	0.35	Glass Flat Bottom Insert	1000

12 x 32mm Polypropylene Vial with Insert



- Economical alternative to glass
- Manufactured from chemical resistant polypropylene
- Vials are packaged 100 per shelf pack and 10 packs per case
- Conical interior ensures maximum retrieval of contents without the hassle of removable inserts

Cat. No.	Insert Size	Closure Style	Closure Size	Qty / Case
225180	300µL	Snap / Crimp Finish	11mm	1000
W225187	500µL	Snap / Crimp Finish	11mm	1000
225235	750µL	Snap / Crimp Finish	11mm	1000

12 x 32mm Glass / Plastic Vial with 0.1mL Insert



- Thermoplastic polymer outer shell provides safety from breakage
- Type I borosilicate glass insert for contact with sample
- 100µL glass insert volume
- Conical interior ensures maximum retrieval of contents without the hassle of removable inserts

Cat. No.	Closure Style	Color	Closure Size	Qty / Case
225190	Snap / Crimp Finish	Clear	11mm	100
225200	Snap / Crimp Finish	Amber	11mm	100

E-Z Vial® with Snap Ring Convenience packs (12 x 32mm Snap Top with 11mm Snap Cap)

Cat. No.	Vial	Cap Color	Septum	Qty / Case	Vial Cat. No.	Cap Cat. No.
W224620-01	Clear	Natural	PTFE / Red Rubber	100	225179	242786
W224620-02	Clear	Natural	PTFE / Silicone	100	225179	242776
W224620-0203	Clear	Red	PTFE / Silicone	100	225179	242776-04
W224620-0204	Clear	Blue	PTFE / Silicone	100	225179	242776-01
W224620-0205	Clear	Yellow	PTFE / Silicone	100	225179	242776-05
W224620-0207	Clear	Green	PTFE / Silicone	100	225179	242776-02
W224620-03	Clear	Natural	PTFE / Silicone / PTFE	100	225179	242772
W224620-0303	Clear	Red	PTFE / Silicone / PTFE	100	225179	242772-04
W224620-0304	Clear	Blue	PTFE / Silicone / PTFE	100	225179	242772-01
W224620-0305	Clear	Yellow	PTFE / Silicone / PTFE	100	225179	242772-05
W224620-0307	Clear	Green	PTFE / Silicone / PTFE	100	225179	242772-02
W224621-01	Clear with Patch	Natural	PTFE / Red Rubber	100	225179-01	242786
W224621-02	Clear with Patch	Natural	PTFE / Silicone	100	225179-01	242776
W224621-0203	Clear with Patch	Red	PTFE / Silicone	100	225179-01	242776-04
W224621-0204	Clear with Patch	Blue	PTFE / Silicone	100	225179-01	242776-01
W224621-0205	Clear with Patch	Yellow	PTFE / Silicone	100	225179-01	242776-05
W224621-0207	Clear with Patch	Green	PTFE / Silicone	100	225179-01	242776-02
W224621-03	Clear with Patch	Natural	PTFE / Silicone / PTFE	100	225179-01	242772
W224621-0303	Clear with Patch	Red	PTFE / Silicone / PTFE	100	225179-01	242772-04
W224621-0304	Clear with Patch	Blue	PTFE / Silicone / PTFE	100	225179-01	242772-01
W224621-0305	Clear with Patch	Yellow	PTFE / Silicone / PTFE	100	225179-01	242772-05
W224621-0307	Clear with Patch	Green	PTFE / Silicone / PTFE	100	225179-01	242772-02
W224622-01	Amber	Natural	PTFE / Red Rubber	100	225179-02	242786
W224622-02	Amber	Natural	PTFE / Silicone	100	225179-02	242776
W224622-0203	Amber	Red	PTFE / Silicone	100	225179-02	242776-04
W224622-0204	Amber	Blue	PTFE / Silicone	100	225179-02	242776-01
W224622-0205	Amber	Yellow	PTFE / Silicone	100	225179-02	242776-05
W224622-0207	Amber	Green	PTFE / Silicone	100	225179-02	242776-02
W224622-03	Amber	Natural	PTFE / Silicone / PTFE	100	225179-02	242772
W224622-0303	Amber	Red	PTFE / Silicone / PTFE	100	225179-02	242772-04
W224622-0304	Amber	Blue	PTFE / Silicone / PTFE	100	225179-02	242772-01
W224622-0305	Amber	Yellow	PTFE / Silicone / PTFE	100	225179-02	242772-05
W224622-0307	Amber	Green	PTFE / Silicone / PTFE	100	225179-02	242772-02
W224623-01	Amber with Patch	Natural	PTFE / Red Rubber	100	225179-03	242786
W224623-02	Amber with Patch	Natural	PTFE / Silicone	100	225179-03	242776
W224623-0203	Amber with Patch	Red	PTFE / Silicone	100	225179-03	242776-04
W224623-0204	Amber with Patch	Blue	PTFE / Silicone	100	225179-03	242776-01
W224623-0205	Amber with Patch	Yellow	PTFE / Silicone	100	225179-03	242776-05
W224623-0207	Amber with Patch	Green	PTFE / Silicone	100	225179-03	242776-02
W224623-03	Amber with Patch	Natural	PTFE / Silicone / PTFE	100	225179-03	242772
W224623-0303	Amber with Patch	Red	PTFE / Silicone / PTFE	100	225179-03	242772-04
W224623-0304	Amber with Patch	Blue	PTFE / Silicone / PTFE	100	225179-03	242772-01
W224623-0305	Amber with Patch	Yellow	PTFE / Silicone / PTFE	100	225179-03	242772-05
W224623-0307	Amber with Patch	Green	PTFE / Silicone / PTFE	100	225179-03	242772-02

Shell Vial 8 x 40mm

(Available in Convenience Packs)



- Can be used in Waters WISP™ 96-position autosampler
- Choice of borosilicate glass or polypropylene
- 0.15 or 0.20mL limited volume insert
- Snap plug closures available in 5 colors
- Purchase vials and caps separately or together in convenience packs
- Polyethylene snap plug caps feature a starburst top for easier needle penetration

Cat. No.	Size (mL)	Description	Qty / Case
8 x 40mm Shell Vial			
W225243	1	Glass Shell Vial, Clear	1000
225241	1	Polypropylene Shell Vial	1000
225242	0.7	Polypropylene Limited Volume Shell Vial	1000
Limited Volume Insert (Pictured with Vial)			
W225251	0.15	Glass Insert with Bottom Spring	100
Convenience Pack			
W225244	1	Glass Shell Vial with 8mm Snap Plug Cap (Cat. No. 242800)	1000

Snap Plug Caps (For 8 x 40mm Shell Vials)



Cat. No.	Size (mm)	Description	Qty / Case
242800	8	Natural	1000
242802	8	Red	1000
242804	8	Blue	1000
242806	8	Green	1000
242808	8	Yellow	1000

Shell Vial 12 x 32mm

(Available in Convenience Packs)



- Choice of borosilicate glass or polypropylene
- Snap plug closure available in natural polyethylene
- Purchase vials and caps separately or together in convenience packs
- Polyethylene snap plug caps feature a starburst top for easier needle penetration

Cat. No.	Size (mL)	Description	Qty / Case
12 x 32 Shell Vial			
225120	2	Glass Shell Vial, Clear	1000
225121	2	Glass Shell Vial, Amber	1000
225124	2	Polypropylene Shell Vial	1000
Snap Plug Cap			
242810	12mm	Natural	1000
Convenience Pack			
W225122	2	Glass Shell Vial, Clear w/ Plug Cap	1000
W225123	2	Glass Shell Vial, Amber w/ Plug Cap	1000
W225125	2	Polypropylene Shell Vial w/ Plug Cap	1000

Shell Vial 15 x 45mm

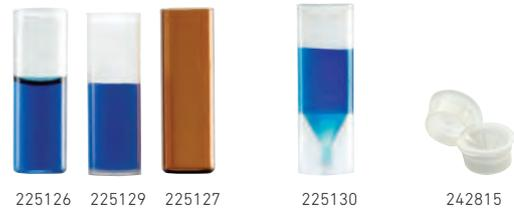

- Choice of borosilicate glass or polypropylene
- Snap plug closure available in low density polyethylene
- Purchase vials and snap plug caps separately
- Polyethylene snap plug caps feature a starburst top for easier needle penetration

Cat. No.	Size (mL)	Description	Qty / Case
15 x 45mm Shell Vial			
225126	4	Glass Shell Vial, Clear	1000
225127	4	Glass Shell Vial, Amber	1000
225129	4	Polypropylene Shell Vial	1000
225130	3	Polypropylene Limited Volume Shell Vial	1000
15mm Snap Plug Cap			
242815	—	Natural	1000

Headspace Vials, Crimp Top



- Manufactured from clear Type I borosilicate glass
- Accept 20mm aluminum seals
- Variety of aluminum seal styles and septa materials available
- Purchase vials separately or together with seals in convenience packs

Cat. No.	Size (mL)	Dia. x H (mm)	Qty / Case
Rounded Bottom, Beveled Finish			
W225277	6	22 x 38	100
W225278	10	23 x 46	100
W225280	20	23 x 75	100
Rounded Bottom, Standard Finish, Long Neck			
W225279	20	23 x 75.5	100
Flat Bottom, Beveled Finish			
W225281	6	22 x 38	100
W225282	10	23 x 46	100
W225283	20	23 x 75	100

Headspace Crimp Seals



- Pressure release seals feature score lines that allow for internal pressure release when 3.0 ± 0.5 bar has been exceeded

Cat. No.	Size (mm)	Seal Color	Description	Qty / Case
Standard				
W224221	20	Natural	PTFE / Silicone Septa	100
W224224	20	Natural	PTFE / Butyl Septa	100
W224225	20	Natural	PTFE / Gray Butyl Molded Septa	100
Pressure Release				
W224215	20	Natural	PTFE / Silicone Septa	100
W224216	20	Natural	PTFE / Gray Butyl Molded Septa	100
W224217	20	Natural	Aluminum Faced Silicone Septa	100
Magnetic				
W224223	20	Gold	PTFE / Silicone Septa	100

Aluminum Seal and Septa Components



Cat. No.	Size (mm)	Description	Qty / Case
224178-01	20	Open Top, Unlined Aluminum Seal	1000
224183-01	20	Center Disc Tear-Out, Unlined Aluminum Seal	1000
W224100-181	20	Gray Butyl Stopper	1000
W224173	20	PTFE / Silicone Septa	100
224168	20	PTFE / Gray Butyl Molded Septa	100

Headspace Vials, Screw Thread



- Manufactured from clear Type I borosilicate glass
- Screw thread finish eliminates the need for crimping tools
- Accepts 18mm screw thread closures with septa

Cat. No.	Size (mL)	Dia. x H. (mm)	Qty / Case
Clear			
W225284	10	23 x 46	100
W225286	20	23 x 75.5	100
Amber			
W225285	10	23 x 46	100
W225287	20	23 x 75.5	100

Screw Thread Headspace Closures



- Magnetic screw caps allow for use in magnetic transport autosamplers

Cat. No.	Size (mm)	Description	Qty / Case
W224218	18	White PTFE / Transparent Blue Silicone Septa	100
W224219	18	PTFE / Butyl Septa	100
W224220	18	Red PTFE / White Silicone Septa	100

Convenience Packs

- Each convenience pack includes 100 rounded bottom, beveled finish vials and 100 20mm pressure release crimp seals
- Pressure release seals release pressure when 3.0 ± 0.5 bar has been exceeded
- Seals are natural colored



Cat. No.	Vial Size (mL)	Description	Qty / Case
W225278-01	10	PTFE / Silicone Septa	100
W225278-02	10	PTFE / Gray Butyl Molded Septa	100
W225278-03	10	Aluminum Faced Silicone Septa	100
W225280-01	20	PTFE / Silicone Septa	100
W225280-02	20	PTFE / Gray Butyl Molded Septa	100
W225280-03	20	Aluminum Faced Silicone Septa	100

Screw Cap Vials

12 x 32mm

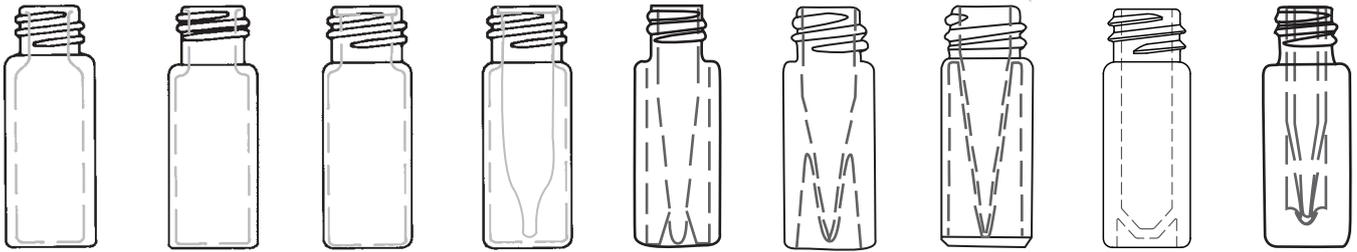
W225900 (Clear)
W225910 (Amber)W225150 (Clear)
W225151 (Clear)
W225152 (Amber)
W225153 (Amber)224626 (Clear)
224627 (Clear)
224628 (Amber)
224629 (Amber)225326 (Clear)
225328 (Amber)

225185 (Clear)

W225186 (Clear)

W225181 (Clear)

W225237 (Clear)

225195 (Clear)
225205 (Amber)

Crimp Top Vials

12 x 32mm

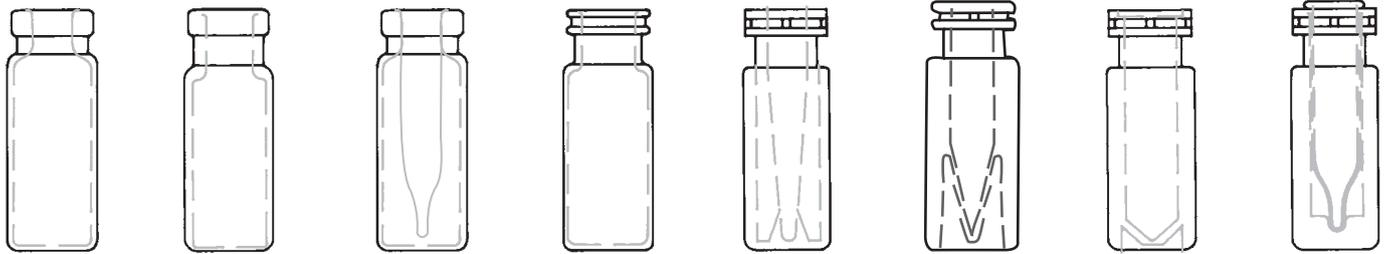
223682 (Clear)
223682-01 (Clear)
223692 (Amber)
223692-01 (Amber)225172 (Amber)
225173 (Amber)
225174 (Clear)
225175 (Clear)225220-01 (Clear)
225221-01 (Amber)225179 (Clear)
225179-01 (Clear)
225179-02 (Amber)
225179-03 (Amber)

225180 (Clear)

W225187 (Clear)

225235 (Clear)

225190 (Clear)
225200 (Amber)

Snap Ring Vials

12 x 32mm

Limited Volume Inserts

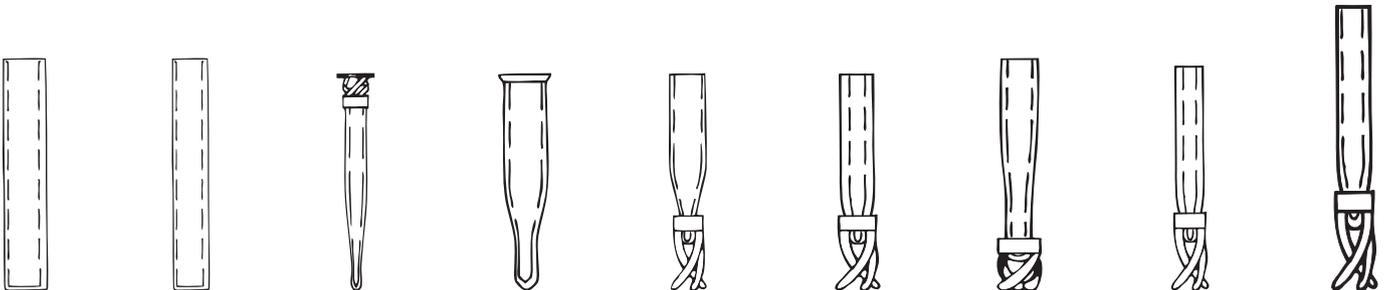
225350-631
Flat Bottom
Wide Open-
ing225350-531
Flat Bottom
Standard
Opening225255
Top Spring
Wide Open-
ing225258
225259
With
Step225260
Bottom Spring
Standard
Opening225265
Bottom
Spring
Wide Open-
ing225257
Bottom
Spring
Wide Open-
ingW225251
Bottom
Spring225268
Bottom
Spring

Screw Cap Vials

15 x 45mm

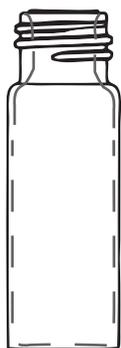

224794-01 (Clear)
224795 (Amber)
224795-01 (Amber)

Shell Vials

8 x 40mm



225242 (Clear)



W225243 (Clear)
225241 (Clear)

12 x 32mm

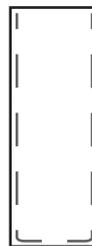

225120 (Clear)
225121 (Amber)
225124 (Clear)

15 x 45mm



225126 (Clear)
225127 (Amber)
225129 (Clear)



225130 (Clear)

Headspace Vials



225277 (Clear)

225278 (Clear)

225280 (Clear)

985688 (Clear)

Color Codes:

RED - Glass Vials BLUE - Plastic Vials GREEN - Glass /
Plastic Vials

WHEATON Chromatography Vials and inserts are shown at exact size.
The catalog numbers are color coded by vial material.

Vial Size (mm)	8 x 40	12 x 32	12 x 32	12 x 32	12 x 32	12 x 32	12 x 32	12 x 32	15 x 45	15 x 45
Vial Type	Shell Vial	Shell Vial	Crimp Finish	Snap / Crimp	ABC 9mm Screw Thread	8-425 Screw Thread	10-425 Screw Thread	13-425 Screw Thread	Shell Vial	Shell Vial
Mfr. & Model										
Agilent GC										
CTC Combi PAL / GC PAL—	—	—	•	•	•	—	—	—	—	—
7890A	—	—	•	•	•	—	—	—	—	—
7673 / 7683	—	—	•	•	•	—	—	—	—	—
7670A / 7671A	—	—	•	•	•	—	—	—	—	—
6820 / 6850 / 6890N	—	—	•	•	•	—	•	•	—	—
5975C	—	—	•	•	•	—	—	—	—	—
5890 / 7985A / 6890	—	—	•	•	•	—	—	—	—	—
Agilent LC										
1200 Series	—	—	•	•	•	—	—	—	—	—
1100 Series Prep	—	—	•	•	•	—	—	—	—	—
1100 Series Standard	—	—	•	•	•	—	—	—	—	—
1050	—	—	•	•	•	•	—	—	—	—
1090	—	—	•	•	•	—	—	—	—	—
Alcott Chrom										
719D	—	—	•	•	•	•	•	—	—	—
718AL	—	—	•	•	•	•	•	—	—	—
728	—	—	—	—	—	—	—	—	—	—
Alltech Associates										
580	—	—	•	•	•	•	•	•	—	—
570	—	—	•	•	•	•	•	•	—	—
Amersham Pharmacia Biotech (Division of Applied Biosystems Group)										
2157-010	—	—	•	•	—	•	—	—	—	—
2457-020	—	—	—	—	—	—	—	—	—	—
Beckman Coulter										
501 / 502 / 507	—	—	—	—	—	•	•	—	—	—
504	—	—	—	—	—	—	—	•	—	—
508	—	—	—	—	—	—	—	•	—	—
Bruker / Daltronics										
LC 51	—	—	—	—	—	—	—	•	•	—
CE Instruments (Division of Thermo Fisher Scientific)										
42 Place Tray	—	—	•	•	—	—	—	•	•	—
60 Place Tray	—	—	—	—	—	—	—	—	—	—
AS105 Tray	—	—	•	•	—	—	—	—	—	—
AS 200 Tray	—	—	—	—	—	—	—	—	—	—
Dani										
ALS 86.80	—	—	•	•	•	•	—	—	—	—
ALS 39.80	—	—	•	•	•	•	—	—	—	—
Dionex / Gynkotek										
Gina	—	—	•	•	—	•	—	—	—	—
ALI-100	—	—	—	•	•	•	—	—	—	—
AS 509	—	—	—	•	•	•	—	—	—	—
Dynatech / Precision										
WPS-3000	—	—	•	•	•	•	—	—	—	—
42 Place Tray	—	—	•	•	•	•	—	—	—	—
60 Place Tray	—	—	—	—	—	—	—	—	—	—
LC2000	—	—	—	—	—	•	—	—	—	—
231 XL, 232 XL	—	—	•	•	•	•	—	—	—	—
ESA / LC Packing										
Model 542	—	—	•	•	•	•	—	—	—	—
Midas	—	—	•	•	•	•	—	—	—	—
Gilson										
233 Sample Changer	—	—	—	—	—	—	—	—	—	—
231 XL / 232XL / 233XL	—	—	•	•	•	•	—	—	—	—
GX-271 / 281	—	—	•	•	•	•	—	—	—	—
Aspec XL	—	—	•	•	•	•	—	—	—	—
Hitachi										
L2200	—	—	•	•	•	•	—	—	—	—
L7250	—	—	•	•	•	•	—	—	—	—
L8800	—	—	—	•	•	—	—	—	—	—
L7200	•	—	—	—	•	•	—	•	•	—
AS-2000	—	—	•	•	•	•	—	—	—	—
AS-4000	—	—	•	•	•	•	—	—	—	—

Vial Size (mm)	8 x 40	12 x 32	12 x 32	12 x 32	12 x 32	12 x 32	12 x 32	12 x 32	15 x 45	15 x 45
Vial Type	Shell Vial	Shell Vial	Crimp Finish	Snap / Crimp	ABC 9mm Screw Thread	8-425 Screw Thread	10-425 Screw Thread	13-425 Screw Thread	Shell Vial	Shell Vial
Mfr. & Model										
Jasco										
AS-2050 / 2055/2057	—	—	•	•	•	•	—	—	—	—
AS-2059	—	—	•	•	•	•	—	—	—	—
AS-1555 / 1555-10	—	—	•	•	•	•	—	—	—	—
AS-1559	—	—	•	•	•	•	—	—	—	—
851-AS, AS-900	—	—	•	•	•	•	—	—	—	—
LC 800 / 900 Series	—	—	—	—	—	•	—	—	—	—
Leap Technologies										
CTC DI PAL	—	—	•	•	•	•	—	—	—	—
CTC Combi PAL	—	—	•	•	•	•	—	—	—	—
CTC A200E	—	—	•	•	•	•	—	—	—	—
CTC HTS PAL	—	—	•	•	•	•	—	•	—	—
CTC HTS Twin PAL	—	—	•	•	•	•	—	—	—	—
CTC HTC PAL	—	—	•	•	•	•	—	—	—	—
CTC LC mini PAL	—	—	•	•	•	•	—	—	—	—
CTC A2000S	—	—	•	•	•	•	—	—	—	—
A200LC	—	—	•	•	—	—	—	—	—	—
Perkin Elmer										
Claris 500, 600	—	—	•	•	•	•	—	—	—	—
Autosystem	—	—	•	•	•	•	—	—	—	—
Autosystem XL	—	—	•	•	•	•	—	—	—	—
Series 200	—	—	•	•	•	•	—	—	—	—
Integral 4000	—	—	•	—	—	—	—	—	—	—
ISS 100, ISS 200	—	—	•	•	•	•	—	—	—	—
LC 600 42 Place Tray	—	—	•	•	•	—	—	—	—	—
Phillips / Pye UNICAM										
4710	—	—	•	•	—	•	—	—	—	—
4700LC-GC / S4/S8	—	—	—	—	—	—	—	—	—	—
4247	—	—	•	•	—	•	—	—	—	—
C-XP	—	—	—	—	—	—	—	•	—	•
Shimadzu GC										
AOC-20i / AOC-20s	—	—	—	—	—	•	•	•	•	•
AOC-8B	—	—	—	—	—	•	—	—	—	—
AOC-5000	•	—	—	—	—	•	—	—	—	—
AOC-14 / AOC-17	—	—	—	—	—	•	—	—	•	•
Shimadzu HPLC										
SIL-HTa / SIL-HTc	•	—	—	•	•	•	•	•	•	—
SIL-10ADV	•	—	—	•	•	•	•	•	•	—
SIL-10A / SIL-10Ai / SIL-10Ap	•	—	—	•	•	•	•	•	•	—
SIL-6B / SIL-9A / SIL-8A	—	—	—	—	—	•	—	—	—	—
SIL-10AD	—	—	—	•	•	•	•	•	—	—
Promis	•	—	•	•	•	•	—	—	—	—
Spark Holland										
Reliance	—	—	•	•	•	•	—	—	—	—
Midas	—	—	•	•	•	•	—	—	—	—
Marathon	•	—	•	•	•	•	—	—	—	—
Triathon	•	—	•	—	—	•	—	—	—	—
Thermo Scientific (Division of Thermo Fisher Scientific)										
AS1000 / AS3000 / AS3500	—	—	•	•	—	•	—	—	—	—
TriPlus AS / HS / DUO	—	—	•	•	—	•	—	—	—	—
Surveyor Plus / Plus Lite	—	—	•	•	—	•	—	—	—	—
Accela	—	—	•	•	—	•	—	—	—	—
8875 / 8880	—	—	•	•	—	•	—	—	—	—
Varian GC										
CP-8400 / CP-8410	—	—	•	•	•	•	—	—	—	—
8200CX	—	—	—	—	•	—	—	—	—	—
Ultra GC / MS	—	—	—	—	•	—	—	—	—	—
8100 / 8200	—	—	•	•	•	•	•	—	—	—
Varian LC										
9100 / 9090 / 9095	—	—	•	•	—	•	—	—	—	—
ProStar 400 / 410	—	—	—	•	•	—	—	—	—	—
ProStar 420 / 430	—	—	—	•	•	—	—	—	—	—
Marathon	•	—	•	•	•	•	—	—	—	—
Waters LC										
Acquity	—	—	—	•	•	•	•	—	—	—
Alliance	•	—	—	•	•	—	—	•	—	•
Breeze	•	—	—	•	•	•	—	•	—	•
717 Plus	•	—	—	•	•	•	—	•	—	•
2700 Sample Manager	—	—	—	•	•	—	—	—	—	—
710 / 712 / 715	—	—	•	—	—	—	—	•	—	•



Quality Products for Environmental Sampling & Analysis

Environmental

Within the WHEATON® range, DWK Life Sciences offers a complete line of products for environmental sample collection, preparation and analysis according to the Environmental Protection Agency (EPA) methods. Products include BOD bottles, samplers, coliwasas and analytical apparatus.

WHEATON® BOD Bottles are ideal for incubating diluted samples of sewage, sewage effluents, polluted waters and industrial wastes to determine the amount of oxygen required during the stabilization of the decomposable organic matter by aerobic biochemical action.

Sampling devices, including samplers and coliwasas, are available for use with liquids, solids, sludges, soil and water. These products are designed for industrial and QC applications, environmental compliance, hazardous / toxic materials evaluation and site evaluation / remediation work.

Environmental

> BOD Bottles.....	99
> BOD Accessories.....	100
> Bomb Sampler.....	101
> Coliwasas.....	101
> Drum Openers.....	104
> Drum Thieves.....	101
> EPA Vials.....	103
> E-Z Sampler®.....	102
> Grab Sampler® I-III.....	102
> Imhoff Cone.....	104
> Oil Sample Bottle.....	104
> Scoop, Stainless Steel.....	104
> Weighing Dishes.....	103



BOD Bottles

- Ideal for incubating diluted samples of sewage, sewage effluents, polluted waters and industrial wastes to determine the amount of oxygen required during the stabilization of the decomposable organic matter by aerobic biochemical action
- We recommend the 300mL capacity bottles for the five-day BOD test as referenced in Standard Methods for the Examination of Water and Wastewater, 21st Edition, 5210B, 2005
- Specially designed bottle shoulder radius that sweeps all air from inside the bottle during filling
- The interchangeable stoppers have a tapered bottom that prevents air entrapment

- The bottles have a flared mouth to form a water seal around the stopper that prevents air from being drawn into the bottle during incubation
- Stopper joint is compatible with the probes of the leading meters for BOD and dissolved oxygen
- Large, permanently screened-on writing patch on all bottles
- Manufactured from USP Type I borosilicate glass



Cat. No.	Cap (mL)	Number Sequence	Barcoding	Dia. x H (mm)	Stopper	Qty / Case
227494-00G	60mL	Un-numbered	No	43 x 115	Glass Pennyhead	36
227494-00	60mL	Un-numbered	No	43 x 115	Glass Robotic	36
227494-01G	60mL	01-36	No	43 x 115	Glass Pennyhead	36
227494-01	60mL	01-36	No	43 x 115	Glass Robotic	36
227494-02G	60mL	37-72	No	43 x 115	Glass Pennyhead	36
227494-02	60mL	37-72	No	43 x 115	Glass Robotic	36
227494-03G	60mL	73-108	No	43 x 115	Glass Pennyhead	36
227494-03	60mL	73-108	No	43 x 115	Glass Robotic	36
227494-99G*	60mL	Specials	No	43 x 115	Glass Pennyhead	36
227494-99*	60mL	Specials	No	43 x 115	Glass Robotic	36
227498	300mL	Un-numbered	No	69 x 143	Without Stopper	24
227497-00G	300mL	Un-numbered	No	69 x 165	Glass Pennyhead	24
227497-00	300mL	Un-numbered	No	69 x 165	Glass Robotic	24
227497-01G	300mL	01-24	Yes	69 x 165	Glass Pennyhead	24
227497-01	300mL	01-24	Yes	69 x 165	Glass Robotic	24
227497-02G	300mL	25-48	Yes	69 x 165	Glass Pennyhead	24
227497-02	300mL	25-48	Yes	69 x 165	Glass Robotic	24
227497-03G	300mL	49-72	Yes	69 x 165	Glass Pennyhead	24
227497-03	300mL	49-72	Yes	69 x 165	Glass Robotic	24
227497-04G	300mL	73-96	Yes	69 x 165	Glass Pennyhead	24
227497-04	300mL	73-96	Yes	69 x 165	Glass Robotic	24
227497-05G	300mL	97-120	Yes	69 x 165	Glass Pennyhead	24
227497-05	300mL	97-120	Yes	69 x 165	Glass Robotic	24
227497-06G	300mL	121-144	Yes	69 x 165	Glass Pennyhead	24
227497-06	300mL	121-144	Yes	69 x 165	Glass Robotic	24
227497-07G	300mL	145-168	Yes	69 x 165	Glass Pennyhead	24
227497-07	300mL	145-168	Yes	69 x 165	Glass Robotic	24
227497-08G	300mL	169-192	Yes	69 x 165	Glass Pennyhead	24
227497-08	300mL	169-192	Yes	69 x 165	Glass Robotic	24
227497-09G	300mL	193-216	Yes	69 x 165	Glass Pennyhead	24
227497-09	300mL	193-216	Yes	69 x 165	Glass Robotic	24
227497-10G	300mL	217-240	Yes	69 x 165	Glass Pennyhead	24
227497-10	300mL	217-240	Yes	69 x 165	Glass Robotic	24
227497-11G	300mL	241-264	Yes	69 x 165	Glass Pennyhead	24
227497-11	300mL	241-264	Yes	69 x 165	Glass Robotic	24
227497-12G	300mL	265-228	Yes	69 x 165	Glass Pennyhead	24
227497-12	300mL	265-228	Yes	69 x 165	Glass Robotic	24
227497-13G	300mL	289-312	Yes	69 x 165	Glass Pennyhead	24
227497-13	300mL	289-312	Yes	69 x 165	Glass Robotic	24
227497-14G	300mL	313-336	Yes	69 x 165	Glass Pennyhead	24
227497-14	300mL	313-336	Yes	69 x 165	Glass Robotic	24
227497-15G	300mL	337-360	Yes	69 x 165	Glass Pennyhead	24
227497-15	300mL	337-360	Yes	69 x 165	Glass Robotic	24
227497-16G	300mL	361-384	Yes	69 x 165	Glass Pennyhead	24
227497-16	300mL	361-384	Yes	69 x 165	Glass Robotic	24
227497-17G	300mL	385-408	Yes	69 x 165	Glass Pennyhead	24
227497-17	300mL	385-408	Yes	69 x 165	Glass Robotic	24
227497-18G	300mL	409-432	Yes	69 x 165	Glass Pennyhead	24
227497-18	300mL	409-432	Yes	69 x 165	Glass Robotic	24

* For specials contact DWK Life Sciences Customer Service

Replacement Stoppers

- For 60mL and 300mL BOD Bottles



Cat. No.	Description	Qty / Case
227670	Robotic Stopper, Glass	12
227672	Pennyhead Stopper, Glass	12

BOD Bottle, Black, 300mL

- Ideal for light sensitive samples
- Coated with black PVC plastic to block all visible light up to 800nm to inhibit the production of oxygen by algae
- Recommended for use in marine photosynthesis projects when comparing oxygen in a light and a dark bottle
- Supplied with a glass robotic stopper and an opaque black cap
- Manufactured from USP Type I borosilicate glass



Cat. No.	Dia. x H (mm)	Qty / Case
227667	73 x 167	20

*For replacement stoppers use Cat. No. 227670

BOD Bottle, 2L

- Recommended for long-term BOD and ultimate BOD analysis
- Manufactured from WHEATON 33 low extractable borosilicate glass that conforms to USP Type I and also ASTM E 438 Type I Class A requirements and comes complete with a glass robotic stopper



Cat. No.	Dia. x H (mm)	Qty / Case
227580	128 x 272	1

*For replacement stoppers use Cat. No. 227670

BOD Bottle Aerator

- 40-60µm porosity glass frit
- For use with 300mL bottle
- EPA Method 245.1 Manual Cold Vapor Technique
- Used in determining inorganic forms of mercury and organic mercurials in drinking, surface and saline waters, as well as domestic and industrial waste
- Manufactured from WHEATON 200 low extractable borosilicate glass that conforms to USP Type I and also ASTM E 438 Type I, Class A requirements



Cat. No.	Description	Qty / Case
227700	BOD Aerator	1

BOD Bottle Cap

- Polyethylene cap prevents evaporation of the water seal during the five-day BOD incubation period
- Includes foam insert to exert pressure on the bottle stopper to hold it securely



Cat. No.	Description	Qty / Case
227723	BOD Bottle Cap	50

BOD Bottle Rack

- Conveniently and safely transports BOD bottles
- Racks are stackable
- Not autoclavable



Cat. No.	For Bottle Size	Holds	L x W x H (in)*	Max Bottle Dia.	Qty / Case
W227729	60mL	20 Bottles	13 x 10 x 7 in	49mm	1
W227731	300mL	12 Bottles	13 x 10 x 7 in	76mm	1

*33.03 x 25.4 x 17.78cm

BOD Stopper Leash

- Rubber leash prevents loss of stoppers
- Leash has 10mm diameter holes at each end to expand to fit securely around both the stoppers and the bottle necks



Cat. No.	Description	Qty / Case
776580	Stopper Leash	25

Bomb Sampler

- Ideal for sub-surface liquid sampling
- 500mL capacity
- These units are constructed of corrosion resistant Type 304 stainless steel
- A weighted plunger with a FKM "O" ring seals the reservoir chamber at the bottom
- Use a cable to lower sampler to desired depth
- Pull second cable to operate the sampling valve and release to reseal the chamber
- Cables not included
- Recommended for use with a cable that can support 50 pounds or more and is made from stainless or PTFE coated stainless steel



Cat. No.	Capacity (mL)	Dia x Length	Qty / Case
885200	500	2.75 x 10" (7 x 25.4cm)	1

Drum Thieves

- Drum thieves are ideal for quick and easy sample retrieval
- To use, simply insert one end of the drum thief into a drum and hold a finger over the opening on the other end to trap liquid in the tube
- Carefully remove the drum thief and empty the contents into a testing container
- Disposable
- Open ended
- These soda-lime glass units are 43" long and can be easily broken for quick disposal



Cat. No.	Approx. Capacity (mL)	Dia (mm)	Qty / Case
885300	25	7.5	100
885302	75	12	24
885303	150	18	24

Coliwasa, Reusable



- Uniquely designed top spin bar and bottom valve plate mechanism provides a positive seal for sample retention along with greater control for releasing the sample
- Manufactured from clear PVC
- Sampling can be achieved up to 20'
- Modular design adds flexibility by enabling the connection of several sections to form a longer sampling unit up to 20' (610cm)
- Provided with a 48" long cleaning brush
- Dimensions (ID x OD): 1 3/8" x 1 5/8" (3.5 x 4.12cm)

Cat. No.	Description	Approx. Volume (mL)	Qty / Case
Coliwasa Unit			
885250	4' (122cm) Coliwasa Unit	760	1
885252	6' (183cm) Coliwasa Unit	1100	1
Extension and Connector			
885253	4' (122cm) Extension and Connector	760	1
Replacement Parts			
885258	Bottom Plate and SS Nut	—	1

Coliwasa Sampler, Glass



- Used to collect composite liquid samples from top to bottom in drums, tanks and reservoirs
- Easy to use
- Disposable or reusable units available
- Liquid-tight PTFE seal eliminates sample leakage
- PTFE seal design permits sampling to within 1/2" of drum bottom
- After a sample has been collected, lower and press lightly on the inner tube, which positively seats the PTFE seal, locking the sample column into place
- Unit has a tapered bottom with an approximate diameter opening of 1/2", (1.3cm) and a sample capacity of 200mL
- Prescored samplers make disposal easier
- Dimensions: Diameter 7/8" x Length 42", (2.25cm x 106.5cm)

Cat. No.	Description	Material	Qty / Case
Disposable Unit			
885220	Pre-scored	Soda-Lime Glass	12
Reusable Unit			
885230	Unscored	Borosilicate Glass	12
885231	Pre-scored	Borosilicate Glass	12
Replacement Seals			
885232	Replacement Seals	PTFE	10

Coliwasa, Trumpet



- Use for sampling sludge or semi-solid material
- Disposable soda-lime glass
- Rigidity of the glass makes it suitable for boring through semi-solid sludge-type materials
- Tight PTFE seal keeps in liquid and sludge material
- Outer tube is 40" (101.6cm) long

Cat. No.	Description	Qty / Case
885235	200mL Capacity	1

E-Z Sampler®

- Ideal for sampling unknowns from open-top drums and tanks
- Manufactured from chemically resistant polypropylene
- The E-Z Sampler® has a 39" (100cm) head/shaft assembly and is supplied with a 125mL borosilicate glass bottle with a PTFE lined cap
- Filling ports are located above the bottle to ensure that it is completely filled to reduce the possibility of air entrapment
- Bottle has a 33-430 screw thread finish



Cat. No.	Description	Qty / Case
885020	Complete Unit with Bottle	1
885025	125mL Bottle, with Cap	12
240480	Replacement Cap	100

Sub Surface Grab Sampler® I

- Ideal for sampling from spillways, docks and other sub surfaces
- No need to physically enter the sample area
- Eliminates surface contamination
- Helps meet EPA requirements for water and wastewater sampling
- Lightweight construction
- Constructed of 72" x 3/4" (183 x 2cm) square aluminum tubing with a golden anodine finish
- Provided with a 1000mL narrow-mouth borosilicate glass sample bottle with a PTFE-lined cap and clamps for large and small bottles



Cat. No.	Description	Qty / Case
990250	Sub Surface Grab Sampler® I	1
990477	Replacement Sample Bottle, 1000mL, 38-430	1
240481	Black Phenolic Replacement Cap	100

Sub Surface Grab Sampler® II

- Excellent for accessing fluid flow in deep manholes and hard to reach sub-surface sampling areas
- Helps meet EPA requirements for water and waste water sampling
- Available in lengths up to 18' (5.5m)
- Each sampler consists of an inert polypropylene head with stainless steel fittings and an aluminum pole assembly with a golden alodine finish
- Provided with a 1000mL narrow-mouth borosilicate glass sample bottle with a PTFE-lined cap
- To use it, screw a sample bottle into the head and lower to the desired depth
- Pull the cable at the top of the handle which will lift a spring-loaded plunger from the bottle opening, allowing liquid to enter through four 5/8" diameter holes
- Release the cable when the bottle is full to reset the plunger



Cat. No.	Description	Qty / Case
990350	6' (183cm) Sub Surface Grab Sampler® II	1
990400	12' (366cm) Sub Surface Grab Sampler® II	1
990450	18' (549cm) Sub Surface Grab Sampler® II	1
990477	Replacement Sample Bottle	1
240481	Black Phenolic Replacement Cap	100

Sample Bottle, Narrow Mouth

- For use with Sub Surface Grab Sampler® I & II
- 1000mL narrow mouth borosilicate glass bottle
- 38-430 screw cap with PTFE liner
- Autoclavable
- The bottle has a hand grip for easy handling



Cat. No.	Description	Qty / Case
990477	1000mL Bottle with Cap	1

Sample Bottle, Wide Mouth

- For use with Sub Surface Grab Sampler® III
- 1000mL wide mouth borosilicate glass bottle
- 70-400 screw cap with PTFE liner
- Autoclavable
- These wide mouth sample bottles can be repeatedly autoclaved and come with PTFE-lined caps



Cat. No.	Description	Qty / Case
990476	1000mL Bottle with Cap	1

WHEATON® Chemistry Glassware

The WHEATON portfolio offers a vast selection of analytical apparatus used in the examination of environmental samples including Arsine Generators, Cyanide Distillation Kits, Kuderna-Danish Concentrators and Soxhlet Extraction Apparatus. WHEATON glassware is designed with convenience in mind with features such as Clear-Seal™ joints and the WHEATON Connection® screw thread finish ends.

- > Manufactured from WHEATON 33 low extractable borosilicate glass that conforms to USP Type I and ASTM E 438 Type I, Class A requirements
- > Meet ASTM / USP and EPA specifications
- > Clear-Seal™ Joints seal without grease, reducing the possibility of seizing
- > The WHEATON Connection® safely joins two exterior-threaded glass components without hooks, springs or clamps



See more information on Chemistry Glassware on page 70.

Weighing Dishes

- Made from aluminum
- Ideal for milligram weighing
- Use with liquids or solids
- Smooth surface ensures complete transfer
- Use of balance-type forceps enables easy grasping



Cat. No.	Dia. x H (mm)	Qty / Case
370790	11 x 6	1000
370792	20 x 8	1000

EPA Vial, 40mL

- Ideal for use in water sampling according to EPA 40 CFR 136, "Guidelines for Establishing Test Procedures for the Analysis of Pollutants"
- Clear vials manufactured from WHEATON 33 low extractable borosilicate glass that conforms to USP Type I and ASTM E438 Type I, Class A requirements
- Amber vials manufactured from WHEATON 320 amber glass that conforms to USP Type I requirements for light transmission to protect light-sensitive products
- Caps attached to vials
- Vials packaged in convenient trays for ease of use

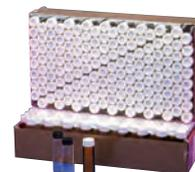

Cat. No.	Size (mL)	Size (dr)	*Dia. x H (mm)	Cap Size	Qty / Case
Clear Vial with Open Top Black Phenolic PTFE Faced Silicone Lined Cap					
225310	40	10	28 x 98	24-400	72
Amber Vial with Open Top White Polypropylene PTFE Faced Silicone Lined Cap					
225315	40	10	28 x 98	24-400	72

*Measurement taken with cap attached.

Replacement 24-400 Screw Caps & Septa

Cat. No.	Description	Qty / Case
W240518	Black Phenolic Open Top Screw Cap w/o Septa	200
W224600	White Glass-Filled Open Top Polypropylene Cap with Bonded 5 mils PTFE / 120 mils Silicone Septa	200

Vials for Environmental Analysis



Cat. No.	Size (mL)	Size (dr)	Dia. x H (mm)*	Cap Size	Qty / Case
Clear Vial with Open Top White Polypropylene PTFE Faced Silicone Lined Cap (Septa of 5 mils of PTFE facing 120 mils of silicone is bonded to cap.)					
W224609	20	5	28 x 60	24-400	72
W224610	25	6.25	28 x 73	24-400	72
Amber Vial with Open Top White Polypropylene PTFE Faced Silicone Lined Cap (Septa of 5 mils of PTFE facing 120 mils of silicone is bonded to cap.)					
W224612	20	5	28 x 60	24-400	72
W224614	40	10	28 x 98	24-400	72

*Cap on

Imhoff Cone, Plastic

- Designed for volumetric determination of settleable solids
- Cone is externally graduated from the plug up to 1000mL
- Imhoff Cone is manufactured from an acrylic copolymer and includes a rubber plug and polypropylene cap
- Remove the leak-resistant screw cap and plug to clean
- Reference: Standard Methods for the Examination of Water and Wastewater, 21st Edition (2005), Method 2540 F
- 3 and 4-place Imhoff Cone Racks are sold separately and are constructed of epoxy-coated, heavy-gauge steel to provide long life



Cat. No.	Description	Size (mL)	Top Dia x Length (mm)	Qty / Case
W990800	Imhoff Cone	1000	108 x 451	4

Imhoff Cone Racks

990760	3-Place Rack	—	—	1
990760-4	4-Place Rack	—	—	1

Drum Opener

- Can be used with hazardous materials
- Cast from lightweight, durable aluminum alloy and features a quarter-turn opening action
- Opens all 3/4" and 3" closures



Cat. No.	Qty / Case
885295	1

Scoop, Stainless Steel

- Manufactured from 18/8 stainless steel
- Ideal for sampling powders, slurries, soils, etc.
- Dimensions: Overall length is 9-1/2" (24cm); the bowl's dimensions are 5 1/2" x 3" x 1 1/8" (14 x 7.6 x 2.9cm) 4oz



Cat. No.	Qty / Case
885540	4

Oil Sample Bottle, Clear

- Clear, Type III soda-lime glass
- Bottles come with cork inserted



Cat. No.	Capacity (oz)	Capacity (mL)*	Dia. x H (mm)	Qty / Case
W216994	4	125	37 x 163	144

*Approximate capacity



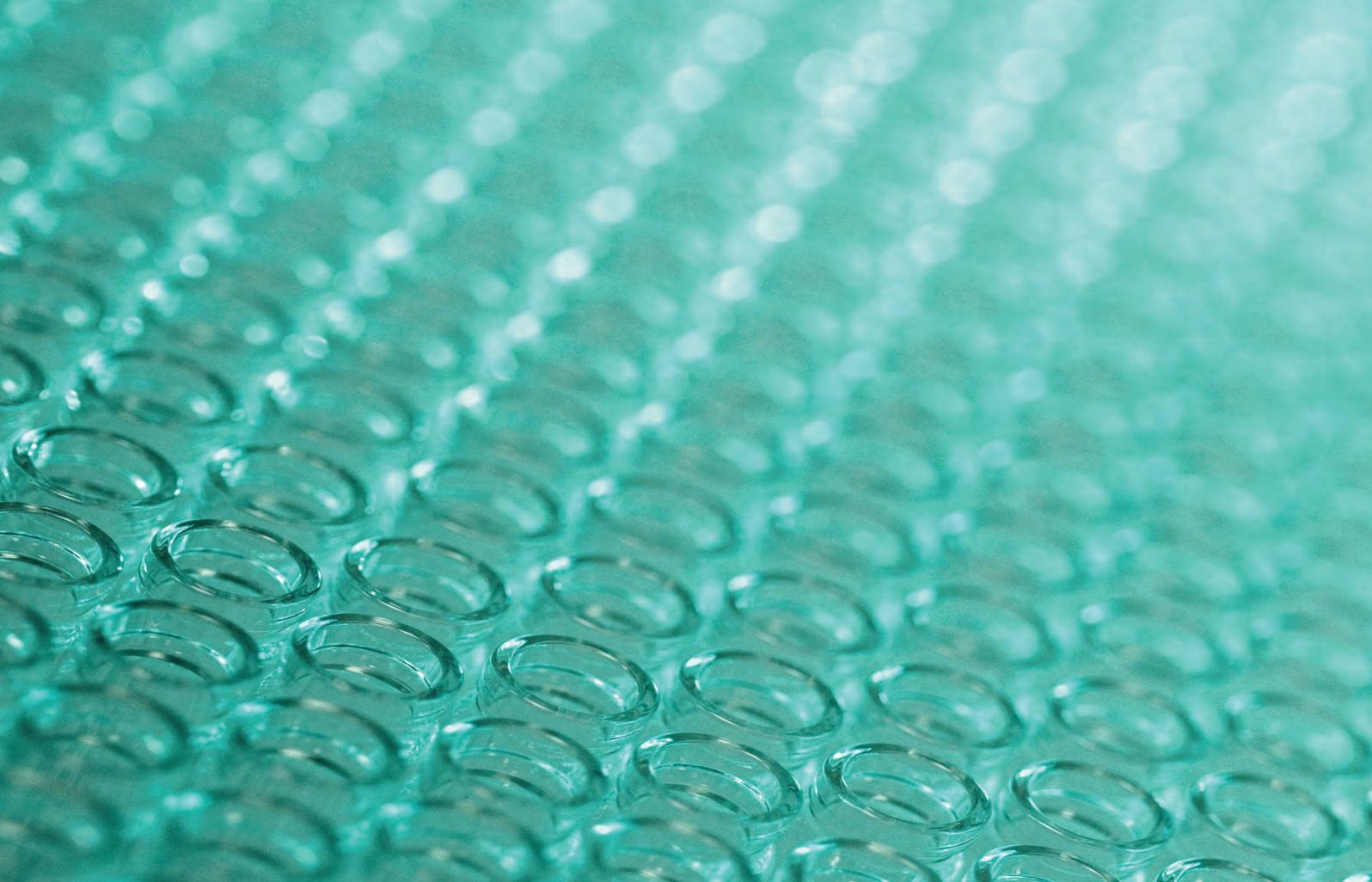

For the Smaller Samples in Life

Vials

DWK Life Sciences offers the most comprehensive line of vials and accessories for the laboratory research market. Sample vials, fabricated from high-quality glass tubing, offer uniform sidewall and bottom thickness. Liquid scintillation vials are the original scintillation vials invented by WHEATON® over 60 years ago. Manufactured from low potassium borosilicate glass, PET and HPDE, the DWK Life Sciences line of vials is the largest and most diverse in the industry. High recovery vials feature a conical interior that allows for maximum retrieval of a sample with a syringe. Certain vial styles can be used with automated compound storage systems and easily bar coded using a 2D or linear bar code format. WHEATON® CryoELITE® Cryogenic Vials offer unrivaled cappings that exceed DOT and IATA regulations.

When you are looking for a high-quality and dependable vial, DWK Life Sciences can provide the best product for your application. We can also accommodate the custom design and manufacturing of vials as well as bar coding, critical cleaning, and surface treatment services.

Vials

> Bar Code Readers	109
> Cap Liner Guide	111
> CryoELITE®	107-108
> Cryogenic	107-110
> Diagnostic	123
> Dilution Vial	114
> EPA	114
> E-Z Ex-Traction®	120
> E-Z MicroTubes	108
> Freezer Boxes	110
> Liquid Scintillation	112-113
> Racks	110, 124
> Sample	116-119
> Sample Vial Sizer Guide	115
> Serum	122
> Tissue Vial	107
> Vacule®	122
> Vial File®	124
> Vial for Environmental Analysis	114
> V-Vials®	121





The WHEATON CryoELITE® Tissue Vial is for those who value sample integrity, designed specifically for tissue collection, transport and storage to provide the utmost protection. Different from cells and biofluids, tissue specimens have particular requirements for cryogenic storage. Offering researchers a uniform vial able to maintain sample integrity while maximizing storage capacity and organization, the CryoELITE Tissue Vials feature a wide-mouth opening, 5mL capacity and high integrity closure. The CryoELITE Tissue Vial offers researchers who work with tissue samples ease of use, convenience and security.

The CryoELITE Tissue Vials are manufactured from low binding, cryogenic-grade virgin polypropylene that meets the USP Class VI classification. Lot tested and certified to be free of pyrogens, RNase / DNase and endotoxins, the vials have a sample capacity of 5mL and a storage temperature range of -156°C to 121°C. The externally threaded cap provides a seal that exceeds DOT and IATA classifications for diagnostic specimens and their transport and is capable of maintaining a secure closure during freeze/thaw procedures. The vials have a flat bottom and a stippled external surface to promote easier handling.

The CryoELITE Tissue Vial is for those who value sample integrity, designed specifically for tissue collection, transport and storage to provide the ultimate protection. When your decision depends on sample integrity...Trust that specimen to a WHEATON CryoELITE Tissue Vial.



CryoELITE® Tissue Vial

- Lot certified RNase/DNase and Endotoxin Free providing assurance of product integrity
- Unrivaled cap seal exceeds DOT and IATA regulations ensuring ultimate protection of samples during transportation and demanding freeze-thaw handling
- Wide mouth for insertion and removal of tissue with forceps
- 5mL volume for use with tissue sections
- Directional indicators to allow orientation of tissue within vial
- Bagged in packs of 25 vials

Cat. No.	Size (mL)	Color	Sterile	Dimensions Dia. x H (mm)	Depth (mm)	Qty/ Case
W985100	5	White	Yes	22 x 24	18	250

CryoELITE® Cryogenic Vials

- Lot certified RNase / DNase and endotoxin free and non-pyrogenic providing assurance for sample integrity
- Unrivaled cap seal exceeds DOT and IATA regulations ensuring ultimate protection of samples during transportation and demanding freeze-thaw handling
- Made from low binding, cryogenic grade virgin polypropylene
- Screw cap can be easily removed with one hand

Freestanding

- Loctagon™ Vial Skirt provides stability in freestanding position and locks into CryoELITE® Benchmate Rack in order to provide easy open and close with one hand
- Colored caps allow for color coding projects along with WHEATON colored freezer and storage boxes
- Optional 2D Data Matrix Bar Code Insert provides unique identifier for traceability
- Bottom format allows unrestricted view of 2D bar code for convenient automated scanning

Round Bottom

- Exacting round bottom allows for up to 17,000 MAX RCF (xG)

Cat. No.	Size (mL)	Color	Writing Patch	Sterile	Dimensions Dia. x H (mm)	Qty / Case
CryoELITE® Vials, Freestanding, Internal Thread						
W985915	1.2	Natural	Yes	Yes	12 x 40	500
W985902	2	Natural	Yes	No	12 x 50	1000
W985903	2	Natural	No	No	12 x 50	1000
W985922	2	Natural	Yes	Yes	12 x 50	500
W985916	2	White	Yes	Yes	12 x 50	500
W985917	2	Red	Yes	Yes	12 x 50	500
W985918	2	Pink	Yes	Yes	12 x 50	500
W985919	2	Yellow	Yes	Yes	12 x 50	500
W985920	2	Green	Yes	Yes	12 x 50	500
W985921	2	Blue	Yes	Yes	12 x 50	500
W985923	3	Natural	Yes	Yes	12 x 63	500
W985924	4	Natural	Yes	Yes	12 x 77	500
W985925	5	Natural	Yes	Yes	12 x 91	500
CryoELITE® Vials, Freestanding, External Thread						
W985874	0.5	White	Yes	Yes	12 x 49	500
W985862	1.2	Natural	Yes	Yes	12 x 37	500
W985883	1.2	White	Yes	Yes	12 x 37	500
W985884	1.2	Red	Yes	Yes	12 x 37	500
W985885	1.2	Pink	Yes	Yes	12 x 37	500
W985886	1.2	Yellow	Yes	Yes	12 x 37	500
W985887	1.2	Green	Yes	Yes	12 x 37	500
W985888	1.2	Blue	Yes	Yes	12 x 37	500
W985852	2	Natural	Yes	No	12 x 49	1000
W985853	2	Natural	No	No	12 x 49	1000
W985872	2	Natural	Yes	Yes	12 x 49	500
W985863	2	White	Yes	Yes	12 x 49	500
W985864	2	Red	Yes	Yes	12 x 49	500
W985865	2	Pink	Yes	Yes	12 x 49	500
W985866	2	Yellow	Yes	Yes	12 x 49	500
W985867	2	Green	Yes	Yes	12 x 49	500
W985868	2	Blue	Yes	Yes	12 x 49	500
W985869	3	Natural	Yes	Yes	12 x 63	500
W985870	4	Natural	Yes	Yes	12 x 78	500
W985871	5	Natural	Yes	Yes	12 x 93	500
CryoELITE® Vials, Round Bottom, Internal Thread						
W985910	1.2	Natural	Yes	Yes	12 x 39	500
W985911	2	Natural	Yes	Yes	12 x 49	500
W985900	2	Natural	Yes	No	12 x 49	1000
W985901	2	Natural	No	No	12 x 49	1000
W985912	3	Natural	Yes	Yes	12 x 63	500
W985913	4	Natural	Yes	Yes	12 x 76	500
W985914	5	Natural	Yes	Yes	12 x 90	500
CryoELITE® Vials, Round Bottom, External Thread						
W985860	1.2	Natural	Yes	Yes	12 x 35	500
W985861	2	Natural	Yes	Yes	12 x 49	500
W985850	2	Natural	Yes	No	12 x 49	1000
W985851	2	Natural	No	No	12 x 49	1000

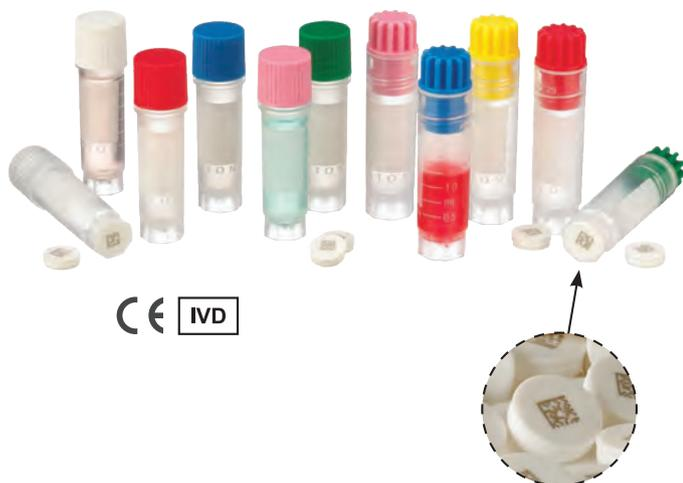

E-Z Microtube

- Polypropylene
- Uniquely numbered to ensure zero duplicated
- Fully traceable for perfect data management
- For storage down to -196°C
- Long lasting performance stability
- Supplied in a standard format 96-well rack with locking lid
- 1.0 and 1.4mL tubes supplied in standard twist-lock 96-well rack with locking lid

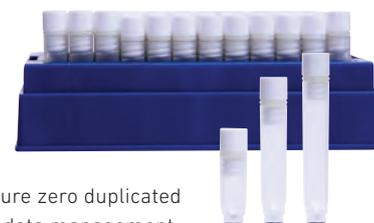

Cat. No.	Volume (mL)	Description	Qty / Case
W280110	0.5	E-Z Microtube, PP, 2D Barcode	10
W280121	1.0	E-Z Microtube, PP, 2D Barcode	10
W280135	1.4	E-Z Microtube, PP, 2D Barcode	10

CryoELITE® Cryogenic Vials Shelf Packs

- Packed in convenient smaller quantities
- 2 packs of 50 vials

Cat. No.	Size (mL)	Color	Writing Patch	Sterile	Dimensions Dia. x H (mm)	Qty / Case
CryoELITE® Vials, Freestanding, External Thread						
W985863-100 2	White	Yes	Yes	□	12 x 49	100
W985864-100 2	Red	Yes	Yes	■	12 x 49	100
W985865-100 2	Pink	Yes	Yes	■	12 x 49	100
W985866-100 2	Yellow	Yes	Yes	■	12 x 49	100
W985867-100 2	Green	Yes	Yes	■	12 x 49	100
W985868-100 2	Blue	Yes	Yes	■	12 x 49	100
W985872-100 2	Natural	Yes	Yes		12 x 49	100

CryoELITE® Cryogenic Vials, Pre-inserted Barcodes

- CryoELITE vials w/ 2D Data Matrix Barcode insert already applied

Cat. No.	Size (mL)	Color	Writing Patch	Sterile	Dimensions Dia. x H (mm)	Qty / Case
CryoELITE® Vials, Freestanding, External Thread						
W985863-BC 2	White	Yes	Yes	□	12 x 49	500
W985864-BC 2	Red	Yes	Yes	■	12 x 49	500
W985865-BC 2	Pink	Yes	Yes	■	12 x 49	500
W985866-BC 2	Yellow	Yes	Yes	■	12 x 49	500
W985867-BC 2	Green	Yes	Yes	■	12 x 49	500
W985868-BC 2	Blue	Yes	Yes	■	12 x 49	500

2D Data Matrix Bar Code Bottom Insert

- When purchasing WHEATON CryoELITE® freestanding vials, you can purchase an optional 2D Data Matrix Bar Code Insert that allows for immediate bar coding of your samples. The insert can also be applied to the vial at a future date, which eliminates jeopardizing the integrity of your sample by transferring it to another vial
- 2D Data Matrix Bar Code Insert press fits and locks into place in bottom of vial

Cat. No.	Description	Sterile	Shelf Pack	Qty / Case
W985881	2D Data Matrix Bar Code Bottom Insert	No	100	500

CryoELITE® Technical Information

Material:	Made from low binding, cryogenic grade virgin polypropylene
Temperature Range:	-156°C to +121°C, tested to -196°C
Sterility:	Lot Certified Sterile, Radiation Sterilization
DNase & RNase Free:	Lot Certified, Ethidium Bromide (EtBr) Agarose Gel Electrophoresis Analysis
Non-Pyrogenic, Endotoxin Free:	Lot Certified < 0.500 EU/mL (Kinetic Turbidimetric LAL Method, FDA guideline)
Seal psi:	Exceeds 15 psi / 1 atmosphere / 95kPa pressure tested
IATA (International Air Transportation Association):	Can be used as a primary receptacle for the Transport of Diagnostic Specimens as outlined by the IATA Dangerous Goods Regulations, Part 6.3.5
DOT (U.S. Department of Transportation):	Exceeds U.S. DOT 49 CFR Parts 171-180 requirements for Diagnostic Specimen Packing and Transportation Requirements
Liquid Nitrogen:	Liquid phase tested / Vapor phase accepted
Autoclavable:	Recommended at +121°C, 15 psi (1 bar) for 20 minutes
Cap Pigmentation:	Cap colors were chosen to ensure no reactivity with common biological samples
2D Data Matrix Capacity:	Numeric 16 / Alphanumeric 10
2D Data Matrix Symbol Size:	Row x Column: 14 x 14
CE :	Product is CE compliant to The European <i>In Vitro</i> Diagnostic Medical Devices Directive 98/79/EC



SingleScan™ Bar Code Reader

- Plug and play design enables easy set up with no software installation required
- USB interface allows easy connection to computer
- Reads 1D linear bar codes and 2D Data Matrix bar codes on any vial or ampule
- Inputs decoded bar code ID into any software application where cursor is placed



Cat. No.	Description	Qty
W986000	SingleScan™ Bar Code Reader	1

PluraScan™ Bar Code Reader

- 2D Data Matrix Bar Code Reader
- Works with WHEATON KeepIt® Boxes and WHEATON CryoELITE® Cryogenic Vials and Cryule® Ampules as well as WHEATON E-Z Microtubes
- Flexible software integration
- Integrated frost reduction system allows multiple racks to be read
- Capable of reading bar codes from wide range of manufacturers and label printers

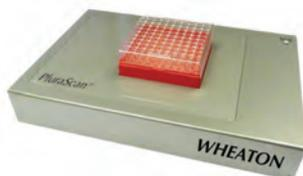

Cat. No.	Description	Qty
W986010- []*	PluraScan™ Bar Code Reader	1

2D Data Matrix Bar Code Bottom Insert

- When purchasing WHEATON CryoELITE® freestanding vials, you can purchase an optional 2D Data Matrix Bar Code Insert that allows for immediate bar coding of your samples. The insert can also be applied to the vial at a future date, which eliminates jeopardizing the integrity of your sample by transferring it to another vial
- 2D Data Matrix Bar Code Insert press fits and locks into place in bottom of vial

Cat. No.	Description	Sterile	Qty / Case
W985881	2D Data Matrix Bar Code Bottom Insert	No	500

WHEATON Scanners Technical Information

Code Formats	SingleScan™	PluraScan™
1D Linear	✓	—
2D Data Matrix	✓	✓
ISO 16022	✓	✓
Square Rectangular Format	✓	✓
ECC 200	✓	✓
0-20 Grid Sizes	✓	✓
White on Black Black on White	✓	✓
Numeric	✓	✓
Alphanumeric	✓	✓
Sensor Type	1.3 million pixel CMOS sensor	CCD Image Sensor
Light Source	Class 2M visible laser diode at 630nm	CCFL (Cold Cathode Fluorescent Light Source)
Dimensions (W x D x H)	61mm x 167mm x 41.2mm	75cm x 50cm x 30cm
Power	USB Hub (5V)	AC 100 to 240V, +10%/-10%, Less than 8W
User Interface	Keyboard Wedge	WHEATON GUI, including Windows® operating system TCP / IP, ODBC
Cable Interface	USB	USB2.0 USB 1.1 (B Type)
Operating System	Factory configured for Windows® operating systems compatibility. Also compatible with non-windows operating systems	Windows®7, 2000, XP
Ambient Operating Temperature	5 to 50°C	
Storage Temperature	-20 to 65°C	
Operating Humidity	(Non-condensing) 5 to 95°C	

	Plug Style
[A]	North American Cord, 120V
[B]	Japan Cord, 100V
[C]	Europe Cord, 230V
[D]	UK Cord, 230V
[F]	Australia / China, 240V
[G]	Italy / Chile, 230V
[J]	India Cord, 230V

KeepIT® Freezer Boxes



KeepIT®-25



KeepIT®-81 & 100

- KeepIT® Freezer Boxes provide an ideal method for batching and storing samples
- Six different colors match the colors of CryoELITE® Cryogenic Vials, creating alternatives for batching and identifying groups of samples
- KeepIT®-25 accommodates up to 25 internal or external threaded cryogenic Vial Sizes: 1.2 - 2mL
- KeepIT®-100 accommodates up to 100 internal threaded cryogenic vials and the KeepIT®-81 accommodates 81 external threaded cryogenic vials (sizes: 1.2 - 2mL)
- Openings in bottom facilitate scanning CryoELITE® 2D Data Matrix Bar Code Inserts
- Made from Eastman Tritan™ BPA free, shatter resistant resin
- Standard footprint compatible with liquid nitrogen storage shelves and freezer drawers

Cat. No.	Color	Dimensions (L x W x H) (mm)	Qty / Case
KeepIT®-25 For External Thread Vials			
W651702-W	White	75 x 75 x 52	10
W651702-R	Red	75 x 75 x 52	10
W651702-P	Pink	75 x 75 x 52	10
W651702-Y	Yellow	75 x 75 x 52	10
W651702-G	Green	75 x 75 x 52	10
W651702-B	Blue	75 x 75 x 52	10
Low Profile KeepIT®-81 For External Thread Vials			
W651703-W	White	130 x 130 x 52	10
W651703-R	Red	130 x 130 x 52	10
W651703-P	Pink	130 x 130 x 52	10
W651703-Y	Yellow	130 x 130 x 52	10
W651703-G	Green	130 x 130 x 52	10
W651703-B	Blue	130 x 130 x 52	10
Low Profile KeepIT®-100 For Internal Thread Vials			
W651704-W	White	130 x 130 x 52	10
W651704-R	Red	130 x 130 x 52	10
W651704-P	Pink	130 x 130 x 52	10
W651704-Y	Yellow	130 x 130 x 52	10
W651704-G	Green	130 x 130 x 52	10
W651704-B	Blue	130 x 130 x 52	10

CryoELITE® Benchmate Rack



- For use with both freestanding and round bottom vials
- One hand cap removal of freestanding vials
- Holds 50 cryogenic vials
- Manufactured from polypropylene
- Easily cleaned in an automatic washer or autoclavable at 121°C for 20 minutes
- Non-skid feet offer additional stability for bench work
- Stackable
- Well ID: 12.5mm
- Dimensions (L x W x H): (190 x 100 x 22mm)

Cat. No.	Description	No. of Wells	Qty / Case
W985810	50-Position Rack	5 deep x 10 wide	5

CryoFile® and CryoFile® XL Storage Boxes



- Use with cryogenic vials
- Partitions numbered from 1 – 81 for easy content identification
- Numbering system printed on lid and bottom of box
- Six colors provide easy sample identification
- Water repellent allows for longer durability
- For use with vapor phase of liquid nitrogen
- Directional holes in bottom allow for drainage and orientation of bottom to top of box
- Dimensions (L x W x H):
CryoFile® (130 x 130 x 53mm) / CryoFile® XL (130 x 130 x 97mm)
CryoFile® Tissue Box (130 x 130 x 26mm)

Cat. No.	Fits	Color	Qty / Case
CryoFile® Storage Box			
W651600	1.2 & 2mL Vials	Green	15
W651601	1.2 & 2mL Vials	Yellow	15
W651602	1.2 & 2mL Vials	Pink	15
W651603	1.2 & 2mL Vials	White	15
W651604	1.2 & 2mL Vials	Blue	15
W651605	1.2 & 2mL Vials	Red	15
CryoFile® XL Storage Box			
W651600-XL	3, 4 & 5mL Vials	Green	15
W651601-XL	3, 4 & 5mL Vials	Yellow	15
W651602-XL	3, 4 & 5mL Vials	Pink	15
W651603-XL	3, 4 & 5mL Vials	White	15
W651604-XL	3, 4 & 5mL Vials	Blue	15
W651605-XL	3, 4 & 5mL Vials	Red	15
CryoFile® Tissue Storage Box (holds 25 Tissue Vials)			
W651610-G	5mL Tissue Vials	Green	15
W651610-Y	5mL Tissue Vials	Yellow	15
W651610-P	5mL Tissue Vials	Pink	15
W651610-W	5mL Tissue Vials	White	15
W651610-B	5mL Tissue Vials	Blue	15
W651610-R	5mL Tissue Vials	Red	15

FTA® Nucleic Acid Collection Storage box



- Storage boxes provide an ideal method for batching and storing FTA Nucleic Acid Collection pouches
- For use with small or large FTA cards
- Accommodates two rows of 3" FTA card pouches or one row of 6" FTA Card Pouches
- Removable divider for use with smaller pouches
- Water repellent box material allows for longer durability
- For use at RT, 4°C, -20°C or colder

Cat. No.	Dimensions (L x W x H) (in)	Qty / Case
W651611	18 x 6 x 4	2
W651612	18 x 7 x 4	2



Select from Glass, HDPE and PET Vials

- Packaged in 5 utility trays with each partition tray holding 100 vials
- Utility trays serve as a way to store your samples
- For additional organization of your vials, use the WHEATON Vial Rack 868806 or M-T Vial File® W228792
- Cases with 1000 vials are packed in a single plastic bag with caps in a separate bag

Glass

- Made from WHEATON 180 low potassium borosilicate glass that conforms to USP Type I and ASTM E 438 Type I, Class A requirements
- Background counts are consistent and low, ultraviolet transmission is high

Cap Liner Guide

Liner Material	Description	Applications
Foamed Polyethylene (PE Foam)	A one piece, three ply coextruded liner consisting of both foamed and solid LDPE. The foam core is sandwiched with solid clear PE.	General Purpose: Broad applications base. Good chemical resistance to acids, alkalis, solvents, alcohols, oils, household cosmetics and aqueous products. Poor for hydrocarbon solvents. Liner provides tight seal.
Pulp / Metal Foil	Aluminum foil bonded to pulp board.	Good barrier properties and resistance to hydrocarbons, oils, ketones and alcohols. Not good for acids or alkalis.
Polyethylene Cone (PE Cone)	Manufactured from polyethylene (LDPE). The unique cone design provides a wedge type seal that not only seals across the top but also across the inside diameter.	Unique problem solving type of liner. This liner is stress crack resistant and offers superior torque retention and excellent sealing characteristics. It is recommended that this liner be tested prior to use for leak seal.

Note: Closures and liners are designed for a variety of applications. Product performance can vary depending on conditions. It is recommended that proper tests be performed to determine the best liner for the application.

HDPE

- Made from high density polyethylene with lightweight walls for increased counting efficiency
- Manufactured to precise tolerances to avoid jamming

PET

- Vials offer low permeability to solvents and minimal background counts
- Clarity of glass with the safety of plastic
- Vials can be safely incinerated; no harmful gas is generated



Liquid Scintillation Vials

Cat. No.	Size (mL)	Vial Material	Cap Material	Liner Material	Cap Size	Dia. x H (mm)*	Qty / Case
Caps Attached to Vials							
986540	20	Glass	Polypropylene	Foamed Polyethylene	22-400	28 x 61	500
986541	20	Glass	Polypropylene	Metal Foil / Pulp	22-400	28 x 61	500
986542	20	Glass	Urea	Metal Foil / Cork	22-400	28 x 61	500
986546	20	Glass	Urea	Polyethylene Cone	22-400	28 x 61	500
986548	20	Glass	Urea	Polyethylene Disc	22-400	28 x 61	500
986560	20	Glass	Polypropylene	Foamed Polyethylene	24-400	28 x 61	500
986561	20	Glass	Polypropylene	Metal Foil / Pulp	24-400	28 x 61	500
986562	20	Glass	Urea	Metal Foil / Cork	24-400	28 x 61	500
986568	20	Glass	Urea	Polyethylene Disc	24-400	28 x 61	500
986700	20	HDPE	Polypropylene	Foamed Polyethylene	22-400	27 x 61	500
986701	20	HDPE	Polypropylene	Metal Foil / Pulp	22-400	27 x 61	500
986702	20	HDPE	Urea	Metal Foil / Cork	22-400	27 x 61	500
986704	20	HDPE	Polyethylene	Linerless	22-400	27 x 61	500
986706	20	HDPE	Urea	Polyethylene Cone	22-400	27 x 61	500
986730	20	PET	Polypropylene	Foamed Polyethylene	22-400	27 x 61	500
986731	20	PET	Polypropylene	Metal Foil / Pulp	22-400	27 x 61	500
986732	20	PET	Urea	Metal Foil / Cork	22-400	27 x 61	500
986734	20	PET	Polyethylene	Linerless	22-400	27 x 61	500
986736	20	PET	Urea	Polyethylene Cone	22-400	27 x 61	500
Caps Packaged Separately							
986580	20	Glass	Polypropylene	Foamed Polyethylene	22-400	28 x 61	500
986581	20	Glass	Polypropylene	Metal Foil / Pulp	22-400	28 x 61	500
986582	20	Glass	Urea	Metal Foil / Cork	22-400	28 x 61	500
986586	20	Glass	Urea	Polyethylene Cone	22-400	28 x 61	500
986590	20	Glass	Polypropylene	Foamed Polyethylene	24-400	28 x 61	500
986591	20	Glass	Polypropylene	Metal Foil / Pulp	24-400	28 x 61	500
986710	20	HDPE	Polypropylene	Foamed Polyethylene	22-400	27 x 61	500
986720	20	HDPE	Polypropylene	Foamed Polyethylene	22-400	27 x 61	1000
986711	20	HDPE	Polypropylene	Metal Foil / Pulp	22-400	27 x 61	500
986721	20	HDPE	Polypropylene	Metal Foil / Pulp	22-400	27 x 61	1000
986714	20	HDPE	Polyethylene	Linerless	22-400	27 x 61	500
986724	20	HDPE	Polyethylene	Linerless	22-400	27 x 61	1000
986722	20	HDPE	Urea	Metal Foil / Cork	22-400	27 x 61	1000
986716	20	HDPE	Urea	Polyethylene Cone	22-400	27 x 61	500
986726	20	HDPE	Urea	Polyethylene Cone	22-400	27 x 61	1000
986750	20	PET	Polypropylene	Foamed Polyethylene	22-400	27 x 61	500
986740	20	PET	Polypropylene	Foamed Polyethylene	22-400	27 x 61	1000
986751	20	PET	Polypropylene	Metal Foil / Pulp	22-400	27 x 61	500
986741	20	PET	Polypropylene	Metal Foil / Pulp	22-400	27 x 61	1000
986754	20	PET	Polyethylene	Linerless	22-400	27 x 61	500
986744	20	PET	Polyethylene	Linerless	22-400	27 x 61	1000
986752	20	PET	Urea	Metal Foil / Cork	22-400	27 x 61	500
986742	20	PET	Urea	Metal Foil / Cork	22-400	27 x 61	1000
986756	20	PET	Urea	Polyethylene Cone	22-400	27 x 61	500
986746	20	PET	Urea	Polyethylene Cone	22-400	27 x 61	1000

*Measurement taken with cap attached.

Glass Liquid Scintillation Vial

(Without Screw Caps)

- Made from WHEATON 180 low potassium borosilicate glass that conforms to USP Type I and ASTM E 438 Type I, Class A requirements
- Background counts are consistent and low, ultraviolet transmission is high
- Screw caps can be purchased separately
- Packaged in 5 utility trays with each partitioned tray holding 100 vials each
- Utility trays serve as a way to store your samples
- For additional organization of your vials use the WHEATON Vial Rack 868806 or M-T Vial File® W228792



Cat. No.	Size (mL)	Cap Size	Dia. x H (mm)	Qty / Case
986532	20	22-400	28 x 57	500

Liquid Scintillation Vial Screw Caps

- Screw caps for WHEATON liquid scintillation vials
- Use as replacement caps or for vials that are provided without caps
- Choose the right size screw cap for your vial
- Select cap and liner material for your application
- Not autoclavable



Cat. No.	Cap Size (mm)	Cap Material	Cap Liner Material	Qty / Case
241009	15-425	Urea	Metal Foil	1000
240804	22-400	Polypropylene	Metal Foil	1000
241017	22-400	Urea	Metal Foil	1000
240817	22-400	Urea	Polyethylene Disc	1000
240917	22-400	Urea	PE Cone	1000
241317	22-400	Polyethylene	Linerless	1000
240805	24-400	Polypropylene	Foil / Pulp	1000
241018	24-400	Urea	Metal Foil	1000
240818	24-400	Urea	Polyethylene Disc	1000

Omni-Vial®, Polypropylene

- 4mL polypropylene vial for wide variety of lab applications
- Press-fit cap made from polypropylene
- Vials and caps are packed separately in two polybags containing 500 each
- Vial can be autoclaved for 15 minutes at 121°C at 15 psi



Cat. No.	Size (mL)	Liner Material	Dia. x H (mm)	Qty / Case
225402	4	Linerless	13 x 57	1000

Scintillation Vial, HDPE



Quarter Turn Cap



Quarter Turn Hanging Cap

- 6mL vial made from high density polyethylene
- Hanging cap allows for suspending vial in 20mL vial with 22mm neck finish
- Dimensions with cap attached: 17mm x 57mm
- For additional organization of your vials use the WHEATON Vial Rack 868810
- Polypropylene cap included

Cat. No.	Cap Type	Liner Material	Qty / Case
225414	Quarter Turn	Linerless	1000
225415	Quarter Turn Hanging Style	Linerless	1000

Sample® Vials

- 6mL vial made from glass or HDPE
- Glass vials made from WHEATON 180 low potassium borosilicate glass that conforms to ASTM E 438 Type I, Class A and USP Type I requirements
- Background counts are consistent and low in glass vials; ultraviolet transmission is high
- HDPE vials are economical choice for scintillation counting
- Caps packaged separately
- For additional organization of your vials use the WHEATON Vial Rack 868810



Cat. No.	Cap Material	Liner Material	Cap Size	Dia. x H (mm)	Qty / Case
Glass					
986491	Urea	Metal Foil / Pulp	13-425	17 x 58	1000
986492	Urea	Metal Foil / Pulp	15-425	17 x 58	1000
HDPE					
986644	Polypropylene	Linerless	18mm	17 x 57	1000
986645	Polypropylene	Linerless	18mm	17 x 57	2000

Culture Vial

- Culture vials feature deep-skirted screw caps to allow safer, more dependable handling when working with infectious materials
- Vials are manufactured from WHEATON 33 low extractable borosilicate glass that conforms to USP Type I and ASTM E 438 Type I, Class A requirements
- Pre-attached deep skirted solid-top black phenolic screw cap with 14B rubber liner
- Autoclavable
- Vials packaged in corrugated trays with partitions
- Use M-T Vial File® (Cat. No. 228780) for storing 4mL vials and (Cat. No. W228790) for storing 8mL vials



Cat. No.	Size (mL)	*Dia. x H (mm)	Cap Size	Qty / Case
225142	4	15 x 51	13-415	144
225144	8	17 x 70	15-415	144
225145	12	19 x 72	15-415	144

*Measurement taken with cap attached.

EPA Vial, 40mL

- Ideal for use in water sampling according to EPA 40 CFR 136, "Guidelines for Establishing Test Procedures for the Analysis of Pollutants"
- Clear vials manufactured from WHEATON 33 low extractable borosilicate glass that conforms to USP Type I and ASTM E438 Type I, Class A requirements
- Amber vials manufactured from WHEATON 320 amber glass that conforms to USP Type I requirements for light transmission to protect light-sensitive products
- Caps attached to vials
- Vials packaged in convenient trays for ease of use



Cat. No.	Size (mL)	Size (dr)	*Dia. x H (mm)	Cap Size	Qty / Case
Clear Vial with Open Top Black Phenolic PTFE Faced Silicone Lined Cap					
225310	40	10	28 x 98	24-400	72
Amber Vial with Open Top White Polypropylene PTFE Faced Silicone Lined Cap					
225315	40	10	28 x 98	24-400	72

*Measurement taken with cap attached.

Replacement 24-400 Screw Caps & Septa

Cat. No.	Description	Qty / Case
W240518	Black Phenolic Open Top Screw Cap w/o Septa	200
W224600	White Glass-Filled Open Top Polypropylene Cap with Bonded 5 mils PTFE / 120 mils Silicone Septa	200

Dilution Vial

- Vial is marked with a blue line at the 3mL level
- Vials are manufactured from WHEATON 33 low extractable borosilicate glass that conforms to USP Type I and ASTM E 438 Type I, Class A requirements
- Pre-attached solid-top black phenolic screw cap with 14B rubber liner
- Autoclavable
- Vials are packaged in corrugated trays with partitions
- Use M-T Vial File* (Cat. No. 228780) for storing vials



Cat. No.	Size (mL)	*Dia. x H (mm)	Cap Size	Qty / Case
225002	4	15 x 48	13-425	144

*Measurement taken with cap attached.

Vials for Environmental Analysis



Cat. No.	Size (mL)	Size (dr)	Dia. x H (mm)*	Cap Size	Qty / Case
Clear Vial with Open Top White Polypropylene PTFE Faced Silicone Lined Cap (Septa of 5 mils of PTFE facing 120 mils of silicone is bonded to cap.)					
W224609	20	5	28 x 60	24-400	72
W224610	25	6.25	28 x 73	24-400	72
Amber Vial with Open Top White Polypropylene PTFE Faced Silicone Lined Cap (Septa of 5 mils of PTFE facing 120 mils of silicone is bonded to cap.)					
W224612	20	5	28 x 60	24-400	72
W224614	40	10	28 x 98	24-400	72

*Cap on

Sample Vial Sizer Guide (Approximate Size)

-  Sample Vial in Lab File® (w/ cap attached)
-  Sample Vial in Lab File® w/ Writing Patch (w/ cap attached)
-  Sample Vial in Lab File® (w/o cap attached)
-  Sample Vial in Vial File® (w/ cap attached)
-  E-C Sample Vial

Standard Sample Vials

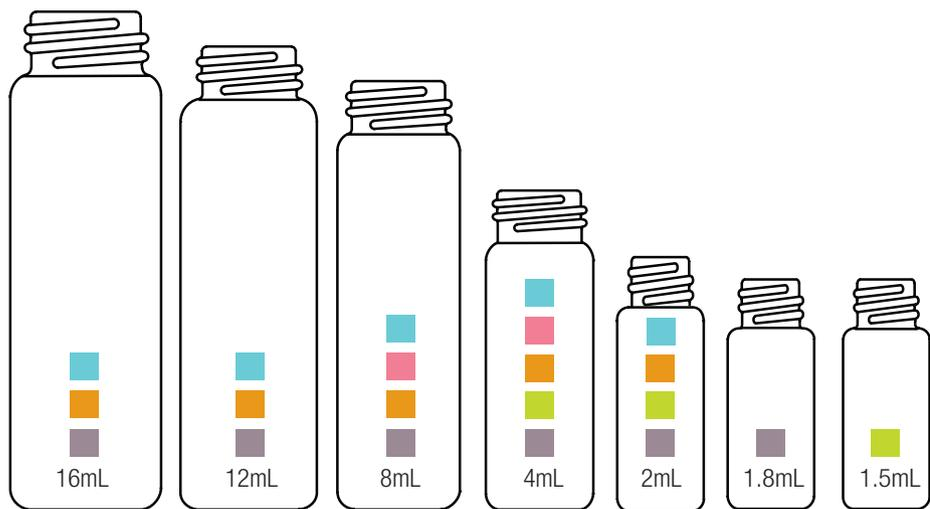

Shorty Vials®

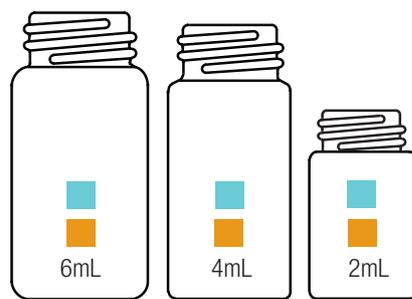

Standard Sample Vials



Sample Vials in Lab File® (With Caps Attached)



Shorty Vials*



Standard Clear and Amber Vials

- Sample vials with caps attached to vial help maintain cleanliness
- Lab File® with partitioned trays provides an easy way to inventory samples or to store empty vials
- Clear vials made from low extractable borosilicate glass to provide superior chemical resistance
- Clear vials conform to USP Type I and ASTM E 438 Type I, Class A requirements
- Amber vials made from borosilicate glass that conforms to USP Type I requirements for light transmission
- Shorty Vials* feature a low profile for greater stability and less dead volume
- 14B rubber lined black phenolic screw cap for aqueous samples
- PTFE / 14B rubber lined black phenolic screw cap for organic samples
- Replacement caps can be purchased separately
- Vials and caps are autoclavable

Cat. No.	Color	Size (mL)	Size (dr)	Cap Material	Cap Description	Liner Material	Cap Size	Dia. x H (mm)	Qty / Case	Fits M-T File®	Fits Vial Rack
Shorty Vials with Caps Attached											
W225291	Clear	2	.5	Black Phenolic	Solid Top	14B Rubber	13-425	15 x 31	200	228780	868804
W224606	Clear	2	.5	Black Phenolic	Solid Top	PTFE / 14B Rubber	13-425	15 x 31	200	228780	868804
W225292	Clear	4	1	Black Phenolic	Solid Top	14B Rubber	15-425	17 x 41	200	—	868810
W224607	Clear	4	1	Black Phenolic	Solid Top	PTFE / 14B Rubber	15-425	17 x 41	200	—	868810
W225293	Clear	6	1.5	Black Phenolic	Solid Top	14B Rubber	15-425	19 x 43	200	—	—
W224608	Clear	6	1.5	Black Phenolic	Solid Top	PTFE / 14B Rubber	15-425	19 x 43	200	—	—
Standard Vials with Caps Attached											
224881	Clear	2	.5	Black Phenolic	Solid Top	14B Rubber	8-425	12 x 38	288	228778	985800
W224581	Clear	2	.5	Black Phenolic	Solid Top	PTFE / 14B Rubber	8-425	12 x 38	288	228778	985800
224981	Amber	2	.5	Black Phenolic	Solid Top	14B Rubber	8-425	12 x 38	288	228778	985800
W224681	Amber	2	.5	Black Phenolic	Solid Top	PTFE / 14B Rubber	8-425	12 x 38	288	228778	985800
225081	Clear	2	.5	White Urea	Solid Top	Metal Foil / Pulp	8-425	12 x 38	288	228778	985800
224882	Clear	4	1	Black Phenolic	Solid Top	14B Rubber	13-425	15 x 48	144	228780	868804
W224582	Clear	4	1	Black Phenolic	Solid Top	PTFE / 14B Rubber	13-425	15 x 48	144	228780	868804
224982	Amber	4	1	Black Phenolic	Solid Top	14B Rubber	13-425	15 x 48	144	228780	868804
W224682	Amber	4	1	Black Phenolic	Solid Top	PTFE / 14B Rubber	13-425	15 x 48	144	228780	868804
224884	Clear	8	2	Black Phenolic	Solid Top	14B Rubber	15-425	17 x 63	144	W228790	868810
W224584	Clear	8	2	Black Phenolic	Solid Top	PTFE / 14B Rubber	15-425	17 x 63	144	W228790	868810
224984	Amber	8	2	Black Phenolic	Solid Top	14B Rubber	15-425	17 x 63	144	W228790	868810
W224684	Amber	8	2	Black Phenolic	Solid Top	PTFE / 14B Rubber	15-425	17 x 63	144	W228790	868810
224885	Clear	12	3	Black Phenolic	Solid Top	14B Rubber	15-425	19 x 68	144	—	—
W224585	Clear	12	3	Black Phenolic	Solid Top	PTFE / 14B Rubber	15-425	19 x 68	144	—	—
224886	Clear	16	4	Black Phenolic	Solid Top	14B Rubber	18-400	21 x 73	144	—	—
W224586	Clear	16	4	Black Phenolic	Solid Top	PTFE / 14B Rubber	18-400	21 x 73	144	—	—
225288	Clear	20	5	Black Phenolic	Solid Top	14B Rubber	24-400	28 x 60	72	W228792	868806
W224589	Clear	20	5	Black Phenolic	Solid Top	PTFE / 14B Rubber	24-400	28 x 60	72	W228792	868806
W224820	Amber	20	5	Black Phenolic	Solid Top	14B Rubber	24-400	28 x 60	72	W228792	868806
W224604	Amber	20	5	Black Phenolic	Solid Top	PTFE / 14B Rubber	24-400	28 x 60	72	W228792	868806
224888	Clear	24	6	Black Phenolic	Solid Top	14B Rubber	20-400	23 x 88	144	—	868805
W224588	Clear	24	6	Black Phenolic	Solid Top	PTFE / 14B Rubber	20-400	23 x 88	144	—	868805
225289	Clear	25	6.76	Black Phenolic	Solid Top	14B Rubber	24-400	28 x 73	72	—	868806
W224590	Clear	25	6.76	Black Phenolic	Solid Top	PTFE / 14B Rubber	24-400	28 x 73	72	—	868806
225290	Clear	40	10.8	Black Phenolic	Solid Top	14B Rubber	24-400	28 x 98	72	—	868806
W224591	Clear	40	10.8	Black Phenolic	Solid Top	PTFE / 14B Rubber	24-400	28 x 98	72	—	868806
W224840	Amber	40	10.8	Black Phenolic	Solid Top	14B Rubber	24-400	28 x 98	72	—	868806
W224605	Amber	40	10.8	Black Phenolic	Solid Top	PTFE / 14B Rubber	24-400	28 x 98	72	—	868806
Standard Vials with Writing Patch and Caps Attached											
225012	Clear	4	1	Black Phenolic	Solid Top	14B Rubber	13-425	15 x 48	144	228780	868804
225014	Clear	8	2	Black Phenolic	Solid Top	14B Rubber	15-425	17 x 63	144	W228790	868810

Sample Vials in Lab File® (Without Caps)

- Sample vials packaged in partitioned trays without caps
- Partitioned trays provide an easy way to inventory samples or to store empty vials
- Clear vials made from low extractable borosilicate glass that provides superior chemical resistance
- Clear vials conform to USP Type I and ASTM E 438 Type I, Class A requirements
- Amber vials made from borosilicate glass that conforms to USP Type I requirements for light transmission to protect light-sensitive products
- Shorty Vials® feature a low profile for greater stability and less dead volume
- Screw caps can be purchased separately
- Vials are autoclavable

Cat. No.	Color	Size (mL)	Size (dr)	Cap Size	Dia. x H (mm)	Qty / Case	Fits M-T File®	Fits Vial Rack
Shorty Vials without Caps								
224821	Clear	2	.5	13-425	15 x 28	200	228780	868804
224822	Clear	4	1	15-425	17 x 38	200	—	868810
224823	Clear	6	1.5	15-425	19 x 40	200	—	—
Standard Vials without Caps								
224801	Clear	2	.5	8-425	12 x 35	200	228778	985800
224811	Amber	2	.5	8-425	12 x 35	200	228778	985800
224802	Clear	4	1	13-425	15 x 45	200	228780	868804
224812	Amber	4	1	13-425	15 x 45	200	228780	868804
224804	Clear	8	2	15-425	17 x 60	200	W228790	868810
224814	Amber	8	2	15-425	17 x 60	200	W228790	868810
224805	Clear	12	3	15-425	19 x 65	200	—	—
224806	Clear	16	4	18-400	21 x 70	200	—	—
224831	Clear	20	5	24-400	28 x 57	200	W228792	868806
W224815	Amber	20	5	24-400	28 x 57	200	W228792	868806
224808	Clear	24	6	20-400	23 x 85	200	—	868805
224832	Clear	25	6.76	24-400	28 x 70	200	—	868806
W224834	Clear	30	8	22-400	25 x 95	200	—	—
224833	Clear	40	10.8	24-400	28 x 95	200	—	868806
224836	Amber	40	10.8	24-400	28 x 95	200	—	868806

Sample Vials in Vial File®



224891



224892



W224896

- Provides a compact, easily accessible means of sample storage
- Polystyrene case with partitions, foam inserts and alphanumeric indexing card organize and protect vials
- Clear vials are manufactured from low extractable borosilicate glass that conforms to USP Type I and ASTM E 438 Type I, Class A requirements
- Amber vials made from borosilicate glass that conforms to USP Type I requirements for light transmission to protect light-sensitive products
- Choice of solid or open top black phenolic screw cap
- Open top screw cap provides for sample retrieval with a syringe
- Caps attached to vials
- Vials and caps are autoclavable

Cat. No.	Color	Size (mL)	Size (dr)	Graduations	Cap Style	Cap Material	Liner Material	Cap Size	Dia. x H (mm)	Vials/File	Qty / Case
224950	Clear	1.5	.375	No	Open Top	Black Phenolic	PTFE / Silicone	8-425	12 x 35	60	1
W224954	Amber	1.5	.375	No	Open Top	Black Phenolic	PTFE / Silicone	8-425	12 x 35	60	1
224891	Clear	2	.5	No	Solid Top	Black Phenolic	14B Rubber	8-425	12 x 38	60	1
W224693	Clear	2	.5	No	Solid Top	Black Phenolic	PTFE / 14B Rubber	8-425	12 x 38	60	1
W224896	Amber	2	.5	No	Solid Top	Black Phenolic	14B Rubber	8-425	12 x 38	60	1
W224695	Amber	2	.5	No	Solid Top	Black Phenolic	PTFE / 14B Rubber	8-425	12 x 38	60	1
224892	Clear	4	1	No	Solid Top	Black Phenolic	14B Rubber	13-425	15 x 48	40	1
W224694	Clear	4	1	No	Solid Top	Black Phenolic	PTFE / 14B Rubber	13-425	15 x 48	40	1
224952	Clear	4	1	No	Open Top	Black Phenolic	PTFE / Silicone	13-425	15 x 48	40	1
W224897	Amber	4	1	No	Solid Top	Black Phenolic	14B Rubber	13-425	15 x 48	40	1
W224696	Amber	4	1	No	Solid Top	Black Phenolic	PTFE / 14B Rubber	13-425	15 x 48	40	1
W224955	Amber	4	1	No	Open Top	Black Phenolic	PTFE / Silicone	13-425	15 x 48	40	1

E-C Sample Vials



- E-Conomically priced by packaging vials and screw caps separately
- Clear vials made from low extractable borosilicate glass that provides superior chemical resistance
- Clear vials conform to USP Type I and ASTM E 438 Type I, Class A requirements
- Amber vials made from borosilicate glass that conforms to USP Type I requirements for light transmission to protect light-sensitive products
- Vials packed in two shrink-wrapped packs of 100 vials which reduces contamination from corrugate
- 14B rubber lined black phenolic screw cap for aqueous samples
- PTFE-faced 14B rubber lined black phenolic screw cap for organic samples
- Caps and replacement caps can be purchased separately
- Vials and caps are autoclavable

Cat. No.	Color	Size (mL)	Size (dr)	Cap Material	Liner Material	Cap Size	Dia. x H (mm)	Qty / Case	Fits M-T File*	Fits Vial Rack
224700	Clear	1.8	.375	—	—	8-425	12 x 32	200	228778	985800
224710	Amber	1.8	.375	—	—	8-425	12 x 32	200	228778	985800
224720	Clear	1.8	.375	Black Phenolic	14B Rubber	8-425	12 x 35**	200	228778	985800
224740	Clear	1.8	.375	Black Phenolic	PTFE / 14B Rubber	8-425	12 x 35**	200	228778	985800
224730	Amber	1.8	.375	Black Phenolic	14B Rubber	8-425	12 x 35**	200	228778	985800
224750	Amber	1.8	.375	Black Phenolic	PTFE / 14B Rubber	8-425	12 x 35**	200	228778	985800
224701	Clear	2	.5	—	—	8-425	12 x 35	200	228778	985800
224711	Amber	2	.5	—	—	8-425	12 x 35	200	228778	985800
224721	Clear	2	.5	Black Phenolic	14B Rubber	8-425	12 x 38**	200	228778	985800
224741	Clear	2	.5	Black Phenolic	PTFE / 14B Rubber	8-425	12 x 38**	200	228778	985800
224731	Amber	2	.5	Black Phenolic	14B Rubber	8-425	12 x 38**	200	228778	985800
224751	Amber	2	.5	Black Phenolic	PTFE / 14B Rubber	8-425	12 x 38**	200	228778	985800
224702	Clear	4	1	—	—	13-425	15 x 45	200	228780	868804
224712	Amber	4	1	—	—	13-425	15 x 45	200	228780	868804
224722	Clear	4	1	Black Phenolic	14B Rubber	13-425	15 x 48**	200	228780	868804
224742	Clear	4	1	Black Phenolic	PTFE / 14B Rubber	13-425	15 x 48**	200	228780	868804
224732	Amber	4	1	Black Phenolic	14B Rubber	13-425	15 x 48**	200	228780	868804
224752	Amber	4	1	Black Phenolic	PTFE / 14B Rubber	13-425	15 x 48**	200	228780	868804
224704	Clear	8	2	—	—	15-425	17 x 60	200	W228790	868810
224714	Amber	8	2	—	—	15-425	17 x 60	200	W228790	868810
224724	Clear	8	2	Black Phenolic	14B Rubber	15-425	17 x 63**	200	W228790	868810
224744	Clear	8	2	Black Phenolic	PTFE / 14B Rubber	15-425	17 x 63**	200	W228790	868810
224734	Amber	8	2	Black Phenolic	14B Rubber	15-425	17 x 63**	200	W228790	868810
224754	Amber	8	2	Black Phenolic	PTFE / 14B Rubber	15-425	17 x 63**	200	W228790	868810
224705	Clear	12	3	—	—	15-425	19 x 65	200	—	—
224725	Clear	12	3	Black Phenolic	14B Rubber	15-425	19 x 68**	200	—	—
224745	Clear	12	3	Black Phenolic	PTFE / 14B Rubber	15-425	19 x 68**	200	—	—
224706	Clear	16	4	—	—	18-400	21 x 70	200	—	—
224726	Clear	16	4	Black Phenolic	14B Rubber	18-400	21 x 73**	200	—	—
224746	Clear	16	4	Black Phenolic	PTFE / 14B Rubber	18-400	21 x 73**	200	—	—
W224809	Clear	20	5	—	—	24-400	28 x 57	200	W228792	868806
224708	Clear	24	6	—	—	20-400	23 x 85	200	—	868805
224728	Clear	24	6	Black Phenolic	14B Rubber	20-400	23 x 88**	200	—	868805
224748	Clear	24	6	Black Phenolic	PTFE / 14B Rubber	20-400	23 x 88**	200	—	868805
W224810	Clear	40	10.8	—	—	24-400	28 x 95	200	—	868806
W226060*	Clear	60	15	—	—	24-400	30 x 125	143	—	868808

* Includes one shrink-wrapped pack of 143 vials

** Measurement with cap attached

Screw Caps for Sample Vials



Black Phenolic



White Polypropylene Solid Top



White Polypropylene Open Top

- Choice of black phenolic, white polypropylene or urea screw caps
- PTFE faced (14B) styrene-butadiene rubber liner provides a totally inert inner seal and surface facing the sample or product
- Bonded PTFE faced silicone liner ideal for storage of volatile solvents, sensitive compounds and corrosive chemicals
- Open top screw caps have a bonded PTFE faced silicone liner that provides access with a syringe
- Pre-slit PTFE / Silicone liner easily pierced by liquid handling needles
- Can withstand autoclaving / sterilization

Cat. No.	Cap Size	Cap Style	Cap Material	Color	Cap Liner	Autoclavable	Qty / Case
240206	8-425	Solid Top	Phenolic	Black	14B Rubber	Yes	1000
W240406	8-425	Solid Top	Phenolic	Black	PTFE / 14B Rubber	Yes	200
240208	13-425	Solid Top	Phenolic	Black	14B Rubber	Yes	200
240408	13-425	Solid Top	Phenolic	Black	PTFE / 14B Rubber	Yes	200
239249	13-425	Solid Top	Phenolic	Black	PE Cone	No	144
239201	13-425	Solid Top	Polypropylene	White	Poly-Vinyl	No	144
239273	13-425	Solid Top	Polypropylene	White	Foamed PE	No	144
239225	13-425	Solid Top	Polypropylene	White	PTFE / Foamed PE	No	144
W240830	13-425	Solid Top	Polypropylene	White	Bonded PTFE / Silicone	Yes	250
W242710	13-425	Open Top	Polypropylene	Black	Bonded PTFE / Silicone	Yes	250
W240848	13-425	Open Top	Polypropylene	Black	Pre-Slit Bonded PTFE / Silicone	Yes	250
240209	15-425	Solid Top	Phenolic	Black	14B Rubber	Yes	200
240409	15-425	Solid Top	Phenolic	Black	PTFE / 14B Rubber	Yes	200
239250	15-425	Solid Top	Phenolic	Black	PE Cone	No	144
239202	15-425	Solid Top	Polypropylene	White	Poly-Vinyl	No	144
239274	15-425	Solid Top	Polypropylene	White	Foamed PE	No	144
239226	15-425	Solid Top	Polypropylene	White	PTFE / Foamed PE	No	144
W240832	15-425	Solid Top	Polypropylene	White	Bonded PTFE / Silicone	Yes	250
W240842	15-425	Open Top	Polypropylene	White	Bonded PTFE / Silicone	Yes	250
W240850	15-425	Open Top	Polypropylene	Black	Pre-Slit Bonded PTFE / Silicone	Yes	250
241009	15-425	Closed Top	Urea	White	Metal Foil	No	1000
240215	18-400	Solid Top	Phenolic	Black	14B Rubber	Yes	500
240415	18-400	Solid Top	Phenolic	Black	PTFE / 14B Rubber	Yes	200
239251	18-400	Solid Top	Phenolic	Black	PE Cone	No	144
239203	18-400	Solid Top	Polypropylene	White	Poly-Vinyl	No	144
239275	18-400	Solid Top	Polypropylene	White	Foamed PE	No	144
239227	18-400	Solid Top	Polypropylene	White	PTFE / Foamed PE	No	144
W239298	20-400	Solid Top	Phenolic	Black	14B Rubber	Yes	144
240416	20-400	Solid Top	Phenolic	Black	PTFE / 14B Rubber	Yes	100
239253	20-400	Solid Top	Phenolic	Black	PE Cone	No	144
239229	20-400	Solid Top	Polypropylene	White	PTFE / Foamed PE	No	144
W239300	24-400	Solid Top	Phenolic	Black	14B Rubber	Yes	144
240418	24-400	Solid Top	Phenolic	Black	PTFE / 14B Rubber	Yes	100
W242711	24-400	Solid Top	Phenolic	Black	PTFE / 14B Rubber	Yes	200
239257	24-400	Solid Top	Phenolic	Black	PE Cone	No	144
239209	24-400	Solid Top	Polypropylene	White	Poly-Vinyl	No	144
239281	24-400	Solid Top	Polypropylene	White	Foamed PE	No	144
239233	24-400	Solid Top	Polypropylene	White	PTFE / Foamed PE	No	144
W240836	24-400	Solid Top	Polypropylene	White	Bonded PTFE / Silicone	Yes	100
W240846	24-400	Open Top	Polypropylene	White	Bonded PTFE / Silicone	Yes	100
241018	24-400	Solid Top	Urea	White	Metal Foil	No	1000

E-Z Ex-Traction® Vials

- Conical well ensures maximum sample recovery
- Quality engineered for automated sample handling systems
- Excellent for chemical compound or biological sample storage
- Made from low extractable borosilicate glass that conforms to USP Type I and ASTM E 438 Type I, Class A requirements
- Vials can be easily bar coded using our customized services
- Screw caps can be purchased separately



Cat. No.	Color	Size (mL)	Size (dr)	Dia. x H (mm)	Cap Size	Qty / Case
W224601	Clear	2	.5	15 x 32	13-425	250
W224603	Clear	2	.5	15 x 32	13-425	1000
W224613	Clear	4	1	15 x 45	13-425	250
W224617	Clear	4	1	15 x 45	13-425	1000
W224618	Clear	8	2	16.75 x 60	15-425	250
W224619	Clear	8	2	16.75 x 60	15-425	1000
W224634	Clear	20	5	26.5 x 67	24-400	100
W224636	Clear	20	5	26.5 x 67	24-400	500

E-Z Ex-Traction® Vial Screw Caps

- Choice of black phenolic or white polypropylene screw caps
- PTFE faced (14B) styrene-butadiene rubber liner provides an inert inner seal and surface facing the sample or product
- Bonded PTFE faced silicone liner ideal for storage of volatile solvents, sensitive compounds and corrosive chemicals
- Open top screw caps have a bonded PTFE faced silicone liner that provides access with a syringe
- Pre-slit PTFE silicone liner easily pierced by liquid handling needles
- Can withstand autoclaving / sterilization



**Black Phenolic
Solid Top Cap**



**White Polypropylene
Open Top Cap**

Cat. No.	Cap Size	Cap Style	Cap Material	Color	Cap Liner	Qty / Pack	Qty / Case
W240820	13-425	Solid Top	Phenolic	Black	PTFE / 14B Rubber	250	250
W240821	13-425	Solid Top	Phenolic	Black	PTFE / 14B Rubber	250	1000
W240830	13-425	Solid Top	Polypropylene	White	Bonded PTFE / Silicone	250	250
W240831	13-425	Solid Top	Polypropylene	White	Bonded PTFE / Silicone	250	1000
W242710	13-425	Open Top	Polypropylene	Black	Bonded PTFE / Silicone	250	250
W240840	13-425	Open Top	Polypropylene	White	Bonded PTFE / Silicone	250	250
W240841	13-425	Open Top	Polypropylene	White	Bonded PTFE / Silicone	250	1000
W240848	13-425	Open Top	Polypropylene	Black	Pre-Slit Bonded PTFE / Silicone	250	250
W240849	13-425	Open Top	Polypropylene	Black	Pre-Slit Bonded PTFE / Silicone	250	1000
W240822	15-425	Solid Top	Phenolic	Black	PTFE / 14B Rubber	250	250
W240823	15-425	Solid Top	Phenolic	Black	PTFE / 14B Rubber	250	1000
W240832	15-425	Solid Top	Polypropylene	White	Bonded PTFE / Silicone	250	250
W240833	15-425	Solid Top	Polypropylene	White	Bonded PTFE / Silicone	250	1000
W240842	15-425	Open Top	Polypropylene	White	Bonded PTFE / Silicone	250	250
W240843	15-425	Open Top	Polypropylene	White	Bonded PTFE / Silicone	250	1000
W240850	15-425	Open Top	Polypropylene	Black	Pre-Slit Bonded PTFE / Silicone	250	250
W240851	15-425	Open Top	Polypropylene	Black	Pre-Slit Bonded PTFE / Silicone	250	1000
W240824	22-400	Solid Top	Phenolic	Black	PTFE / 14B Rubber	100	100
W240825	22-400	Solid Top	Phenolic	Black	PTFE / 14B Rubber	100	500
W240834	22-400	Solid Top	Polypropylene	White	Bonded PTFE / Silicone	100	100
W240835	22-400	Solid Top	Polypropylene	White	Bonded PTFE / Silicone	100	500
W240844	22-400	Open Top	Polypropylene	White	Bonded PTFE / Silicone	100	100
W240845	22-400	Open Top	Polypropylene	White	Bonded PTFE / Silicone	100	500
240418	24-400	Solid Top	Phenolic	Black	PTFE / 14B Rubber	100	100
W240827	24-400	Solid Top	Phenolic	Black	PTFE / 14B Rubber	100	500
W240836	24-400	Solid Top	Polypropylene	White	Bonded PTFE / Silicone	100	100
W240837	24-400	Solid Top	Polypropylene	White	Bonded PTFE / Silicone	100	500
W240846	24-400	Open Top	Polypropylene	White	Bonded PTFE / Silicone	100	100
W240847	24-400	Open Top	Polypropylene	White	Bonded PTFE / Silicone	100	500

NextGen™ V Vials®



- Conical interior provides downward drainage for maximum sample retrieval
- Ideal for small-scale reactions, centrifugation, storage, packaging and shipping
- Low particulate packaging protects against contamination during transportation and storage
- Clear vials conform to USP Type I and ASTM E 438 Type I, Class A requirements
- Amber vials made from amber borosilicate glass that conforms to USP Type I requirements for light transmission to protect light-sensitive products
- Graduated or non-graduated
- Choose screw thread or crimp / serum finish
- Closures for crimp / serum finish vials can be purchased separately

Spin Vanes

- Magnetic stir bar for use with NextGen™ V Vials®
- Made from PTFE
- Place stir bar in vial and use with magnetic stirrer



Cat. No.	Description	Qty / Case
903061	Fits 0.3 and 1.0mL V Vials	6
903063	Fits 2, 3, 5 and 10mL V Vials	6

Cat. No.	Color	Size (mL)	Graduated	Cap Style	Cap Material	Cap Color	Liner Material	Cap Size	Dia. x H (mm)	Qty / Case
W986281NG	Clear	0.1	No	Open Top, Screw Cap	Phenolic	Black	PTFE / Silicone	8-425	12 x 35	12
W986211NG*	Clear	0.1	No	Crimp Top, purchase closure separately	—	—	—	11mm	12 x 32	12
W986273NG	Clear	0.3	Yes	Solid Top, Screw Cap	Phenolic	Black	PTFE / 14B Rubber	13-425	13 x 35	12
W986253NG	Clear	0.3	No	Solid Top, Screw Cap	Phenolic	Black	PTFE / 14B Rubber	13-425	13 x 35	12
W986282NG	Clear	0.3	No	Open Top, Screw Cap	Phenolic	Black	PTFE / Silicone	8-425	12 x 35	12
W986283NG	Clear	0.3	No	Open Top, Screw Cap	Phenolic	Black	PTFE / Silicone	13-425	13 x 35	12
W986293NG	Clear	0.3	Yes	Open Top, Screw Cap	Phenolic	Black	PTFE / Silicone	13-425	13 x 35	12
W986212NG*	Clear	0.3	No	Crimp Top, purchase closure separately	—	—	—	11mm	12 x 32	12
W986213NG*	Clear	0.3	No	Crimp Top, purchase closure separately	—	—	—	13mm	13 x 32	12
W986274NG	Clear	1.0	Yes	Solid Top, Screw Cap	Phenolic	Black	PTFE / 14B Rubber	13-425	13 x 44	12
W986254NG	Clear	1.0	No	Solid Top, Screw Cap	Phenolic	Black	PTFE / 14B Rubber	13-425	13 x 44	12
W986284NG	Clear	1.0	No	Open Top, Screw Cap	Phenolic	Black	PTFE / Silicone	13-425	13 x 44	12
W986294NG	Clear	1.0	Yes	Open Top, Screw Cap	Phenolic	Black	PTFE / Silicone	13-425	13 x 44	12
W986334NG	Amber	1.0	No	Solid Top, Screw Cap	Phenolic	Black	PTFE / 14B Rubber	13-425	13 x 44	12
W986354NG	Amber	1.0	No	Open Top, Screw Cap	Phenolic	Black	PTFE / Silicone	13-425	13 x 44	12
W986314NG*	Amber	1.0	No	Screw Cap, purchase closure separately	—	—	—	13-425	13 x 41	12
W986214NG*	Clear	1.0	No	Crimp Top, purchase closure separately	—	—	—	13mm	13 x 41	12
W986276NG	Clear	2.0	Yes	Solid Top, Screw Cap	Phenolic	Black	PTFE / 14B Rubber	15-415	17 x 61	12
W986272NG	Clear	2.0	Yes	Solid Top, Screw Cap	Phenolic	Black	PTFE / 14B Rubber	20-400	20 x 44	12
W986256NG	Clear	2.0	No	Solid Top, Screw Cap	Phenolic	Black	PTFE / 14B Rubber	15-415	17 x 61	12
W986261NG	Clear	2.0	No	Solid Top, Screw Cap	Phenolic	Black	PTFE / 14B Rubber	20-400	20 x 44	12
W986288NG	Clear	2.0	No	Open Top, Screw Cap	Phenolic	Black	PTFE / Silicone	20-400	20 x 44	12
W986298NG	Clear	2.0	Yes	Open Top, Screw Cap	Phenolic	Black	PTFE / Silicone	20-400	20 x 44	12
W986336NG	Amber	2.0	No	Solid Top, Screw Cap	Phenolic	Black	PTFE / 14B Rubber	20-400	20 x 44	12
W986356NG	Amber	2.0	No	Open Top, Screw Cap	Phenolic	Black	PTFE / Silicone	20-400	20 x 44	12
W986316NG*	Amber	2.0	No	Screw Cap, purchase closure separately	—	—	—	20-400	20 x 41	12
W986216NG*	Clear	2.0	No	Crimp Top, purchase closure separately	—	—	—	20mm	20 x 40	12
W986277NG	Clear	3.0	Yes	Solid Top, Screw Cap	Phenolic	Black	PTFE / 14B Rubber	20-400	20 x 50	12
W986257NG	Clear	3.0	No	Solid Top, Screw Cap	Phenolic	Black	PTFE / 14B Rubber	20-400	20 x 50	12
W986287NG	Clear	3.0	No	Open Top, Screw Cap	Phenolic	Black	PTFE / Silicone	20-400	20 x 50	12
W986297NG	Clear	3.0	Yes	Open Top, Screw Cap	Phenolic	Black	PTFE / Silicone	20-400	20 x 50	12
W986217NG*	Clear	3.0	No	Crimp Top, purchase closure separately	—	—	—	20mm	20 x 46	12
W986279NG	Clear	5.0	Yes	Solid Top, Screw Cap	Phenolic	Black	PTFE / 14B Rubber	20-400	20 x 65	12
W986259NG	Clear	5.0	No	Solid Top, Screw Cap	Phenolic	Black	PTFE / 14B Rubber	20-400	20 x 65	12
W986289NG	Clear	5.0	No	Open Top, Screw Cap	Phenolic	Black	PTFE / Silicone	20-400	20 x 65	12
W986299NG	Clear	5.0	Yes	Open Top, Screw Cap	Phenolic	Black	PTFE / Silicone	20-400	20 x 65	12
W986339NG	Amber	5.0	No	Solid Top, Screw Cap	Phenolic	Black	PTFE / 14B Rubber	20-400	20 x 65	12
W986359NG	Amber	5.0	No	Open Top, Screw Cap	Phenolic	Black	PTFE / Silicone	20-400	20 x 65	12
W986319NG*	Amber	5.0	No	Screw Cap, purchase closure separately	—	—	—	20-400	20 x 62	12
W986219NG*	Clear	5.0	No	Crimp Top, purchase closure separately	—	—	—	20mm	20 x 61	12
W986260NG	Clear	10.0	No	Solid Top, Screw Cap	Phenolic	Black	PTFE / 14B Rubber	24-400	25.4 x 72	6
W986290NG	Clear	10.0	No	Open Top, Screw Cap	Phenolic	Black	PTFE / Silicone	24-400	25.4 x 72	6

* Purchase closures separately.

Serum Tubing Vials



- 2 - 20mL size
- Clear vials manufactured from low extractable borosilicate glass that conforms to USP Type I and ASTM E 438 Type I, Class A requirements
- Amber glass conforms to USP Type I requirements to protect light-sensitive samples
- Tubular design provides excellent clarity and dimensional consistency from vial to vial
- Specially designed bottom radius adds strength for lyophilization applications
- Lighter weight compared to molded bottles
- Shrink-wrapped modules reduce particulate contamination
- Autoclavable

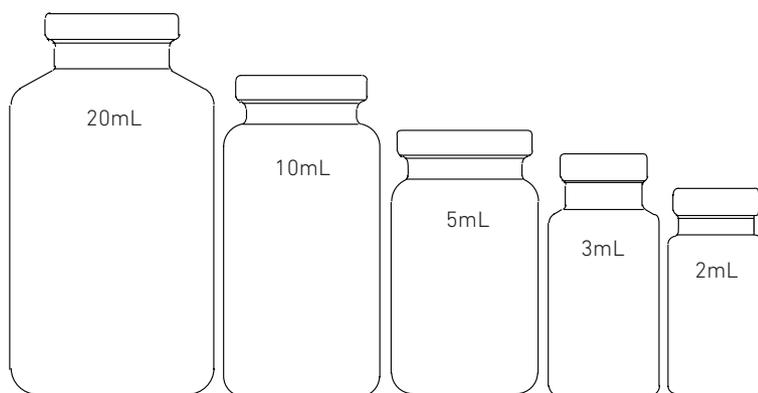

Serum Vial Approximate Size

Cat. No.	Size (mL)	Mouth ID x OD (mm)	Dia. x H	Qty / Case	Fits Rack
Clear Serum Vials					
223683	2	7 x 13	15 x 32	144	868804
223684	3	7 x 13	17 x 38	144	868810
223685	5	13 x 20	22 x 40	144	868805
223686	10	13 x 20	24 x 50	144	—
223687	20	13 x 20	30.5 x 58	120	—
Amber Serum Vials					
223693	2	7 x 13	15 x 32	144	868804
223695	5	13 x 20	22 x 40	144	868805
223696	10	13 x 20	24 x 50	144	—

Note: When selecting a rubber stopper or aluminum seal, match the mouth OD dimension of the vial.

Vacule® Vial

- Heavy wall construction designed for lyophilization and freeze-drying applications
- Screw threads eliminate use of crimp seal
- Manufactured from WHEATON 33 low extractable clear borosilicate glass that conforms to USP Type I and ASTM E 438 Type I, Class A requirements

Cat. No.	Size (mL)	Dia. x H (mm)	Cap Finish Size	Fits Rack	Qty / Case
Vacule® Vial					
651954*	4	17 x 45	15-425	868810	200
651905	5	22 x 40	22-350	868805	200
651907	10	22 x 55	22-350	868805	200

Cat. No.	Description	Qty / Pack	Qty / Case
Screw Caps and Stoppers for Cat. No. 651954			
224100-080	Red Rubber Stopper	100	1000
W224100-093	Lyophilization Stopper, 2-Leg	100	1000
240209	Cap, Solid Top, Screw Thread	200	200
W240509	Cap, Open Top, Screw Thread	200	200
Screw Caps and Stoppers for Cat. No. 651905 and 651907			
224100-172	Red Rubber Stoppers	100	1000
W224100-193	Lyophilization Stopper, 2-Leg	100	1000
W224100-202	Lyophilization Stopper, 3-Leg	100	1000
239853	Cap, Solid Top, Screw Thread	500	500

*Purchase closures separately

Serum Bottle, PVC Dropper Tip

- Create a dropper container using a crimp / serum bottle with 20mm mouth OD
- Dropper tip is made from PVC with HDPE closure
- Dispenses 40µL drop using water



Part. No.	Description	Dia. x H (mm)	Qty / Case
224080	PVC Dropper Tip	23 x 44	100

- Vacule vials have controlled ID, for accurate stopper fit
- Choice of solid or open top screw cap
- Stoppers and accessories listed below
- 651905 and 651907 are supplied with unlined black phenolic cap





Diagnostic Vials

- Alternative to serum bottles and vials
- Screw thread design eliminates need for crimping tools
- Ideal for lyophilization
- Fits with I-Loc™ closure or screw cap with thin flange stopper
- Tubular design provides excellent clarity and dimensional consistency from vial to vial
- Heavy walled glass provides impact resistance



Cat No.	Color	Size (mL)	Dia. x H (mm)	Cap Size	Qty / Case
W219365	Clear	5	22 x 38	20-400	480
W216375	Amber	5	22 x 38	20-400	480
W219366	Clear	10	22 x 55	20-400	480
W216376	Amber	10	22 x 55	20-400	480
W216377	Amber	20	30 x 52	20-400	480
W216378	Amber	30	30 x 69	20-400	288

I-Loc™ Closure

- For use with Screw Neck Diagnostic Bottles
- Advantages of an aluminum seal with the convenience of a screw cap
- Polypropylene screw cap with gray bromobutyl / 50 stopper
- Autoclavable



Cat. No.	Color	Cap Size	Qty / Case
240676-01	Black	20-400	100
240676-02	White	20-400	100
240676-03	Red	20-400	100
240676-04	Blue	20-400	100
240676-05	Yellow	20-400	100

Screw Caps for Screw Neck Diagnostic Bottles



- Polypropylene screw caps in 5 colors
- Use with 224100-203 or W224100-190 thin flange stopper
- Autoclavable

Cat. No.	Cap Size	Cap Style	Color	Autoclavable	Qty / Case
240706-01	20-400	Solid Top	Black	Yes	300
240706-02	20-400	Solid Top	White	Yes	300
240706-04	20-400	Solid Top	Blue	Yes	300
240706-05	20-400	Solid Top	Yellow	Yes	300
240716-01	20-400	Open-Top	Black	Yes	300
240716-02	20-400	Open-Top	White	Yes	300
240716-03	20-400	Open-Top	Red	Yes	300
240716-04	20-400	Open-Top	Blue	Yes	300
240716-05	20-400	Open-Top	Yellow	Yes	300

Stopper, Thin Flange

- Use with screw caps for Screw Neck Diagnostic Bottles
- Autoclavable



Cat. No.	Stopper Size	Qty / Case
224100-203	20mm 3-Leg Lyophilization Gray Chlorbutyl / 55	300
W224100-190	20mm Thin Flange Snap-On Gray Chlorbutyl / 49	300

Vial Racks



9.5mm Well ID
96-Position
985750



12.5mm Well ID
50-Position
985800



12.5mm Well ID
50-Position
W985810*



15.5mm Well ID
48-Position
868804



17.1mm Well ID
90-Position
868810



23.1mm Well ID
36-Position
868805



28.1mm Well ID
50-Position
868806



30mm Well ID
50-Position
868808

- Manufactured from polypropylene
- Size of rack depends on vial OD
- Easy to clean and autoclavable
- Alphanumeric indexing indicated on rack
- The racks are sturdy and stackable, even when the vials are in place
- Each well has an opening in the bottom to facilitate drainage

When selecting the proper rack, the vial OD can not exceed the well ID dimension.

Cat. No.	Well ID (mm)	Description	No. of Wells	Dimensions (L x W x H)	Qty / Case
Polypropylene Rack					
985750	9.5	96-Position Rack	8 deep x 12 wide	18.5 x 12.5 x 2.2cm	5
985800	12.5	50-Position Rack	5 deep x 10 wide	19 x 10 x 2.2cm	5
W985810*	12.5*	50-Position Rack	5 deep x 10 wide	19 x 10 x 2.2cm	5
868804	15.5	48-Position Rack	4 deep x 12 wide	26.6 x 9.4 x 2.8cm	5
868810	17.1	90-Position Rack	6 deep x 15 wide	33 x 17 x 3cm	5
868805	23.1	36-Position Rack	3 deep x 12 wide	32.2 x 9.1 x 2.8cm	5
868806	28.1	50-Position Rack	5 deep x 10 wide	33 x 17 x 3cm	5
868808	30.0	50-Position Rack	5 deep x 10 wide	33.7 x 17 x 3cm	5

*This rack is specially designed for use with Freestanding CryoELITE® Cryogenic Vials. The vials lock in the rack for one-handed cap removal.

M-T Vial File®



228778



W228792 / 20mL

- Clear plastic hinged case for convenient storage and transportation of sample vials
- Polycoated partitions protect vials from abrasion and breakage
- Alphanumeric index card provides for easy vial identification
- Extra partitions and index cards can be purchased separately

Cat. No.	Description	Max Vial Size Dia. x H (mm)	Qty / Case
228778	Holds 60 – 2mL Vials	12 x 49	6
228780	Holds 40 – 4mL Vials	16 x 49	6
W228790	Holds 54 – 8mL Vials	18 x 64	6
W228792	Holds 24 – 20mL Vials	30 x 64	6

Replacement Partitions and Index Cards for M-T Vial Files®

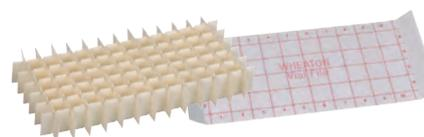

Partition

Index Card

Cat. No.	Description	Qty / Case
W228781	Partitions for Use with 228778	6
W228782	Partitions for Use with 228780	6
W228786	Partitions for Use with W228790	6
W228788	Partitions for Use with W228792	6
228783	Index Cards for Use with 228778	35
228785	Index Cards for Use with 228780	35
W228787	Index Cards for Use with W228790	35
W228789	Index Cards for Use with W228792	35



Information of a More Technical Nature

Technical Data

DWK Life Sciences, with over 120 years of experience, provides quality products and services for the advancement of Science. Being a leading supplier of glass and plastic containers for the laboratory and diagnostics markets, DWK Life Sciences understands the importance of protecting the quality of the most sensitive materials as they may represent one's life's work. We offer containers in a variety of shapes, sizes and materials, meeting the most stringent requirements.

The following pages contain technical information that have been compiled to assist you in selecting and using products from our WHEATON range.

For more information, contact: technical@DWK-LifeSciences.com.

Technical Data

- > Chemical Compatibility Chart.....148
- > Closures127-130
 - Rubber Stopper Formulations129-130
 - Screw Closure Liner Guide128
 - Screw Thread Size127
 - Torque Guide for Screw Closures128
- > Common Conversion Factors147
- > Glass.....131-137
 - Determining a Glass Container Thread Finish134
 - Factors for Selecting Glass Containers.....133
 - General Cleaning of Glassware137
 - Glass Joint Specifications134
 - Glass Manufacturing Terminology.....131
 - Glass Types132
 - Mold Lubricants and Residues135
 - Pressure and Vacuum in Glass Vessels135
 - Recycling Glass Containers137
 - Safety Coated Containers.....136
 - Sterilization of Glass Containers.....135
 - Weathering of Glass Containers.....135
- > Plastic138-144
 - Biological Properties of Plastics141
 - Determining a Plastic Container Thread Finish....141
 - Factors for Selecting Plastic Containers140
 - Plastic Manufacturing Terminology138
 - Plastic Resins139
 - Resin Identification Codes.....144
 - Sterilization of Plastics.....142
 - Typical Properties of Various Plastics139
- > Plug Styles.....145-146



Closure Size & Thread Style Guide

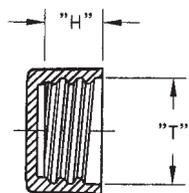

The screw closure industry has not standardized dimensions to the extent that the container industry has, thus it is advantageous to buy both container and screw closure from the same supplier when possible. Similar to the container industry, when a closure finish is designated as 33-400, it means that the nominal diameter measured across the inside of the closure at the opening is approximately 33mm. (See 'T' dimensions on illustration.) The 400 ('H' dimension) designates a specific style of thread. The thread finish of the closure and container must be the same. A container with a 33-400 thread finish should be used with a closure that has a 33-400 thread finish.

Determining Closure Size ('T' Dimension)

To determine closure size, measure the closure opening from one side of the inner wall to the opposite side of the inner wall. Compare this number to the numbers found in the 'T' dimension columns in Table 1. Once this number is found in the table, follow the row to the far left to find the "Nominal Diameter" of the closure (33 in the above example).

Determining Thread Style ('H' Dimension)

To determine the specific thread style, measure the depth of the screw closure from the liner surface to the outside edge of the closure. Compare this number to the numbers found in the 'H' dimension columns in Table 1 that appear in the same row as the Nominal Diameter of the closure. Once this number is found in the table, follow the column to the top to find the specific style number (400 in the above example). The dimensions in the table are approximate and will probably be slightly different from what is measured (especially the 'H' dimension due to variations in liner thickness), but should be close enough to allow for the proper determination of the closure size.

Table 1. Closure Thread Finish Dimensions (Dimensions are in millimeters)

Nominal Dia (mm)	400		410		415		425		430	
	'T'	'H'	'T'	'H'	'T'	'H'	'T'	'H'	'T'	'H'
8	—	—	—	—	—	—	9.14	6.22	—	—
10	—	—	—	—	—	—	10.54	6.48	—	—
13	—	—	—	—	13.21	10.92	13.21	7.11	—	—
15	—	—	—	—	14.86	13.59	14.86	7.11	—	—
18	18.03	9.14	18.03	12.70	18.03	15.11	—	—	18.03	15.37
20	20.07	9.14	20.07	13.46	20.07	18.29	—	—	20.07	15.37
22	22.10	9.14	22.10	14.22	22.10	20.70	—	—	22.10	15.37
24	24.00	9.91	24.00	15.75	24.00	23.75	—	—	24.00	16.51
28	27.81	9.91	27.81	17.40	27.81	26.92	—	—	27.81	18.42
30	28.70	9.91	—	—	—	—	—	—	28.70	19.30
33	32.26	9.91	—	—	—	—	—	—	32.26	19.69
35	34.80	9.91	—	—	—	—	—	—	—	—
38	37.59	9.91	—	—	—	—	—	—	37.59	23.88
40	40.39	9.91	—	—	—	—	—	—	—	—
43	42.16	9.91	—	—	—	—	—	—	—	—
45	44.45	9.91	—	—	—	—	—	—	—	—
48	47.63	9.91	—	—	—	—	—	—	—	—
51	50.16	9.91	—	—	—	—	—	—	—	—
53	52.71	9.91	—	—	—	—	—	—	—	—
58	56.64	9.91	—	—	—	—	—	—	—	—
60	59.69	9.91	—	—	—	—	—	—	—	—
63	62.74	9.91	—	—	—	—	—	—	—	—
66	65.53	9.91	—	—	—	—	—	—	—	—
70	69.72	9.91	—	—	—	—	—	—	—	—
75	74.17	9.91	—	—	—	—	—	—	—	—
77	77.22	11.94	—	—	—	—	—	—	—	—
83	83.19	11.94	—	—	—	—	—	—	—	—
89	89.41	13.08	—	—	—	—	—	—	—	—
100	100.20	14.73	—	—	—	—	—	—	—	—
110	110.23	14.73	—	—	—	—	—	—	—	—
120	120.27	17.14	—	—	—	—	—	—	—	—

Closure Liner Guide

Usually the smallest component part of the package and usually overlooked is the selection of the closure liner. The liner must not alter or be altered by the product. It must withstand repeated applications and removals against the container surface while maintaining the integrity of the sealing surface. Below is information that may help in choosing the right liner from the WHEATON product offering.

Pulp / Poly-Vinyl	One mil poly-vinyl film bonded to one mil HDPE on a #30 white pulp paper backing. Superior to plain pulp paper because it provides an excellent moisture barrier.	General purpose: Suitable for wide range of applications. Chemical resistance: Good for mild acids, alkalis, solvents, alcohols, oils and aqueous products. Poor for active hydrocarbons and bleaches.
PTFE Faced Foamed Polyethylene (PTFE / PE Foam)	PTFE faced foamed polyethylene liner offers the excellent chemical resistance of PTFE with the compressibility and sealing properties of polyethylene foam.	Typical applications: analytical lab samples, high purity chemicals, strong acids, solvents. Excellent for environmental samples, pharmaceuticals and diagnostic reagents.
Polyethylene Cone (PE Cone)	Manufactured from polyethylene (LDPE). The unique cone design provides a wedge type seal that not only seals across the top but also across the inside diameter.	Unique problem solving type of liner. This liner is stress crack resistant and offers superior torque retention and excellent sealing characteristics. It is recommended that this liner be tested prior to use for leak seal.
Styrene-Butadiene Rubber (14B)	The 14B white rubber lining material consists of homogeneous sulfur cured styrene-butadiene rubber. FDA Status complies with 21CFR 177.26, "Rubber articles intended for repeated use."	Excellent properties of resilience, resistant to moisture vapor. Satisfactory for most moderate chemicals. Not good for oils, strong acids and hydrocarbons. Not a natural rubber. Autoclavable.
Styrene-Butadiene Rubber / 0.005 PTFE (PTFE / Styrene-Butadiene)	The white rubber / 0.005" PTFE liner consists of virign PTFE bonded to the white sulfur cured styrene-butadiene rubber. Complies with the FDA 21CFR 177.1550.	Designed for the ultimate in product safety. PTFE provides a totally inert inner seal and surface facing the sample or product. Autoclavable.
Foamed Polyethylene (PE Foam)	A one piece, three ply coextruded liner consisting of both foamed and solid LDPE. The foam core is sandwiched with solid clear PE.	General Purpose: Broad applications base. Chemical resistance-good for acids, alkalis, solvents, alcohols, oils, household cosmetics and aqueous products. Poor for hydrocarbon solvents. Liner provides tight seal.
PTFE Faced Silicone Rubber (PTFE / Silicone)	The liner consists of 0.005" thick PTFE bonded to 0.055" thick silicone rubber.	Ideal for low temperature storage applications. PTFE facing provides excellent chemical barrier. Autoclavable
Pulp / Metal Foil	Aluminum foil bonded to pulp board.	Good barrier properties, good resistance to hydrocarbons, oils, ketones and alcohols. Not good for acids or alkalis.
Low Density Polyethylene (LDPE) Disk	Manufactured from polyethylene.	Good for distilled water, analytical standards and reagents.

Note: Closures and liners are designed for a variety of applications. Product performance can vary depending on conditions. It is recommended that proper tests be performed to determine the best liner for the application.

Torque for Screw Closures

The integrity of the closure-to-container seal is dependent upon a number of variables, such as the materials of the closure, liner, and container, the sealing surface of the container, and the application torque applied to the closure. The most important of these is the application torque. If the closure is applied too loosely, the contents could leak, especially during shipping. If the closure is applied too tightly, it may be too difficult to remove, or the container could break during application.

Table 2 offers some suggested torques that should provide an adequate seal for most applications. It is recommended that proper tests be performed to determine the optimum torque for the application. The most practical way to check the tightness is to measure the removal torque after the closure has been on the container for about 5 minutes. The removal torque should closely approximate the application torque. The minimum removal torque noted in the table should be maintained after a 24 hour period.

Table 2. Suggested Torques for Closures (in-lb)

Closure mm	Phenolic / Urea Closure on Glass Container		Phenolic / Urea Closure on Plastic Container		PP / PE Closure on Glass Container		PP / PE Closure on Plastic Container	
	Application Torque	Min Removal Torque	Application Torque	Min Removal Torque	Application Torque	Min Removal Torque	Application Torque	Min Removal Torque
15	8	4	6	3	12	7	8	4
18	9	5	7	4	13	8	9	5
20	10	5	8	4	15	9	10	5
22	11	6	9	5	17	10	11	5
24	12	6	10	5	18	11	12	6
28	14	7	12	6	21	12	14	7
33	18	9	15	7	24	14	17	8
38	20	10	17	7	29	17	19	9
43	22	11	18	9	33	20	22	11
48	24	12	20	10	36	22	24	12
58	28	14	24	12	44	26	29	14
70	35	18	28	14	52	32	35	17
89	45	22	36	18	65	40	45	22
100	50	25	40	20	75	45	50	25

Although the information in this chart was acquired from reputable sources, it should only be used as a guide in determining the proper application torque. DWK Life Sciences accepts no responsibility for the accuracy of this data or for any consequences resulting from its use.

Rubber Stopper Formulation Descriptions

Listed below are the primary stopper formulations with general descriptions that are supplied by DWK Life Sciences.

Gray Bromobutyl / 39 with Complete Coat A B C

Pros: Low gas and vapor permeability, good for multiple piercing applications, compatible with most cephalosporin's, resistant to animal, vegetable, and mineral oils, good resistance to aliphatic, aromatic and chlorinated solvents

Cons: Not recommended for use with ketones.

Gray Bromobutyl / 46 A B C D

Pros: Low gas and vapor permeability, good for multiple piercing applications, excellent moisture absorption and desorption properties following autoclave and lyophilization drying cycles.

Cons: Poor resistance to mineral oil, aliphatic, aromatic, and chlorinated solvents.

Gray Bromobutyl / 47 A B C D

Pros: Low gas and vapor permeability, great for multiple piercing applications after gamma irradiation, ultra low extractable compound, compatible with most cephalosporin's, very good moisture absorption and desorption properties following autoclave and drying cycles, compatible with WFI applications.

Cons: Poor resistance to mineral oil, aliphatic, aromatic, and chlorinated solvents.

Gray Bromobutyl / 50 B D

Pros: Low gas and vapor permeability, very good properties regarding ozone, animal and vegetable oil.

Cons: Not good for multiple piercing applications, poor resistance to mineral oil, aliphatic, aromatic and chlorinated solvents.

Gray Bromobutyl / 52 B D

Pros: Low gas and vapor permeability, very good properties regarding ozone, animal and vegetable oil.

Cons: Not good for multiple piercing applications, poor resistance to mineral oil, aliphatic, aromatic, and chlorinated solvents.

Gray Chlorobutyl / 46 A B C D

Pros: Low gas and vapor permeability, good for multiple piercing applications, resistant to animal and vegetable oils, good for lyophilization applications.

Cons: Poor resistance to mineral oil, aliphatic, aromatic, and chlorinated solvents.

Gray Chlorobutyl / 49 B D

Pros: Low gas and vapor permeability, resistant to animal and vegetable oils.

Cons: Poor resistance to mineral oil, aliphatic, aromatic, and chlorinated solvents.

Gray Chlorobutyl / 50 B C D

Pros: Low gas and vapor permeability, resistant to animal and vegetable oil, good for lyophilization applications.

Cons: Poor resistance to mineral oil, aliphatic, aromatic, and chlorinated solvents.

Gray Chlorobutyl / 55 B D

Pros: Low gas and vapor permeability, resistant to animal and vegetable oil, good for lyophilization applications.

Cons: Poor resistance to mineral oil, aliphatic, aromatic, and chlorinated solvents.

Gray Chlorobutyl / Isoprene Blend / 40 A B C

Pros: Good coring characteristics, fair resistance to gas and moisture transmission compared to red isoprene.

Cons: Contains dry natural rubber.

Gray Chlorobutyl / Isoprene Blend / 40 with FEP Facing A B

Pros: Barrier properties of FEP, good coring characteristics, fair resistance to gas and moisture transmission compared to red isoprene.

Cons: Contains dry natural rubber.

Gray Chlorobutyl / Isoprene Blend / 50 A B D

Pros: Good coring and reseal characteristics, fair resistance to gas and moisture transmission compared to red isoprene, good for lyophilization applications.

Cons: Contains dry natural rubber.

Black FKM / 55 B

Pros: Low gas and vapor permeability, resistant to animal, vegetable and mineral oil, aliphatic, aromatic, and chlorinated solvents, good for high heat applications.

Cons: Not recommended for ketones.

Pink Natural / 48 B C

Pros: Good coring and very good reseal characteristics.

Cons: Contains dry natural rubber, not good for use with solvents.

Red Natural / 39 B C

Pros: Good reseal characteristics.

Cons: Contains dry natural rubber, not good for use with solvents.



Red Natural / 40 B C

Pros: Good reseal characteristics.

Cons: Contains dry natural rubber. Not good for use with solvents, not appropriate for products that require an inert gas blanket.

Red Natural / 40S B C D

Pros: Good reseal characteristics.

Cons: Contains dry natural rubber. Not good for use with solvents, not appropriate for products that require an inert gas blanket.

Red Natural / 45 B C

Pros: Good reseal characteristics.

Cons: Contains dry natural rubber. Not good for use with solvents, not appropriate for products that require an inert gas blanket.

Red Natural / 45S B C D

Pros: Good reseal characteristics.

Cons: Contains dry natural rubber. Not good for use with solvents, not appropriate for products that require an inert gas blanket.

Natural Silicone / 55 B C

Pros: Good for high heat applications, can withstand multiple steam autoclaves.

Cons: Very poor barrier to gas and vapor transmission, not appropriate for products that require an inert gas blanket.

A Meets the requirements for Type I closures as specified in USP<381> and EP 3.2.9

B Can be steam autoclaved at 121 degrees C

C Can be irradiated at 25 kGy

D Siliconized



Glass Manufacturing Terminology

Annealing Point

The temperature at which internal stresses in glass are significantly reduced. In the annealing operation, glass is gradually cooled from above the annealing point temperature to below the strain point temperature. This slow cooling relieves residual thermal stresses that would develop if the glass were allowed to cool in an uncontrolled manner.

Batch

The mixed raw materials used in manufacturing glass that have been blended and proportionally mixed for delivery to the glass furnace.

Blank

Usually refers to a glass parison that is formed during the first step of glass molding. The piece is then transferred to a lamp worker or glass blower for final shape configuration.

Blister

A gaseous inclusion or bubble in the glass.

Blow Mold

Usually a metal mold used to form a piece of glass from a hot gob.

Borosilicate Glass

A high silicate glass that has at least 5% boron oxide.

Contraction Coefficient

The fractional change in length of a piece of glass per degree change in temperature on cooling from the annealing point to ambient temperature.

Cullet

Waste or broken glass. Clean cullet is always used in the batch.

Density

Mass per unit volume measured in grams per cubic centimeter.

Distribution

The wall thickness or the evenness of the glass distribution throughout the container.

Etch

To attack the glass surface with a strong chemical agent, usually hydrofluoric acid. Usually used in decorating glass.

Finish

The part of a bottle which holds the stopper or closure. The area that has the threads (generally a shortened term for thread finish). The first part made on an automatic machine, but the last part (or finish) to be made when bottles were hand blown. On labware, may refer to an interchangeable ground joint.

Forming

The shaping of hot glass.

Glassblowing

The shaping of glass using air pressure.

Gob

A portion of hot glass that is delivered from the furnace for forming.

Hard Glass

A glass with a high softening point or high viscosity (usually borosilicate).

Hot End

A manufacturing term for the area of a glass manufacturing plant where molten glass is processed.

Lampworking

Flame re-working of a blank or tubing cane, typically on a lathe.

Lehr

A long belt-fed, tunnel-shaped oven used to heat glass to the annealing point and then slowly cool it to room temperature to remove any residual thermal stresses in the glass. Can also be a large oven where glass is manually loaded and unloaded (batch lehr).

Linear Coefficient of Expansion

The fractional change in length of a piece of glass per degree change in temperature. The coefficient of expansion generally indicates the thermal endurance of the glass. Glasses with a low linear coefficient of expansion can be subjected to greater rapid temperature changes with less chance of fracture than glasses with a high coefficient of expansion. (Generally, Type I glass has a lower COE than Type III).

Melt

The amount of glass that is melted at one time.

Mold Mark

The mark in the bottom of the container that denotes the manufacturer.

Pressed Glass

Glassware that is formed by pressing a gob between a mold and a plunger.

Soda-Lime (or Soft) Glass

A glass with a substantial portion of lime in the formula.

Softening Point

Temperature at which a thread or rod of glass rapidly deforms under its own weight.

Strain Point

The temperature at which thermal residual stresses become permanent upon cooling. Temperatures above the strain point will introduce permanent stresses that can cause or contribute to fracture. At temperatures below the strain point, the glass can be temporarily heated and cooled without introducing permanent stress. The strain point can be considered the maximum service temperature.

Tank

The furnace that melts the raw materials into molten glass. Temperatures in the tank vary depending on the glass type being melted, but are typically in excess of 1200°C.

Temper

The degree of residual stress in annealed glass as measured using polarized light techniques.

Weathering

The attack on glass surface by atmospheric elements.

WHEATON Glass Types

The glass products in this catalog are made from many different glass formulations. Following are brief definitions of these glass types and descriptions of their characteristics.

- 180 Glass:** An exceptionally clear borosilicate glass of high chemical durability, which has been especially formulated for the lowest background count. Great care has been taken to select only those ingredients for the batch that would not cause unwanted background count or color. Potassium as a separate element has been excluded from the batch to minimize K40. Special controls assure high quality and batch-to-batch uniformity. This glass type is used in the manufacture of specialty tubing containers.
- 200 Glass:** Also referred to as 33 expansion low extractable borosilicate glass, is a clear borosilicate glass with exceptional thermal endurance that meets the requirements for ASTM Type I, Class A. This glass also meets USP Type I Glass Grains, USP Arsenic, EP Type I Glass Grains (Test B), and EP Arsenic, as specified in the current revisions of the U.S. Pharmacopeia and European Pharmacopeia. This glass type is used in the manufacture of tubing containers and laboratory glassware. Some containers may also be tested for compliance to the current USP Type I Surface Test and EP Type I Surface Test (Test A). Compliance to these tests will be noted on the certificate of compliance for that item.
- 300 Glass:** A chemically resistant clear borosilicate glass that meets the requirements for ASTM Type I, Class B. This glass also meets USP Type I Glass Grains, USP Arsenic, EP Type I Glass Grains (Test B), and EP Arsenic, as specified in the current revisions of the U.S. Pharmacopeia and European Pharmacopeia. This glass type is used in the manufacture of tubing containers. Some containers may also be tested for compliance to the current USP Type I Surface Test and EP Type I Surface Test (Test A). Compliance to these tests will be noted on the certificate of compliance for that item.
- 320 Glass:** A similar composition to 300 Glass except amber color for light sensitive applications. Meets UV light protection limits as specified in the current revisions of the U.S. Pharmacopeia and European Pharmacopeia.
- 400 Glass:** A clear borosilicate glass that falls well within the limits for USP Type I Glass Grains, USP Arsenic, EP Type I Glass Grains (Test B), and EP Arsenic, as specified in the current revisions of the U.S. Pharmacopeia and European Pharmacopeia. This glass type is used in the manufacture of molded bottles. Some containers may also be tested for compliance to the current USP Type I Surface Test and EP Type I Surface Test (Test A). Compliance to these tests will be noted on the certificate of compliance for that item.
- 500 Glass:** Similar to the 400 Glass formulations except amber color for light sensitive applications. Meets UV light protection limits as specified in the current revisions of the U.S. Pharmacopeia and European Pharmacopeia.
- 800 Glass:** A superior soda-lime clear glass that meets the requirements for USP Type III Glass Grains, USP Arsenic, EP Type III Glass Grains (Test B), and EP Arsenic, as specified in the current revisions of the U.S. Pharmacopeia and European Pharmacopeia. This glass type is used in the manufacture of molded bottles. Some containers may also be tested for compliance to the current USP Type III Surface Test and EP Type III Surface Test (Test A). Compliance to these tests will be noted on the certificate of compliance for that item.
- 900 Glass:** Similar in formulation to 800 Glass except amber color for light sensitive applications. Meets UV light protection limits as specified in the current revisions of the U.S. Pharmacopeia and European Pharmacopeia.

Table 3. Typical Properties of WHEATON Glass

	Glass Type							
	Borosilicate						Soda-Lime	
	"180" Tubing Vial Clear	"200" Tubing Vial Clear	"300" Tubing Vial Clear	"320" Tubing Vial Amber	"400" Molded Container Clear	"500" Molded Container Amber	"800" Molded Container Clear	"900" Molded Container Amber
Strain Point °C	510	505	525	510	530	515	510	496
Annealing Point °C	560	560	570	560	570	550	548	536
Softening Point °C	820	820	785	770	750	745	729	713
Linear Coefficient of Expansion (0-300°C) x 10 ⁻⁷	33	33	55	54	60	61	88	91
Density g/cm ³	2.23	2.23	2.33	2.39	2.41	2.42	2.48	2.50
ASTM E-438 Glass Type & Class	I A	I A	I B	— —	— —	— —	— —	— —
USP Powdered Glass <660>	Type I	Type I	Type I	Type I	Type I	Type I	Type III	Type III
USP Light Transmission <671>	—	—	—	Yes	—	Yes	—	Yes
USP Arsenic <211>	Yes	Yes	Yes	Yes	Yes	Yes	Yes	Yes
EP Glass Grains (Test B) 3.2.1	Type I	Type I	Type I	Type I	Type I	Type I	Type III	Type III
EP Spectral Transmission 3.2.1	—	—	—	Yes	—	Yes	—	Yes
EP Arsenic 3.2.1	Yes	Yes	Yes	Yes	Yes	Yes	Yes	Yes

ASTM= American Society for Testing and Materials USP= U.S. Pharmacopeia EP= European Pharmacopeia

Factors for Selecting a Glass Container

Chemical Durability

The U.S. Pharmacopeia classifies pharmaceutical glass containers according to their chemical durability, which is their resistance to water attack. Different types of glass react differently when exposed to solutions and vapors. Reactive substances will leach constituents from the glass surface into the contained product. This reaction can occur with ordinary aqueous, saline and alcohol based solutions. The primary ion removed from the glass surface is sodium; however all elements are subject to leaching. It is not uncommon to experience an increase in product pH as sodium is extracted from the container. Corrosion of the glass occurs over time and is accelerated by moist heat-treating processes like autoclaving.

Containers are classified by the USP as Type I, Type II and Type III. Type I is the most chemically durable glass and Type III is the least durable. Test methods and specification limits are determined by the USP in Chapter <660> Containers. USP Type can be used as a general guide for container selection but should not be the only criteria in the decision making process. A set of criteria has been developed over the years to assist with the selection of glass containers. These guidelines were established to narrow the selection of possible containers. It is the product manufacturers responsibility to do testing to ensure that the glass container is suitable for the application and contained product.



USP Type I

USP Type I classification is a borosilicate glass with superior chemical resistance. This class of glass represents the least reactive glass containers available. Typically, this glass can be used for most applications, including packaging for parenteral and non-parenteral products. Type I glass may be used to package acidic, neutral and alkaline products. Water for injection, unbuffered products, chemicals, sensitive lab samples and those requiring sterilization are commonly packaged in Type I borosilicate glass. Type I glass can be subject to chemical attack under certain conditions, thus container selection must be made carefully for very low and very high pH applications. Most glass laboratory apparatus are Type I borosilicate glass.

Even though Type I glass has the highest chemical durability, there still may be some sensitivity with certain packaged products. For applications where standard Type I glass does not provide sufficient protection against alkali extraction and pH shifting, internal surface treatment can be used to further improve the chemical durability of the container. This surface enhancement may become especially important for pH sensitive products packaged in small containers because smaller containers have a higher surface area to volume ratio. See the USP Type II description for an explanation of the internal surface treatment process. It should be noted that the USP does not place any additional durability requirements on surface treated Type I glass.

USP Type II

USP Type II glass is soda-lime glass that has been treated with sulfur compounds to de-alkalize the interior surface of the container. This treatment results in a container with high chemical resistance because alkali is removed from the glass surface prior to use. The amount of ions available to leach into the product is reduced, thus the container durability is increased. Extraction salts will be present on the interior surface of new sulfur treated containers, and the containers may require washing prior to use. Type II glass is less chemically durable than Type I glass, but is more chemically durable than Type III glass. It can be used for acidic and neutral parenteral preparations that remain below pH 7 during their shelf life.



USP Type III

USP Type III is a soda-lime glass with moderate chemical resistance. It is typically acceptable for packaging dry powders that will be dissolved into solutions or buffers that are insensitive to alkali.

Type III glass may not be suitable for autoclaved products because the autoclaving process will accelerate the glass corrosion reaction. Dry heat sterilization processes are typically not a problem for Type III containers.

Factors other than USP Type

Handling Considerations

It is important to consider filling and processing steps when choosing a container. Both mechanical and thermal stresses are important factors. For a given thermal expansion range, a typical tubing vial with thin, uniform walls will withstand thermal shock better than a molded glass container.

The physical design of the container will play a part in the amount of thermal and mechanical shock resistance it exhibits. It is often necessary to make a compromise between high resistance to mechanical shock and high resistance to thermal shock.

Light Sensitivity

Light sensitive products must be packaged in amber glass. Amber glass is formulated to absorb light in the Ultra Violet region of the electromagnetic spectrum. Test methods and specification limits for light protection can be found in the U. S. Pharmacopoeia.

Specific Ion Sensitivity

If a product is sensitive to the presence of particular ions, the composition of the glass container should be considered. For example, products that contain sulfate salts may experience the formation of precipitates if packaged in glass with barium or calcium in the formulation. In this example, it would be desirable to avoid glass that contains barium and calcium. A second example is pre-cleaned containers for environmental sampling. Even though the containers are clean, the chemical durability characteristics of the glass have not been altered. Thus, it would not be feasible to test the samples for low levels of sodium, because the sample will extract sodium from the container's surface.

Determining a Glass Container Thread Finish

GPI refers to the Glass Packaging Institute, which is responsible for establishing and issuing uniform voluntary standards regarding the types and finishes produced by American glass manufacturers. When a container finish is designated as 20-400, it means that the diameter across the outside of the threads is approximately 20mm. (See 'T' dimension on illustration.) The 400 designates a specific style of thread. Table 4 shows average dimensions for comparison and to aid in sizing. The actual dimensions may vary slightly, but should be close enough for proper determination of thread finish.

Other Variables to Consider

1. Container size and physical design. Narrow mouth vs. wide mouth, tall vs. short, etc.
2. Color. Is light sensitivity an issue? Is amber glass needed?
3. Shelf life. How long are you planning to store a sample or product in the container?
4. Method of fabrication. Molded or tubing based?
5. Processes the container will undergo. Storage conditions (freezing or heat); washing, sterilization; method of sealing; humidity; hot or cold filling; de-pyrogenation.

6. Storage after filling. Time (shelf life needed); heat, cold, moisture; shipping conditions; light exposure.
7. Product composition. Dry powder; pH; concentration of ions; physico-chemical properties.
8. Closure type. Wide mouth vs. narrow mouth; septa lined open top closure; closed closure; liner material; sealing needed; threaded closure or crimp seal.

Opening Dimension of Glass Containers with Thread Finish

The minimum opening dimension 'I' of a glass container can be found if the containers thread finish is known. If the thread size of the container is 38-400, the 'I' can be determined from Table 4 by looking down the 'T' Dimension column (far left) until you find the number 38. Follow this row to the right, until you come to the 'I' min. column that is listed under the number 400. This number is the minimum opening of the container. The opening can be larger, but it should not be smaller.

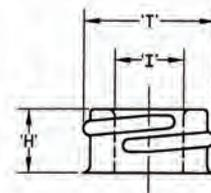

Table 4. Glass Thread Finish Dimensions (Dimensions are in millimeters)

'T' Dim (mm)	400		410		415		425		430	
	'H'	'I' min	'H'	'I' min	'H'	'I' min	'H'	'I' min	'H'	'I' min
8	—	—	—	—	—	—	6.53	2.90	—	—
10	—	—	—	—	—	—	6.86	3.76	—	—
13	—	—	—	—	11.23	5.54	7.49	5.54	—	—
15	—	—	—	—	13.89	6.55	7.49	6.55	—	—
18	9.04	8.26	13.03	8.26	15.42	8.26	—	—	15.34	6.86
20	9.04	10.26	13.82	10.26	18.59	10.26	—	—	15.34	7.92
22	9.04	12.27	14.61	12.27	21.01	12.27	—	—	15.34	10.41
24	9.78	13.11	16.15	13.11	24.05	13.11	—	—	16.43	11.68
28	9.78	16.26	17.73	16.26	27.23	16.26	—	—	18.39	13.34
30	9.86	16.59	—	—	—	—	—	—	19.30	14.43
33	9.86	20.09	—	—	—	—	—	—	19.69	17.86
35	9.86	22.23	—	—	—	—	—	—	—	—
38	9.86	25.07	—	—	—	—	—	—	24.03	21.03
40	9.86	27.71	—	—	—	—	—	—	—	—
43	9.86	29.59	—	—	—	—	—	—	—	—
45	9.86	31.78	—	—	—	—	—	—	—	—
48	9.86	35.08	—	—	—	—	—	—	—	—
51	9.98	37.57	—	—	—	—	—	—	—	—
53	9.98	40.08	—	—	—	—	—	—	—	—
58	9.98	44.07	—	—	—	—	—	—	—	—
60	9.98	47.07	—	—	—	—	—	—	—	—
63	9.98	50.09	—	—	—	—	—	—	—	—
66	9.98	53.09	—	—	—	—	—	—	—	—
70	9.98	57.07	—	—	—	—	—	—	—	—
75	9.98	61.57	—	—	—	—	—	—	—	—
77	11.99	64.67	—	—	—	—	—	—	—	—
83	11.99	69.93	—	—	—	—	—	—	—	—
89	13.21	74.12	—	—	—	—	—	—	—	—
100	14.78	84.94	—	—	—	—	—	—	—	—
110	14.78	94.92	—	—	—	—	—	—	—	—
120	17.02	104.93	—	—	—	—	—	—	—	—

Glass Joint Specifications

§ Symbol used to indicate interchangeable joint, stoppers and stopcocks that comply with the requirements of ASTM E676 (taken from commercial standard CS21).

§ Symbol used to indicate a spherical joint that complies with the requirements of ASTM E677 (taken from commercial standard CS21-58).

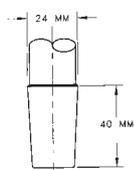

§ 24/40 Inner Joint

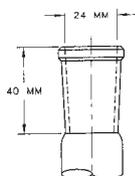

§ 24/40 Outer Joint



§ 35/25 Ball Joint

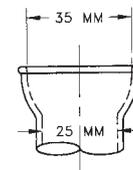

§ 35/25 Socket Joint

Sterilization of Glass Containers

Although most types of glass is sterilizable by either steam or dry heat certain techniques are recommended for specific types of glass. Most Type I borosilicate glass is suitable, when proper techniques are followed, for sterilization and de-pyrogenation. Type III is not recommended for repeated steam sterilization, although this may be appropriate on a single use basis. Recommended autoclave cycles are 121°C @ 15 psi for 20 minutes. Closures should be left loose on the containers. Proper care must be given when venting back to atmosphere or there may be damage to the containers.

Dry heat sterilization can be achieved at a temperature of 160°C for 2 to 3 hours, but glass containers are capable of withstanding sterilization temperatures up to 500°C without noticeable degradation of the glass. Repeated dry heat sterilization of containers containing a fair amount of moisture may be susceptible to glass flaking. Inversion of the container and good ventilation would prevent this from occurring. Inspect glass containers for chips, cracks and scratches before each use and discard if damage is evident, as breakage may occur during sterilization if used. Glass containers may also be sterilized using gas or chemicals. Ethylene oxide (EtO), formaldehyde or peroxide gas is generally used when heat and pressure cannot be used due to material limitations. Chemical disinfectants normally used are quaternary ammonium compounds, iodophors, formalin, benzalkonium chloride and ethanol.

Glass containers may also be sterilized using irradiation, however, the process changes the color of the glass, which may not be acceptable for most applications. There is glass tubing available that will not change color when irradiated. This would be available for those interested in large quantity orders of tubing vials only.

Mold Lubricants and Residues

Modern high-speed mold production of glass containers requires the use of release agents or coatings on the metal mold equipment to prevent sticking and malformation of the bottles in the molding process. A variety of coatings or lubricants are used to provide optimum viscosity and function according to the particular needs of the individual piece of process equipment as well as service conditions.

The coatings are compounded from colloidal graphite and sulfur suspended in hydrocarbon oils and waxes with small amounts of modifiers such as calcium soaps and greases. This "mold dope" is replenished through periodic swabbing of the mold equipment. The hot forming temperature and the subsequent lehr annealing (1000 – 1100°F) process will burn off the volatile sulfur and organic oils and waxes. Portions of carbon can remain since the major component (graphite) is very slowly decomposed and oxidized in the process. Quality control in manufacturing employs a number of devices (both automatic and manual) to eliminate the small percentage of product that has excess graphite spots.

Pressure and Vacuum in Glass Vessels

Because the conditions under which glassware is used vary widely, there is no guarantee against breakage. Always exercise care to protect personnel and property when using any vessel with vacuum or pressure. Never subject glassware showing visible signs of damage (chipped, cracked or scratched) to pressure or vacuum.

Weathering of Glass Containers

When glass containers are formed, the surface of the glass is enriched in alkali. The annealing process further enhances this effect. This phenomena is usually of no practical consequence and goes unnoticed, but in certain circumstances, it interferes with further processing of the container. As glass is exposed to the atmosphere, a complex reaction occurs on the surface between the alkali on the glass and gasses in the air. These reactions are commonly known as weathering. The reaction produces salts, which can absorb water from the air. It is these salts that are the

source of surface related decorating problems. Weathering salts are composed of a mixture of various hydrates of sodium carbonate and sulfate along with minor amounts of similar calcium salts. Weathering is a normal condition and such salts are always found on glass surfaces as they are exposed to the atmosphere. The quantity and crystal appearance will vary depending upon time, humidity and temperatures of storage. These salts are easily removed by water rinsing.

All glass weathers, but some are more resistant than others. Borosilicate glass is most resistant, followed by durable soda-lime, and common soda lime. Since glass containers can be decorated in a myriad of ways, the weathering of glass must be considered in selecting a method that is effective and trouble free. Below is a weathering chart to be used as a rough guide to decorating and labeling of glass.

The surface treatments used to remove weather salts or remove the alkali that cause weathering are somewhat limited. Since the salts are water soluble, a simple wipe with a wet cloth or washing prior to decoration or pressure sensitive labeling is effective in most cases.

Heat and humidity cycling or storing glass in a confined space promotes weathering. Keeping the glass under constant low humidity is effective in slowing weathering as it keeps the surface dry and reduces the salt build-up. Dry heating the container just prior to decorating or pressure sensitive labeling is sometimes successful.

A layer of absorbed moisture on the glass prevents good adhesion of pressure sensitive labels. Water based adhesives, however, would be no problem. Several possible solutions to the problem can be suggested:

1. Simply storing the containers in an area of low humidity for several days may solve the problem.
2. Washing or wiping the ware with warm water. This removes the weathering salts and allows the achievement of a moisture-free surface.
3. Heating the ware will dry the surface and allow good adhesion of the labels. Heating will not remove the salts so the heating must be accomplished shortly before labeling.

The presence of dry salts on the ware will not cause a problem, but the salts can again, rapidly absorb moisture.

Weathering Chart

Rate of Weathering	Very slow (months)	Slow under low humidity Rapid under high humidity (typically weeks)
Pressure Sensitive Labels	√	√ Success varies with amount of weathering
Glue Labels	√	√
Ceramic Screen	√	√
Organic Screen	√	√
Gold	√	√ If not severely weathered

(√ = O.K.)



Safety Coated Containers

A plastisol coating was developed to contain glass fragments and allow for a controlled release of the contents in the event of container breakage. The coating:

- Adds impact, thermal shock and slip resistance
- Contains glass - prevents flying fragments and cuts
- Contains contents - reduces risk of chemical exposure and inhalation. Allows time for proper disposal.

The coating material is plastisol, which is a dispersion of a fine particle size PVC resin (polyvinyl chloride) in a plasticizer where stabilizers, fillers, modifiers, colorants and other compounding ingredients may be added. When the plastisol is heated, the suspended PVC particles begin to swell and absorb the surrounding liquid plasticizer. When the temperature is increased to over 300°F, fusion of the particles occurs and the particles coalesce into a homogeneous mass. The coating process is a heat-and-time related process that determines coating weight and thickness and is controlled by machine line speeds and oven temperatures. The more heat, the heavier the coating, and the slower the line, the heavier the coating.

Non-autoclavable coated containers can be used successfully at 121°C (250°F) and below. Do not use above 300°F or over direct heat or flame. The coating is not dry heat sterilizable. Coating will yellow and burn with high heat exposure but will continue to protect until black.

Labeling Adhesives for Coated Glass Containers

Labeling of plastisol coated glass containers has always been somewhat of a problem. It is important to select a face stock and adhesive combination with the proper performance characteristics for the intended product and application. It is recommended that prior to the selection of any adhesive, the customer contact the adhesive manufacturer or supplier and discuss the application requirements.

For on-line and pressure sensitive labeling of plastisol coated glassware, an acrylic based adhesive with low rubber and vinyl content is recommended. Other label adhesives will usually extract the plasticizer from the coating, become soft, bleed through the label and eventually lose adhesion. Acrylics block the plasticizer extraction and allow the initial adhesion to remain undisturbed. There are, however, many variations of acrylic based adhesives and some are more effective than others. Adhesives are usually formulations of several chemicals that are combined in a variety of ratios and available in many forms. It is for these reasons, that accelerated age testing is advisable.

When selecting an adhesive for a specific application, consideration should be given to the necessary bond strength and duration, moisture, UV, heat and solvent resistance. There is no substitute for proper testing of the proposed materials under actual usage conditions. The final decision should be made by the customer to choose the label / adhesive combination that meets the requirements of the specific use.

Autoclave Sterilization

Recommendations for Autoclavable Coated Containers

The suggested conditions for steam sterilization are 121°C (250°F) @ 15 psi for 20 minutes. Portions of the coating may absorb a small amount of water vapor and appear cloudy after autoclaving, however, the cloudiness will disappear as the coating dries. To speed clearing, glassware can be dried in an oven at 49 – 66°C (120 – 150°F). Autoclaving effects on the coating will vary slightly due to equipment, container size and configuration, procedure and frequency of procedure. It is recommended that containers not be autoclaved touching each other to avoid possible sticking problems. Also, it is recommended that the autoclave pressure be allowed to return to zero before removing glassware. A sudden release of pressure may cause the coating to separate from the glass and produce air pockets under the coating.

Evaluation of a sample is the best way to determine if the safety coating will work for your application.

Recycling Safety Coated Containers

For after-use disposal, PVC safety coated containers create a unique situation in that they are a composite package of glass and plastic. Depending on the application, there are four ways to handle the disposal of coated containers:

Reuse

In the laboratory or industrial setting, coated containers can be washed, dried and reused, perhaps for the collection of hazardous waste in the laboratory.

Recycle

For consumer pharmaceutical and cosmetic applications, coated glass containers should be able to go into residential glass recycling collection. Coated glass makes up such a small percentage of total glass collected that it should not present any recycling problems (variations in state and county recycling programs make it difficult to generalize).

For large quantity industrial or laboratory applications, recycling coated glass containers, as a whole, can create two problems: the grinding of the coated glass into cullet could be difficult, and the PVC in the glass furnace might create organic chlorides in the glass mixture that would affect the final pH of the glass. Also, if a hazardous material was packaged in the containers, many recyclers do not want to accept the glass.

The plastic coating can be cut and peeled from the container and the glass and the plastic jacket recycled, but for safety reasons this is not recommended. Both glass and PVC are recyclable materials. Stripped coatings are recycled into garden hoses and floor mats.



Recycling Safety Coated Containers (Cont.)

Landfill

Coated containers can be crushed and safely landfilled. The plastic jacket is made of PVC material, which is very chemically stable and does not leach out harmful chemicals into groundwater. In fact, PVC is often used to make liners for landfill sites.

Incinerate

Coated containers can be incinerated. PVC is often blamed for the release of toxic dioxins and hydrochloric acid (HCL). However, research has shown that dioxins and hydrochloric acid are generated no matter what amount of PVC is present in the waste. Incinerator operating conditions and temperatures determine the amounts produced. Hydrochloric acid, which can cause acid rain, can be controlled in a modern incinerator equipped with a proper scrubber.

The safety coating was developed to contain the glass fragments and allow for a controlled release of the contents in the event of container breakage. In addition, the coating adds impact, thermal shock and slip resistance, prevents flying fragments and cuts and reduces risk of chemical exposure and inhalation. Few, if any, alternative-coating materials have been found that perform as well or better than PVC plastisol.

Recycling Glass

Most household glass containers are manufactured from soda-lime glass. All of our soda-lime glass may be recycled in the same manner after performing any necessary decontamination procedures. Borosilicate glass must not be mixed and recycled with soda-lime glass.

General Cleaning of Glassware

Handle glassware carefully. Most damage to glassware occurs during cleaning. Glassware should be washed as soon as possible after use to avoid caking of residue. It is important not to let soiled glassware dry out. If immediate cleaning is not possible, the glassware should be put to soak in water. Use of a cleaning agent is recommended. Glassware should not be cleaned with harsh or abrasive cleaners. It is recommended that a mild detergent or non-abrasive cleaner be used. Hard utensils, wire brushes or bottle brushes with wire cores, should not be used for cleaning. It is recommended that a sponge brush that is soft and flexible be used. Scratched glassware is prone to breakage during freezing or heating.

After washing, the glassware should be rinsed with tap water to remove any cleaning agent residue. After the tap water rinse, the glassware should be rinsed with distilled or deionized water. Dry the glassware inverted on racks or pegboards. Inspect the glassware for chips, cracks and scratches on the inside and outside. Do not use glassware with visible signs of damage.

Plastic Manufacturing Terminology

Blow Mold

Cavity that receives the Preform, which will be blown into the desired shape.

Blow Pin

Used in Extrusion Blow Molding. Hollow tube that pierces Preform and introduces air to blow Preform into shape of Blow Mold.

Cavity

That part of the mold that contains the reverse image of the product being formed.

Cold Runner

Flow channel for heat-softened polymer that goes from the Plastifier to the mold cavities. Polymer in the flow channel is cooled with shaped parts in cavities and is later removed, reground, and reused.

Core

That part of a mold that allows the internal shaping of a product such as the internal threads of a closure.

Core Rod

Used in Injection Blow and Injection Stretch Blow Molding. Used in conjunction with a Preform Mold to manufacture a Preform. The Preform is formed around the Core Rod creating a hollow tube, which will then be transferred to a Blow Mold where air will be introduced forcing the Preform to take the shape of the Blow Mold cavity.

Extrusion Blow Molding

A molding process whereby heat-softened polymer is forced into the shape of a hollow tube. While still soft, a mold closes around the tube, pinching the top and bottom of the tube closed. A Blow Pin is introduced, and air is forced through the pin forcing the tube to take the shape of the Blow Mold cavity.

Flame Treating

A method of rendering inert thermoplastic objects receptive to inks, lacquers, paints, adhesives, etc. in which the object is bathed in an open flame to promote oxidation of the surface of the article. Polyolefins (HDPE, LDPE, PP, etc) are primarily those polymers that are flame treated.

Flash

Extra plastic attached to molded ware along the parting line, which must be removed before the part can be considered finished.

Gate

Used in Injection, Injection Blow and Injection Stretch Blow Molding. The orifice through which the heat-softened polymer enters the cavity.

Hot Runner

Flow channel for heat-softened polymer, which goes from the Plastifier to the mold cavities. Polymer in the flow channel is kept softened so there is no runner material to grind up and reuse.

Hopper

Conical feed reservoir into which polymer pellets are loaded. These pellets then fall into a heated barrel (Plastifier), sometimes through a metering device.

Injection Blow Molding

A molding process in which heat-softened polymer is injected from a Plastifier into a mold cavity creating a Preform, which is then transferred to a Blow Mold where air is blown into the Preform, forcing it to take the shape of the Blow Mold cavity.

Injection Molding

A molding process whereby a heat-softened polymer is injected from a Plastifier into a relatively cool cavity, which gives the article the desired shape.

Injection Stretch Blow Molding

A molding process whereby Preforms are introduced into a cavity, stretched axially by a Stretch Rod, and then blown circumferentially to the shape of the Blow Mold cavity.

Melt Index

The amount, in grams, of a thermoplastic resin, which can be forced through a 0.0825 inch orifice when subjected to 2160 gms. force in 10 minutes at 190°C.

Mold

Contains the cavity or cavities of a desired part in which a heat-softened polymer is shaped.

Mold Seam

A line formed at the point of contact of the Mold halves.

Neck Ring

Part of the mold assembly that forms the neck and finish of a container.

Nozzle

Hollow cored orifice that is screwed into the extrusion end of the Plastifier. The nozzle is designed to form a seal under pressure between the Plastifier and the Mold or Runner system. The front end of a nozzle may be either flat or spherical in shape.

Plastifier

Assembly whereby polymer pellets are fed from a Hopper into a barrel where they drop onto a turning screw which forces the pellets forward. Heater bands wrapped around the barrel melt the pellets as they are forced forward along the inside of the barrel. The molten polymer is then forced out the end of the barrel through the nozzle.

Preform

Used in Blow Molding processes. Heat-softened polymer is formed into a shape similar to a thick test tube with neck threads. This tube is subsequently inflated while inside a Blow Mold to create the shape of the desired article.

Regrind

A thermoplastic from a processor's own production that has been reground or re-pelletized after having been previously processed by molding.

Release Agent

A lubricant that facilitates molding.

Stretch Rod

Used in Injection Stretch Blow Molding. A rod that is introduced into the Preform to stretch it in an axial direction prior to the Preform being blown into the shape of the cavity.

Swingplate Injection Molding

A molding process where a heat softened polymer is injected through a stationary plate and then through a second metal plate or "swingplate", through cores mounted on the other side of the swingplate, and into cavities in a third plate. The polymer flows out of and around the cores and fills the cavities. Once the cavities are filled, the third plate moves away from the cores, leaving the molded parts on the cores. The swingplate then swings over to a secondary station where the cold runner and molded parts are removed. While this is happening, another swingplate moves from the secondary station to the first station and new parts are molded.

Thermoplastic

Material that will repeatedly soften when heated and harden when cooled.

Plastic Resins

Listed below are the primary resins used in the manufacture of our products. Following are some of the characteristics and features of these resins. Also listed is the Society of the Plastic Industry (SPI) resin identification code number.

High Density Polyethylene (HDPE)

Flexible but more rigid than LDPE. Natural color is milky white, semi-translucent depending on density. Good impact strength and stress crack resistance. Good chemical resistance. Good vapor barrier but poor gas barrier. Sterilizable via EtO or gamma radiation.



Low Density Polyethylene (LDPE)

Very flexible, natural milky color, translucent with high impact strength. Excellent for mild and strong buffers, good chemical resistance. Good water vapor and alcohol barrier properties. Poor gas barrier, sterilizable with EtO or gamma radiation. Good stress crack and impact resistance.



Linear Low Density Polyethylene (LLDPE)

Very flexible, natural milky color, translucent with high impact strength. Excellent for mild and strong buffers, good chemical resistance. Good water vapor and alcohol barrier properties. Poor gas barrier, sterilizable with EtO or gamma radiation. Good stress crack and impact resistance.



Polybutylene Terephthalate (PBT)

Good chemical resistance, clear color, resistant to water, weak acids and bases at room temperature. Can be sterilized by EtO and autoclaving, at temperatures up to 180°C.



Polycarbonate (PC)

Rigid and strong, excellent clarity. High impact strength. Poor barrier properties.



Polyethylene Terephthalate (PET)

Semi-rigid to rigid depending on wall thickness. Natural color — clear and transparent. Good alcohol and solvent barrier; good gas and fair moisture barrier. Good to fair chemical barrier; not good for strong acids or bases. Good moldability. Sterilizable through EtO and gamma radiation. Good stress crack and impact resistance at room temperature and above.



Polyethylene Terephthalate Glycol (PETG)

Semi-rigid to rigid depending on wall thickness. Natural color — clear and transparent. Good alcohol and solvent barrier; fair gas and good moisture barrier. Good to fair chemical barrier; not good for strong acids or bases. Good moldability. Sterilizable through EtO and gamma radiation. Good stress crack and impact resistance at room temperature and above.



Polypropylene (PP)

Rigid, solid, durable in container or closure forms. Opaque, natural grayish yellow in natural form. Excellent stress crack and impact resistance. Excellent moisture barrier, good oil and alcohol barrier, poor gas barrier properties. Good chemical resistance. Sterilizable with EtO or autoclaving.



Polystyrene (PS)

PS is a transparent, rigid and glass-like polymer. Good resistance to inorganic chemicals. Light and heat stable, biologically inert and non-toxic. Poor impact and stress crack resistance, poor barrier properties. EtO or Gamma sterilizable.



Polyvinyl Chloride (PVC)

Flexible to rigid. Good for coatings; fair water and good oxygen barrier. Transparent to yellowish color in natural state. Good chemical resistance. Sterilizable by EtO. Good impact and some stress crack resistance. Poor recycling due to chloride residues.



PTFE, FEP, PFA

Polytetrafluoroethylene, fluorinated ethylene propylene, perfluoroalkoxy. All fluoropolymers feature opaque characteristics, excellent chemical resistance, good heat stability and thermal shock resistance. All are autoclavable, heat, and gas sterilizable.



Table 5. Typical Properties of Plastics

	HDPE	LDPE	LLDPE	PC	PET	PETG	PP	PS	PVC	PTFE
Max. Temp °C	120	80	50	135	60	70	135	70	70	240
Transparency	Transl	Transl	Transl	Transp	Transp	Transp	Transl	Transp	Transl	Opaq
Sterilization**										
Autoclave	No	No	No	Yes	No	No	Yes	No	No	Yes
Gas	Yes	Yes	Yes	Yes	Yes	Yes	Yes	Yes	Yes	Yes
Dry Heat	No	No	No	No	No	No	No	No	No	Yes
Radiation	Yes	Yes	Yes	Yes	Yes	Yes	No	Yes	No	No
Disinfectants	Yes	Yes	Yes	Yes	Yes	Yes	Yes	No	Yes	Yes
Density G/Cm ³	0.95	0.92	0.92	1.19	1.33	1.27	0.90	1.06	1.34	2.15
Flexibility	Semi	Flex	Flex	Rigid	Semi	Semi	Rigid	Rigid	Rigid	Rigid
Brittleness Temp °C	<-75	<-75	-76	-135	-10	-40	0	+20	-30	-110
Tensile Strength, Psi	4000	2400	2000	9000	8000	7500	5000	6000	5000	4000

**Depends on thickness and relates to containers and closures. Because there are many grades of resins and processing methods, the above information should be used as a general guideline only.

Table 6. Permeability of Plastics

	HDPE	LDPE	LLDPE	PC	PET	PETG	PP	PS	PVC	PTFE	
N ₂	See Note 1	42	180	—	50	0.8	10	44	50	2	—
O ₂	See Note 1	150	500	—	250	5	25	90-140	185-485	4	—
CO ₂	See Note 1	580	2700	—	1000	15	125	650	1160	4	—
Moisture	See Note 2	0.3	1.3	—	7.4	2.0-4.0	0.5	0.3-0.7	8.5	1.0-5.0	—

Note 1: Units are cc x mil / 100 in² x day x atm @ 25°C

Note 2: Units are g x mil / 100 in² x day @ 38°C, 50 - 90% RH

Factors for the Selection of a Plastic Container

Plastic containers have been developed for a variety of applications across many different industries over the years. There are many different types of polymers used in the creation of these containers to help fill the demands for the various applications. Polymers offer a variety of properties, each having different levels of importance with different users depending on the application. Some users may have flexibility within their product formula or filling process thus focus on economical containers while others may need containers that are stronger, autoclavable, transparent, sterilized, etc.; therefore requiring more specifications. DWK Life Sciences can help with polymer selection through comprehension of the customer’s product, goals, and adaptability. Several questions should be posed to gather this understanding.

Some Examples Include:

- What is the container size and physical design. Narrow mouth vs. wide mouth, tall vs. short, etc.?
- Must the package be transparent, translucent, opaque or colored for either marketing or light protection?
- Are there specific shipment and storage conditions such as refrigeration, freezing, exclusion of light, etc.?
- Are there governmental regulations pertaining to the product?
- How is the product going to be dispensed by the user?
- Have any tests been run in plastic? Were they unsuccessful and why? What type of plastics?

Many Things Govern Polymer Suitability for Package Use

These include:

- Permeation / Barrier
- Sorption Characteristics
- Chemical Resistance
- Stress Crack Resistance
- Rigidity / Flexibility
- Impact Resistance
- Sterilizability
- Recyclability
- Temperature Resistance
- Mold Release

Table 7. Packageability of Plastic Containers

Requirement	PC	PE	PET	PETG	PP	PS	PVC
Lightweight	6	2	5	5	1	3	6
Clarity	1	3	1	1	2	1	1
Toughness	3	1	2	1	3	9	8
Water Adsorption	6	2	3	3	2	4	2
Water Vapor Permeability	6	2	5	4	2	5	4
CO ₂ Permeability	7	6	2	3	5	9	3
O ₂ Permeability	7	7	2	3	6	8	2
Resistance: Acids	4	2	4	4	2	4	2
Resistance: Alkalis	7	2	5	5	2	2	2
Resistance: Oils	4	4	2	2	3	4	2
Resistance: Solvents	3	3	2	2	3	6	4
Resistance: High Humidity	6	1	1	1	1	1	1
Resistance: Sunlight	4	4	1	2	4	5	5
Resistance: Heat (hot fill)	1	3	1	1	2	5	1
Resistance: Cold	1	1	2	2	4	5	9

This chart is a generalization to aid in selection; there are many forms, thicknesses and various copolymers and additives available. The lower the number, the better the property. 1=Excellent; 9=Poor. (PE Properties are similar for HDPE & LDPE.)

Biological Properties of Plastics

Plastic products and containers are considered to be biologically inert. For example polyethylenes, fluoropolymers, polypropylene, polystyrene and polycarbonate are considered to be non-toxic to cell cultures. Distilled water for preparing culture media can be collected and stored in polyethylene containers.

Determining a Plastic Container Thread Finish

When a container finish is designated as 24-410, it means that the diameter across the outside of the threads is approximately 24mm. (See 'T' dimension on illustration.) The 410 designates a specific style of thread. Table 8 shows average dimensions for comparison and to aid in sizing. The actual dimensions may vary slightly.

Opening Dimension of Plastic Containers with Thread Finish

The minimum opening dimension 'I' of a plastic container can be found if the container's thread finish is known. If the thread size of the container is 38-400, the 'I' can be determined from Table 8 by looking down the 'T' Dimension column (far left) until you find the number 38. Follow this row to the right, until you come to the 'I' min. column that is listed under the number 400. This number is the minimum opening of the container. The opening can be larger, but it should not be smaller.

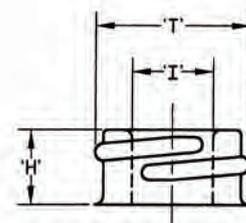

Table 8. Plastic Thread Finish Dimensions (Dimensions are in millimeters)

'T' Dim (mm)	400		410		415		425	
	'H'	'I' min	'H'	'I' min	'H'	'I' min	'H'	'I' min
13	—	—	—	—	11.48	5.54	7.87	5.54
15	—	—	—	—	14.15	6.55	7.87	6.55
18	9.42	8.25	13.28	8.25	15.67	8.25	—	—
20	9.42	10.26	14.07	10.26	18.85	10.26	—	—
22	9.42	12.27	14.86	12.27	21.26	12.27	—	—
24	10.16	13.11	16.41	13.11	24.31	13.11	—	—
28	10.16	15.59	17.98	15.59	27.48	15.59	—	—
30	10.24	16.59	—	—	—	—	—	—
33	10.24	20.09	—	—	—	—	—	—
35	10.24	22.22	—	—	—	—	—	—
38	10.24	25.07	—	—	—	—	—	—
40	10.24	27.71	—	—	—	—	—	—
43	10.24	29.59	—	—	—	—	—	—
45	10.24	31.77	—	—	—	—	—	—
48	10.24	35.08	—	—	—	—	—	—
51	10.36	37.57	—	—	—	—	—	—
53	10.36	40.08	—	—	—	—	—	—
58	10.36	44.07	—	—	—	—	—	—
60	10.36	47.07	—	—	—	—	—	—
63	10.36	50.09	—	—	—	—	—	—
66	10.36	53.09	—	—	—	—	—	—
70	10.36	57.07	—	—	—	—	—	—
75	10.36	61.57	—	—	—	—	—	—
77	12.37	64.67	—	—	—	—	—	—
83	12.37	69.93	—	—	—	—	—	—
89	13.59	74.12	—	—	—	—	—	—
100	15.16	84.94	—	—	—	—	—	—
110	15.16	94.92	—	—	—	—	—	—
120	17.40	104.93	—	—	—	—	—	—

Sterilization of Plastics

There are a variety of plastic materials and methods by which these plastic materials can be sterilized. However, not all plastics can be sterilized by every method. An understanding of sterilization methods, problems that can occur, and terms associated with sterilization is helpful in determining plastic and plastic ware capability and performance. The following is presented to assist in gaining that understanding.

Exposure To Non-Sterile Conditions Causes Non-Sterility

While temperature and time used to melt thermoplastics kills microorganisms, manufactured ware will not remain sterile unless it is made and maintained in a sterile environment. Plastic ware is not "sterile as manufactured" since:

- Ware is not blown with sterile air
- Ware may be exposed to non-sterile conditions immediately after manufacture
- Ware may contact non-sterile atmosphere, bags, boxes, personnel, etc. during packing after ware manufacture or during unpacking at the filling location
- Low particulate does not mean sterile

Producing ware under a shroud and using "particulate-free" or "low particulate" clean room bags does not result in sterile ware. These steps only reduce particulate in and on the ware to a lower level than would be present if ware were produced in an "unshrouded" production situation. In the future, molding may be performed in clean rooms and sterile conditions maintained after ware manufacture, however, until that time, ware cannot be represented as being sterile as molded. Until then, a secondary sterilization process must be performed.

Terms Associated with Sterilization

Bioburden

This is the number of microorganisms (bacteria, virus, fungi, etc.) present. Microbiologists can test for these. When sterilizing ware, it is important to eliminate the bioburden to prevent further microbial growth.

Pyrogens

A pyrogen, which means fever causing, is a remnant of bacteria that contains chemicals called endotoxins. Endotoxins can cause fever if injected into a mammal. Several tests exist to identify endotoxin contamination. Something may be sterile, but still have pyrogens on it. Glass can be sterilized and de-pyrogenated at the same time. Exposure to high temperature (600°F or higher) will kill microorganisms AND burn up endotoxins. The higher the temperature, the shorter the exposure time needed for de-pyrogenation. Most plastic ware is incapable of being exposed to these high temperatures. Therefore, plastic ware may be sterilized but, if it needs to be de-pyrogenated, it is usually washed with pyrogen free water.

RNase and DNase

Contaminating enzymes; RNase (which breaks down RNA), and DNase (which breaks down DNA), are the most critical substances influencing experimental work in molecular biology. These contaminants are one of the principle causes of failure in the manipulation and analysis of RNA and DNA in the laboratory. These enzymes come primarily from contact with skin (direct and indirect). Pipettors, lab benches, autoclaves, lab ware, doorknobs, etc. are all frequently handled without gloves. All of these items, and virtually everything in a lab setting, are contaminated with these enzymes after contact with skin. Wearing gloves only offers protection until a surface is contacted that has itself contacted skin, at which time the glove becomes contaminated. Because of the resiliency of these enzymes, maintaining a RNase / DNase – free lab is extremely difficult.

Steam autoclaving ware at 121°C for 20 minutes will destroy DNase, but will not destroy RNase. Baking ware in an oven at 300°C for 4 hours will destroy DNase and RNase. However, this method is not possible with most plastic items because of the high temperature. Alternatively, there are decontaminating cleansing solutions available in the marketplace that will destroy both of these enzymes immediately upon contact and can be used with most materials. The solution is simply sprayed onto the surface of the ware, which is then rinsed thoroughly with nuclease-free water.

Sterilization Techniques

Sterilization techniques are designed to kill microorganisms. There are varieties of sterilization methods, however the three basic approaches used to sterilize plastic ware are:

- Ethylene Oxide (EtO) Exposure
- Steam Autoclave
- Radiation (gamma radiation, electron beam radiation)

Tests should always be run on plastic ware to determine suitability for a given sterilization method.

Ethylene Oxide

Ethylene oxide (EtO) is a toxic, cancer causing gas. Technology and worker protection legislation allow continued EtO use. Most plastic can be EtO sterilized. EtO must contact the surfaces to be sterilized. There are several ways EtO sterilization can be accomplished.

Pure EtO

Empty ware in an open bag or ware in a sealed bag with a "breather" window, is placed in a chamber. Air is evacuated and moisture introduced (dry microorganisms are resistant to EtO sterilization).

Pure EtO is flooded into the chamber. Chamber internal pressure is kept lower than external pressure to ensure gas will not leak. Exposure time varies depending on ware and bioburden. After exposure, the chamber is purged with filtered sterile air to eliminate residual EtO.

Dilute EtO

Since it is safer than pure EtO, a 10-15% mixture of EtO with inert gas is used. Empty ware in an open bag or ware in a sealed bag with a "breather window" is placed in a chamber. Air is evacuated, and moisture is introduced (dry microorganisms are resistant to EtO sterilization). Dilute EtO is flooded into the chamber and the chamber's temperature increased up to 60°C (140°F). Exposure time of 4 to 24 hours varies depending on ware, bioburden, and sterilization parameters. After exposure, the chamber is purged with filtered sterile air to eliminate residual EtO.

Most plastic ware is capable of being EtO sterilized. However, zinc stearate process aid, used in injection blow molding, can cause precipitants (particulate) to form in liquid products packaged in EtO sterilized ware.

Therefore, only special LDPE grades and colorants that do not require zinc stearate for injection blow molded ware should be treated by EtO sterilization processes. Additionally, tests should always be run on plastic ware to determine suitability for a given sterilization method.

Steam Autoclave

Autoclaving can sterilize empty OR filled, sealed ware. The effect of temperature AND moisture kills microorganisms. Autoclaving involves exposing ware for a time to steam. The autoclave acts like a pressure cooker, allowing the steam temperature to get above the boiling point of water (100°C=212°F). Typically, autoclaving is done at 15 psi (pounds per square inch) steam being at 121°C (250°F).

Autoclaving Empty Ware

Empty ware must withstand autoclaving temperature for the exposure time. If it does not, parts will distort. Of the common plastics, polypropylene (PP) and polycarbonate (PC) have enough heat resistance to be autoclaved. Generally, PP homopolymer is slightly more heat resistant than PP copolymer. Also, there is a grade of a new transparent plastic material identified as a cyclic olefin copolymer (COC) that is capable of withstanding steam autoclave sterilization.

Steam Autoclave (Cont.)

If empty ware becomes distorted due to autoclave sterilization, it may be due to:

- High stresses molded into the ware during manufacture
- Unusual hot spots in the autoclave
- Use of the wrong plastic

Tests should always be run on plastic ware to determine suitability for a given sterilization method.

Autoclaving Filled, Sealed Ware

Autoclave sterilization of filled, sealed ware, is also known as "Terminal Sterilization". Many companies prefer terminal sterilization IF their product can withstand the rigors. Autoclave temperature must be minimally 121°C (250°F). Of the common plastics, polypropylene (PP) and polycarbonate (PC) have enough heat resistance to be autoclaved. Also, there is a grade of a new transparent plastic material identified as a cyclic olefin copolymer (COC) that is capable of withstanding steam autoclave sterilization. However, autoclaving filled, sealed plastic ware is tricky. Temperature and pressure in the autoclave must be controlled and balanced with temperature and pressure being generated in the filled, sealed ware during autoclave heat up AND cool down. If not, ware could be crushed or ballooned. Special autoclaves are sold to enable this temperature / pressure balancing act.

If filled, sealed containers become distorted during autoclave sterilization. This may be due to:

- Improper balancing of temperature / pressure upon heating or cooling
- High stresses molded into ware at the time of manufacture
- Unusual hot spots within the autoclave chamber
- Use of the wrong plastic

Tests should always be run on plastic ware to determine suitability for a given sterilization method.

Autoclaving Closures

Polypropylene (PP) closures should be capable of withstanding steam autoclave sterilization. However, autoclaving may cause blooming of additives in PP. PP homopolymer is more heat resistant than PP copolymer. Linerless closures (closures with specially molded-in sealing features) may or may not be acceptable for autoclaving dependent on many factors (e.g. as application torque, autoclave conditions, closure design, etc.) If a closure is lined, the liner and the adhesive used to affix the liner inside the closure must also be considered. Lastly, PP closures applied to containers present a special case. Closures are designed with tolerances that cause interference between the closure and container. This interference results in stress. Since all thermoplastics become softer as temperature increases, stress may be relieved or closure dimensions may change upon autoclaving. This can result in closure torque reduction or seal loss.

If closures distort or a torque retention problem results, it may be due to:

- High stresses molded into ware at the time of manufacture
- Unusual hot spots within the autoclave chamber
- Use of the wrong plastic

Due to moisture absorption, pulp liners are NOT anticipated to be acceptable for autoclaving. Tests should always be run on plastic ware and liner / adhesive combinations to determine suitability for a given sterilization method.

Radiation

Ware is exposed to ionizing radiation that knocks electrons off atoms it contacts. Ionizing radiation is lethal to microorganisms because of its destructive effect upon the contents of living cells. There are two common sources of ionizing radiation used for sterilization:

- Cobalt 60 (gamma radiation) OR
- Electron beam or E-beam (high energy electrons)

The amount of radiation from either Cobalt 60 or electron beam is measured in MegaRads (MRads) or KiloGrays (KGy). One MegaRad equals ten KiloGrays. Because gamma sterilization and E-beam both use radiation, packaging materials react similarly in both systems.

Cobalt 60 Gamma Radiation

A gamma radiation sterilization facility consists of a thick walled concrete maze in a room built around a well filled with water. In the well are a number of pencil-sized steel rods impregnated with radioactive Cobalt. Articles to be sterilized are placed on conveyors that bring them through the concrete maze into the room where the radioactive rods are located. The number of rods raised from the well and the exposure time controls the degree of exposure. After exposure, ware is conveyed from the room via the maze.

A radiation dose sufficient to kill bacteria and spores is about 2.5 MRads. To minimize costs plus attain sterilization, bioburden is determined then the minimum dosage plus a safety factor is selected.

Gamma radiation has high penetrating power (about 50 cm or close to 20 inches of the same unit-density material). Thus, many parts can be packed together for sterilization. In this instance, the dosage reaching the center of ware multi-packs is validated. Slightly higher doses occur at the outside edges of multi-packs.

Usually, empty packaging components are sterilized via gamma radiation. Since effects of radiation are cumulative, twice the normal dose is sometimes examined to insure minimal problems.

Listed below are thermoplastic materials that are recognized as capable of being gamma radiation sterilized, although tests should always be run on plastic ware to determine suitability for a given sterilization method:

- Low Density Polyethylene
- Linear Low Density Polyethylene
- High Density Polyethylene (those containing phosphite stabilizers may yellow)
- Polyethylene Terephthalate
- Polystyrene
- Polycarbonate
- Nylon
- Cyclic Olefin Copolymers (a newly emerging group of polymers)
- Polyethylene Naphthalate (a newly emerging group of polymers)

Problems can occur when gamma radiation sterilizing polyvinyl chloride (PVC) or fluoropolymers (PTFE, etc.).

Important Note About Polypropylene Gamma Radiation Sterilization

Normal PP grades yellow noticeably and exhibit long term embrittlement when sterilized via gamma radiation techniques. Special radiation resistant PP grades, having special stabilizers, are available for radiation sterilization. Also, if ware is to be colored, then the concentrate carrier should be a radiation resistant grade of PP. PP copolymers are more radiation resistant than PP homopolymers. Tests should always be run on plastic ware to determine suitability for a given sterilization method.

Electron Beam (E-Beam) Radiation

An E-beam radiation sterilization facility consists of a protective maze built around an E-beam generator. The E-beam generator delivers a high dose of electrons focused in a narrow beam at the items to be sterilized. After exposure, ware is conveyed from the maze.

A radiation dose sufficient to kill bacteria and spores is about 2.5 MRads. To minimize costs and attain sterilization, bioburden is determined and the minimum dosage plus a safety factor is selected.

Electrons from the E-beam generator have limited penetrating power (a 10-MeV E-beam will penetrate only about 5 cm or 2 inches of a unit-density material). Thus, a limited number of parts can be packed together for sterilization. The dosage reaching the center of a ware multi-pack is validated. Higher dosages will occur at the outside edges of ware multi-packs.

Usually, empty packaging components are sterilized via E-beam. Since effects are cumulative, twice the normal dose is sometimes examined to insure minimal problems.

Listed below are thermoplastic materials that are recognized as capable of being electron beam radiation sterilized, although tests should always be run on plastic ware to determine suitability for a given sterilization method:

- Low Density Polyethylene
- Linear Low Density Polyethylene
- High Density Polyethylene (those containing phosphite stabilizers may yellow)
- Polyethylene Terephthalate
- Polystyrene
- Polycarbonate
- Nylon
- Cyclic Olefin Copolymers (a newly emerging group of polymers)
- Polyethylene Naphthalate (a newly emerging group of polymer)

Problems can occur when E-beam sterilizing polyvinyl chloride (PVC) or fluoropolymers (PTFE, etc.)

Important Note About Polypropylene E-Beam Sterilization

Normal PP grades yellow noticeably and exhibit long term embrittlement when sterilized via E-Beam. Special PP grades, having special stabilizers, are available for E-beam sterilization. Also, if ware is to be colored, then the concentrate carrier should be a radiation resistant grade of PP. PP copolymers are more radiation resistant than PP homopolymers. Tests should always be run on plastic ware to determine suitability for a given sterilization method.

DISCLAIMER: The data and information contained herein are limited to illustrative examples that are based on limited testing procedures. However, due to variable conditions of use and methods processing, **NO GUARANTEES OR WARRANTIES ARE EXPRESSED OR IMPLIED INCLUDING ANY IMPLIED WARRANTY OF MERCHANTABILITY OR FITNESS FOR A PARTICULAR PURPOSE.** DWK Life Sciences does not recommend any use that infringes patents. This data and information, and the products and processes described, are subject to change at any time without notice. Please contact your DWK Life Sciences representative with your specific packaging needs.



Resin Identification Codes

DWK Life Sciences follows the Society of the Plastics Industry (SPI) guidelines for marking plastic containers with the appropriate resin identification code numbers as shown below:

DWK Life Sciences mold-marks our containers on the bottom with the appropriate resin identification code. These codes are to assist in identifying material used to manufacture ware to aid in recycling efforts.

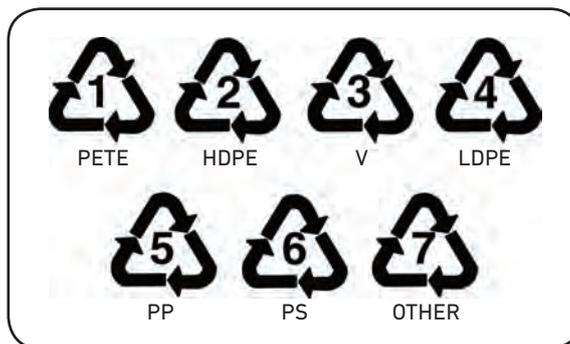

1 = PETE (polyethylene terephthalate) (PET)

2 = HDPE (high density polyethylene)

3 = V (vinyl / polyvinyl chloride) (PVC)

4 = LDPE (low density polyethylene)

5 = PP (polypropylene)

6 = PS (polystyrene)

7 = Other

Plug Styles

Country	Primary Plug Code	Voltage	Alt. Plug Code	Voltage
Afghanistan	C	220	—	—
Algeria	C	220	—	—
American Samoa	F	220	A	120
Angola	C	220	—	—
Anguilla (U.K.)	D	240	—	—
Antigua	D	240	A	120
Argentina	*	220	—	—
Armenia	C	220	—	—
Aruba	A	127	C	220
Australia	F	230	—	—
Austria	C	230	—	—
Azores (Portugal)	C	230	—	—
Bahamas	A	120	—	—
Bahrain	D	230/240	J	230/240
Bangladesh	J	230	D	230
Barbados	A	115	—	—
Belarus	C	220	—	—
Belgium	C	230	—	—
Belize	A	110	J	220
Benin	C	220	—	—
Bermuda	A	120	—	—
Bolivia	C	230	—	—
Bosnia-Herzegovina	C	220	—	—
Botswana	D	230	J	230
Brazil	A	127	—	—
Bulgaria	C	220	—	—
Burkina Faso	J	220/230	D	220/230
Burundi	C	220	—	—
Cambodia	C	220	—	—
Cameroon	C	220-260	—	—
Canada	A	120	—	—
Canary Islands	C	220	—	—
Cape Verde, Rep. of	C	220	—	—
Cayman Islands	A	120	—	—
Central African Rep.	C	220	—	—
Chad	C	220	—	—
Channel Islands	D	240	—	—
Chile	G	220	—	—
China, People's Rep.	F	220	—	—
Christmas Is.	F	240	—	—
Cocos Is. (Australia)	F	240	—	—
Colombia	A	120	—	—
Congo, Rep. of	C	220-240	—	—
Cook Is. (N.Z.)	F	240	—	—
Costa Rica	D	240	A	120
Croatia	C	230	—	—
Cuba	A	115	C	230
Curacao Is.	A	110	C	220
Cyprus	D	230	J	230
Czech, Rep. of	C	230	—	—
Denmark	I	230	—	—
Djibouti, Rep. of	C	220	—	—
Dominica	D	230	J	230
Dominican Rep.	A	120	—	—
Ecuador	A	110	—	—
Egypt	D	220	C	220
El Salvador	A	120	—	—
England	D	230	J	230
Equatorial Guinea	*	220	—	—
Estonia	C	220-230	—	—
Ethiopia	G	230	—	—
Fiji	F	240	—	—
Finland	C	230	—	—
France	C	230	—	—
French Guiana	C	220	—	—
Gabon	C	220	—	—
Gambia	D	220	J	220
Germany	C	230	—	—
Ghana	D	220	J	220
Gibraltar	D	240	J	240

Country	Primary Plug Code	Voltage	Alt. Plug Code	Voltage
Greece	C	230	—	—
Greenland (Denmark)	I	230	—	—
Grenada	D	230	J	230
Guadeloupe	C	220	—	—
Guam	A	120	—	—
Guatemala	A	110	—	—
Guinea	C	220	—	—
Guinea-Bissau	C	220	—	—
Guyana	D	240	J	240
Haiti	A	110	—	—
Honduras	A	110	—	—
Hong Kong	D	220	J	220
Hungary	C	230	—	—
Iceland	C	230	—	—
India	J	230	—	—
Indonesia	C	220	—	—
Iran	C	220	—	—
Iraq	D	220	C, J	220
Ireland, Rep. of (S.)	D	230	—	—
Israel	K	230	—	—
Italy	G	230	—	—
Ivory Coast	C	230	—	—
Jamaica	A	110	—	—
Japan	B	100	—	—
Jordan	D	230	C	230
Kenya	D	240	J	240
Kuwait	D	230	J	230
Kyrgyzstan	C	220	—	—
Laos	C	220	—	—
Latvia	C	220	—	—
Lebanon	D	220	C, J	220
Lesotho	D	220	J	220
Liberia	C	220-230	—	—
Libya	J	220	C	220
Liechtenstein	L	230	—	—
Lithuania	C	230	—	—
Luxembourg	C	230	—	—
Macao	J	220	D	220
Madagascar	C	220	—	—
Malawi	D	230	J	230
Malaysia	D	240	J	240
Maldives	D	220	J	220
Mali, Rep. of	C	220	—	—
Malta	D	230	—	—
Martinique	C	230	—	—
Mauritania	C	220	—	—
Mauritius	D	230	J	230
Mexico	A	127	—	—
Moldova	C	220	—	—
Monaco	C	220	—	—
Mongolia	C	220	—	—
Montseurrat	D	230	—	—
Morocco	C	220	—	—
Mozambique	J	220	C	220
Myanmar	D	230	J	230
Namibia (W.S. Africa)	D	220	J	220
Nepal	J	220	—	—
Neth. Antilles	A	115-127	C	220
Netherlands	C	230	—	—
New Caledonia	C	220	—	—
New Zealand	F	230	—	—
Nicaragua	A	120	—	—
Niger	C	220	—	—
Nigeria	D	230	J	230
No. Ireland	D	230	—	—
North Korea	C	220	—	—
Norway	C	230	—	—
Oman	D	240	C, J	240
Pakistan	J	230	—	—
Panama	A	120	—	—

Country	Primary Plug Code	Voltage	Alt. Plug Code	Voltage
Papua New Guinea	F	240	—	—
Paraguay	C	220	—	—
Peru	C	220	—	—
Philippines	*	220	—	—
Pitcairn Is. (U.K.)	J	240	—	—
Poland	C	230	—	—
Portugal	C	230	—	—
Puerto Rico	A	120	—	—
Qatar	D	240	J	240
Romania	C	230	—	—
Russian Federation	C	220	—	—
Rwanda	C	220	L	220
Saudi Arabia	A	127	C, D, J	220
Scotland	D	230	—	—
Senegal	J	220	C	220
Seychelles	D	230	J	230
Sierra Leone	D	230	J	230
Singapore	D	230	J	230
Slovakia	C	230	—	—
Slovenia	C	220	—	—
Somalia	J	220-230	—	—
South Africa	J	220-250	D	220-250
South Korea	A	120	C	220
Spain	C	230	—	—
Sri Lanka	J	230	D	230
St. Kitts & Nevis	D	230	J	230
St. Lucia	D	240	—	—
St. Pierre & Miquelon	A	115	—	—
St. Vincent	D	230	—	—
Sudan	J	240	J	240
Suriname	A	127	C	220
Svalbard (Norway)	C	220	—	—
Swaziland	D	230	J	230
Sweden	C	230	—	—
Switzerland	L	230	—	—
Syria	C	220	—	—
Tahiti	C	220	A	110-127
Taiwan	A	110	F	220
Tanzania	D	230	J	230
Thailand	C	220	—	—
Togo	C	230	—	—
Tonga	F	240	—	—
Trinidad and Tobago	A	115	—	—
Tunisia	C	220	—	—
Turkey	C	220	D, J	220
Uganda	D	240	J	240
Ukraine	C	220	—	—
United Arab Emirates	D	220-240	J	220-240
United Kingdom	D	230	J	230
United States	A	120	—	—
Uruguay	C	220	G	220
Venezuela	A	120	—	—
Vietnam	C	220	—	—
Virgin Islands	A	120	—	—
Wales	D	230	J	230
Western Samoa	F	230	—	—
Yemen	D	250	J	250
Yugoslavia	C	230	—	—
Zaire, Rep. of	C	220-240	—	—
Zambia	D	230	J	230
Zimbabwe	D	220-230	J	220-230

* Additional plug styles may be available through special order. Please contact DWK Life Sciences Technical Services for additional information.

Plug Style Codes

Plug Code "A":
North America Plug



Plug Code "B":
Japan Plug

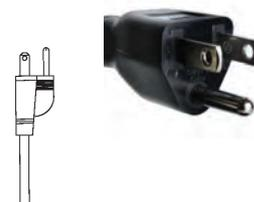

Plug Code "C":
Continental Europe Plug

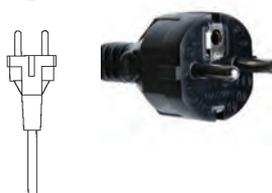

Plug Code "D":
United Kingdom Plug



Plug Code "F":
Australia/China Plug



Plug Code "G":
Italy/Chile Plug



Plug Code "I":
Denmark Plug



Plug Code "J":
India Plug



Plug Code "K":
Israel Plug



Plug Code "L":
Switzerland Plug



Common Conversion Factors

Convert From	Convert Into	Multiply By
Angstrom units	Centimeter	1.0×10^{-8}
	Inches	3.9370×10^{-9}
	Microns	0.0001
	Millimeters	1.0×10^{-7}
	Mils	3.9370×10^{-6}
Atmospheres (std.)	Bars	1.01325
	Inches of Hg @ 32°F	29.9213
	Millibars	1013.25
	Mm of Hg @ 0°C	760.0
	Torr	760.0
Bars	Atmospheres (std.)	0.98692
	Inches of Hg @ 32°F	29.5299
	Millibars	1000.00
	Mm of Hg @ 0°C	750.062
	Torr	750.062
Centimeters	Angstrom units	1.0×10^8
	Inches	0.39370
	Microns	1.0×10^4
	Millimeters	10.0
	Mils	393.701
Cubic Centimeters	Cubic Inches	0.06102
	Drams (fluid)	0.27051
	Gallons (UK liquid)	2.1997×10^{-4}
	Gallons (US liquid)	2.6417×10^{-4}
	Liters	1.0×10^{-3}
	Milliliters	1.0
	Ounces (UK liquid)	0.03519
	Ounces (US liquid)	0.03381
Cubic Inches	Cubic Centimeters	16.3871
	Drams (fluid)	4.43290
	Gallons (UK liquid)	3.6046×10^{-3}
	Gallons (US liquid)	4.3290×10^{-3}
	Liters	0.01639
	Milliliters	16.3871
	Ounces (US liquid)	0.57674
Ounces (UK liquid)	0.55411	
Drams (fluid)	Cubic Centimeters	3.69672
	Cubic Inches	0.22559
	Gallons (UK liquid)	8.1316×10^{-4}
	Gallons (US liquid)	9.7657×10^{-4}
	Liters	3.6967×10^{-3}
	Milliliters	3.69672
	Ounces (UK liquid)	0.13011
	Ounces (US liquid)	0.12500
Gallons (UK liquid)	Cubic Centimeters	4546.09
	Cubic Inches	277.419
	Drams (fluid)	1229.76
	Gallons (US liquid)	1.20095
	Liters	4.54609
	Milliliters	4546.09
	Ounces (UK liquid)	160.0
	Ounces (US liquid)	153.722
Gallons (US liquid)	Cubic Centimeters	3785.41
	Cubic Inches	231.0
	Drams (fluid)	1023.99
	Gallons (UK liquid)	0.83267
	Liters	3.78541
	Milliliters	3785.41
	Ounces (UK liquid)	133.228
	Ounces (US liquid)	128.0
Grams	Kilograms	1.0×10^{-3}
	Ounces (avdp)	0.03527
	Ounces (troy)	0.03215
	Pounds (avdp)	2.2046×10^{-3}
	Pounds (troy)	2.6791×10^{-3}
Inches	Angstrom units	2.540×10^8
	Centimeters	2.54
	Microns	25400.0
	Millimeters	25.40
	Mils	1000.0
Inches of Hg @ 32°F	Atmospheres (std.)	0.03342
	Bars	0.03386
	Millibars	33.8639
	Mm of Hg @ 0°	25.4000
	Torr	25.4000
Kilograms	Grams	1000.00
	Ounces (avdp)	35.2739
	Ounces (troy)	32.1505
	Pounds (avdp)	2.20462
	Pounds (troy)	2.67921

Temperature	°C = (°F - 32) x 0.56
	°F = (°C x 1.8) + 32
Power	Amperage = Wattage / Voltage
	Voltage = Wattage / Amperage
	Wattage = Voltage x Amperage

Convert From	Convert Into	Multiply By
Liters	Cubic Centimeters	1000.03
	Cubic Inches	61.0237
	Drams (fluid)	270.510
	Gallons (UK liquid)	0.21997
	Gallons (US liquid)	0.26418
	Milliliters	1000.03
	Ounces (UK liquid)	35.1951
	Ounces (US liquid)	33.8149
Microns	Angstrom units	10000.0
	Centimeters	1.0×10^{-4}
	Inches	3.9370×10^{-5}
	Millimeters	1.0×10^{-3}
Mils	0.03937	
Millibars	Atmosphere (std.)	9.8692×10^{-4}
	Bars	1.0×10^{-3}
	Inches of Hg @ 32°F	0.02953
	Mm of Hg @ 0°C	0.75006
	Torr	0.75006
Milliliters	Cubic Centimeters	1.0000
	Cubic Inches	0.06102
	Drams (fluid)	0.27051
	Gallons (UK liquid)	2.1997×10^{-4}
	Gallons (US liquid)	2.6417×10^{-4}
	Liters	1.0×10^{-3}
	Ounces (UK fluid)	0.03519
Ounces (US fluid)	0.03381	
Millimeters	Angstrom units	1.0×10^7
	Centimeters	0.10
	Inches	0.03937
	Microns	1000.0
	Mils	39.3701
Millimeters Hg @ 0°C	Atmospheres (std.)	1.3158×10^{-3}
	Bars	1.3332×10^{-3}
	Inches of Hg @ 32°F	0.03937
	Millibars	1.333221
	Torr	1.0
Mils	Angstrom units	254000.0
	Centimeters	2.540×10^{-3}
	Inches	1.0×10^{-3}
	Microns	25.40
	Millimeters	0.0254
Ounces (avdp)	Grams	28.3495
	Kilograms	0.02835
	Ounces (troy)	0.91146
	Pounds (avdp)	0.06250
	Pounds (troy)	0.07596
Ounces (troy)	Grams	31.1035
	Kilograms	0.03110
	Ounces (avdp)	1.09714
	Pounds (avdp)	0.06857
	Pounds (troy)	0.08333
Ounces (UK liquid)	Cubic Centimeters	28.4131
	Cubic Inches	1.73387
	Drams (fluid)	7.68603
	Gallons (UK liquid)	6.250×10^{-3}
	Gallons (US liquid)	7.8125×10^{-3}
	Liters	0.02841
	Milliliters	28.4131
	Ounces (US liquid)	0.96076
Ounces (US liquid)	Cubic Centimeters	29.5735
	Cubic Inches	1.80469
	Drams (fluid)	8.0
	Gallons (UK liquid)	6.5053×10^{-3}
	Gallons (US liquid)	7.8125×10^{-3}
	Liters	0.02957
	Milliliters	29.5735
	Ounces (UK liquid)	1.04084
Pounds (avdp)	Grams	453.592
	Kilograms	0.45359
	Ounces (avdp)	16.0
	Ounces (troy)	14.5833
Pounds (troy)	1.21528	
Pounds (troy)	Grams	373.242
	Kilograms	0.37324
	Ounces (avdp)	13.1657
	Ounces (troy)	12.0
	Pounds (avdp)	0.82286
Torr	Atmospheres (std.)	1.3158×10^{-3}
	Bars	1.3332×10^{-3}
	Inches of Hg @ 32°F	0.03937
	Millibars	1.33322
	Mm of Hg @ 0°C	1.0

Chemical Compatibility

Chemical	Container Materials							Closure Liner Materials					Closure Materials				Septa, Stopper & Tubing Materials						
	Glass	HDPE	LDPE	PC	PET	PETG	PP	Al Foil	LDPE	Poly-Vinyl	PTFE	SBR	Silicone	PBT	Phenolic	PP	Urea	Butyl Rubber	Natural Rubber	FKM	PTFE	Silicone	TPE
Acetic acid, Glacial	A	A	B	C	A	C	A	A	B	B	A	C	B	C	A	A	D	B	D	B	A	B	B
Acetone	A	D	D	D	C	D	B	A	D	D	A	D	B	D	A	B	A	B	D	B	A	B	D
Acetonitrile	A	A	A	D	B	C	A	A	A	D	A	B	D	-	A	A	-	D	D	D	A	D	D
Acrylonitrile	A	A	A	D	B	-	B	B	A	D	A	C	D	-	D	B	-	D	D	D	A	D	-
Ammonium Sulfide	A	A	A	D	-	-	A	D	A	A	A	B	A	-	A	A	C	A	C	A	A	A	B
Benzene	A	D	D	D	C	D	D	B	D	D	A	D	D	A	A	D	A	D	A	D	A	D	D
Bleach	A	A	B	B	C	C	B	D	B	A	A	D	B	C	D	B	-	A	A	D	A	B	A
Boric Acid	A	A	A	A	A	A	A	D	A	A	A	A	A	A	B	A	-	A	A	A	A	A	B
Carbonic Acid	A	A	A	A	-	A	A	B	A	A	A	B	A	B	-	A	-	A	A	A	A	A	D
Chlorobenzene	A	C	D	D	B	C	C	A	D	D	A	D	D	B	A	C	B	D	A	D	A	D	D
Chloroform	A	C	C	D	D	D	D	A	C	D	A	D	D	D	A	D	A	D	A	D	A	D	D
Dichloromethane (DCM)	A	C	D	D	D	D	C	D	D	D	A	D	D	D	C	C	B	D	B	D	A	D	D
Diethylamine	A	C	D	D	-	-	B	A	D	D	A	B	B	-	-	B	-	B	C	B	A	B	-
Dimethyl Formamide (DMF)	A	A	A	D	B	C	A	A	A	D	A	D	B	C	A	A	-	D	D	D	A	B	C
Dimethyl Sulfoxide (DMSO)	A	A	A	D	B	C	A	A	A	D	A	D	D	C	-	A	-	D	D	D	A	D	-
Dioxane	A	B	B	D	A	A	D	D	B	D	A	D	D	B	A	D	-	B	D	D	A	D	-
Ether	A	C	D	D	A	A	D	B	D	D	A	D	D	A	B	D	B	D	C	D	A	D	D
Ethyl Acetate	A	B	B	D	B	C	C	B	B	D	A	D	C	C	A	C	B	C	D	D	A	C	D
Ethyl Alcohol	A	A	A	A	A	A	A	B	A	B	A	A	B	A	B	A	A	A	A	A	A	B	B
Ethylene Glycol	A	A	A	A	A	A	A	B	A	A	A	A	A	A	B	A	B	A	A	A	A	A	B
Formaldehyde	A	A	A	A	B	A	A	A	A	C	A	B	B	A	B	A	A	A	C	C	A	B	A
Formic Acid 50%	A	A	B	B	-	-	A	C	B	B	A	B	C	A	C	A	D	A	C	B	A	C	B
Gasoline	A	C	D	C	B	B	C	A	D	D	A	D	D	A	B	C	A	D	A	D	A	D	D
Glycerine	A	A	A	A	-	A	A	A	A	C	A	A	B	A	A	A	-	A	A	A	A	B	B
Heptane	A	C	D	B	B	-	C	A	D	C	A	D	D	A	A	C	A	D	A	D	A	D	C
Hexane	A	B	D	C	C	B	B	A	D	D	A	D	D	A	B	B	-	D	A	D	A	D	B
Hydrochloric Acid (HCL) 50%	A	A	A	D	B	C	A	D	A	B	A	D	D	C	A	A	D	A	A	B	A	D	B
Hydrofluoric Acid (HF) 50%	D	A	A	D	C	D	A	D	A	C	A	D	D	C	D	A	D	C	A	C	A	D	A
Hydrogen Peroxide 50%	B	A	A	A	B	B	A	A	A	C	A	C	B	B	D	A	D	B	A	B	A	B	B
Iodine	A	C	D	C	A	-	C	A	D	C	A	B	A	D	-	C	-	B	A	D	A	A	D
Isopropyl Alcohol	A	A	A	A	A	A	A	A	A	B	A	B	A	A	A	A	-	A	A	A	A	A	B
Methyl Alcohol	A	A	A	B	B	A	A	A	A	C	A	A	A	B	B	A	A	A	D	A	A	A	A
Methyl Ethyl Ketone (MEK)	A	D	D	D	B	C	B	A	D	D	A	D	D	C	A	B	-	A	D	D	A	D	B
Methylene Chloride	A	C	D	D	D	D	C	D	D	D	A	D	D	D	C	C	B	D	B	D	A	D	D
Nitric Acid 50%	A	C	B	B	C	B	C	D	B	B	A	D	D	C	B	C	D	C	B	C	A	D	B
Pentane	A	C	C	A	-	-	D	A	C	D	A	D	D	B	-	D	-	D	A	D	A	D	B
Perchloric Acid 50%	B	B	B	D	B	C	B	D	B	D	B	D	D	-	-	B	-	B	A	D	B	D	A
Phenol 50%	A	D	D	D	D	D	D	A	D	C	A	D	D	D	A	D	-	D	A	D	A	D	D
Phosphoric Acid 50%	A	A	A	A	B	-	A	B	A	B	A	D	D	B	B	A	D	B	A	D	A	D	A
Picric Acid	A	D	D	D	B	-	D	A	D	D	A	B	D	D	A	D	D	B	A	B	A	D	D
Potassium Hydroxide	D	A	A	D	D	D	A	D	A	A	A	B	C	C	D	A	-	A	B	B	A	C	A
Sodium Hydroxide 50%	D	A	B	D	D	C	A	D	B	C	A	A	B	C	D	A	C	A	B	A	A	B	C
Sodium Peroxide	A	B	B	A	-	-	B	C	B	A	A	B	D	B	B	B	D	A	A	B	A	D	A
Sodium Thiosulfate	A	A	A	B	B	-	A	A	A	A	A	B	A	B	A	A	B	A	A	B	A	A	-
Sulfuric Acid 50%	A	A	A	B	B	C	B	C	A	C	A	D	D	B	C	B	D	D	A	D	A	D	A
Tetrahydrofuran (THF)	A	C	C	D	B	D	B	A	C	D	A	D	D	D	A	B	-	C	D	D	A	D	D
Toluene	A	C	C	D	C	C	C	A	C	C	A	D	D	D	A	C	-	D	B	D	A	D	D
Trifluoroacetic Acid (TFA) 50%	A	A	A	D	B	-	A	B	A	A	A	B	D	-	-	A	-	B	C	B	A	D	-
Vegetable Oil	A	B	B	A	A	A	A	A	B	A	A	D	A	A	A	A	A	C	A	D	A	A	-
Xylene	A	C	D	D	C	-	D	A	D	D	A	D	D	C	A	D	B	D	A	D	A	D	D

(Tests conducted at room temp) **A** - Resistant **B** - Limited Resistance **C** - Poor Resistance **D** - Not Resistant **-** - Unknown

Al Foil ... aluminum foil **FKM** ... fluoroelastomer **HDPE** ... high density polyethylene **LDPE** ... low density polyethylene **PBT** ... polybutylene terephthalate

PC ... polycarbonate **PET** ... polyethylene terephthalate **PETG** ... polyethylene terephthalate g copolymer **PP** ... polypropylene **PTFE** ... polytetrafluoroethylene

SBR ... styrene butadiene rubber **TPE** ... thermoplastic Elastomer, C-Flex

Although the information in this chart was acquired from reputable sources, it should only be used as a guide in selecting a container and closure system. Because so many factors can affect the chemical resistance of a material, in-house testing under actual conditions should be performed. WHEATON accepts no responsibility for the accuracy of this data or for any consequences resulting from its use.

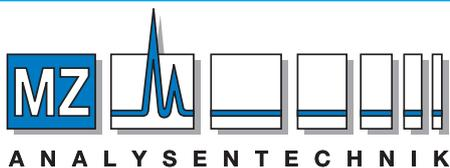
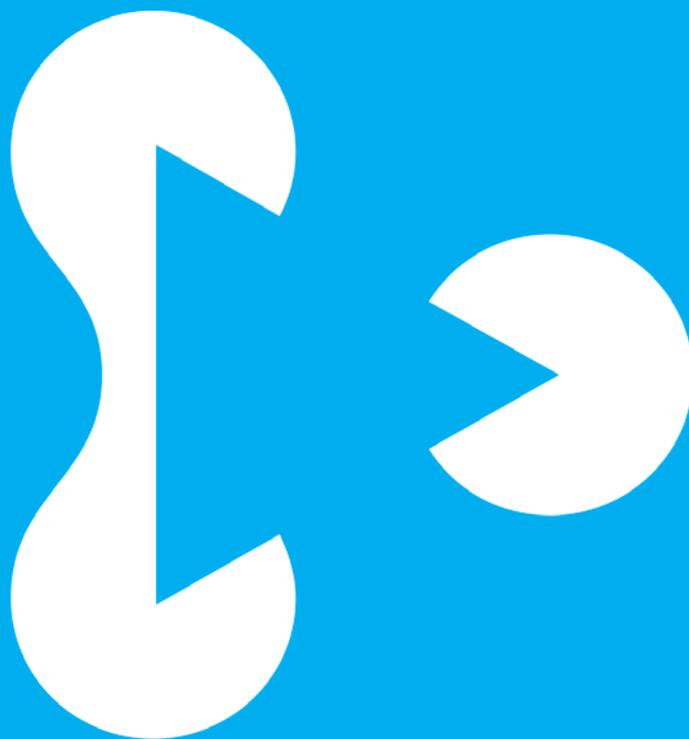

AUTHORIZED DISTRIBUTOR

MZ-Analysentechnik GmbH, Barcelona-Allee 17 • D-55129 Mainz

Tel +49 6131 880 96-0, Fax +49 6131 880 96-20

e-mail: info@mz-at.de, www.mz-at.de

Contact Info

DWK Life Sciences GmbH
Hattenbergstrasse 10
55122 Mainz
Germany

Phone: +49 (0)6131/1445 4131
Fax: +49 (0)6131/1445 4016
sales@DWK-LifeSciences.com
www.DWK-LifeSciences.com