



GENERAL CHROMATOGRAPHY

Your Essential Resource for Supplies

The Measure of Confidence



Agilent Technologies

GENERAL CHROMATOGRAPHY SUPPLIES



Minimize contamination and ensure accurate, reproducible results

As the world's premier measurement company, Agilent is uniquely positioned to offer you the widest selection of parts and supplies. All are engineered or selected by our experienced design teams, manufactured to our demanding specifications, and tested under the strictest conditions.



- **Vials, caps and septa** are designed to work flawlessly with your autosampler's gripping and injection mechanisms – eliminating breakage and leaks that can cause unnecessary downtime, expensive repairs, and sample loss. We have also expanded our portfolio to include MS analyzed kits, Agilent Certified Vials, and NEW Agilent CrossLab Vials for non-Agilent autosamplers.
- **Manual and autosampler syringes** boost performance along every step of your sampling process. Designed for accuracy, reliability and ease of use, Agilent syringes ensure exact measurement, transport, and delivery of liquids necessary for sample preparation and injection.
- **Renewable gas purification system** extends column life and reduces baseline noise by removing oxygen, water, and hydrocarbons from carrier gasses. One renewable cartridge can support up to four GC systems, while delivering the same filtration capacity as multiple competitive cartridges.
- **Gas Clean filter system** prevents dirty gas from jeopardizing your analysis. Oxygen, hydrocarbons, and moisture can decrease GC sensitivity; they can also activate glass wool in liners and accelerate septa degradation, causing high background noise and ghost peaks. Inserting a gas clean filter immediately before your GC inlet greatly reduces the level of impurities, improving trace analysis.
- **Fittings and tools** make life in the lab easier by keeping your instruments running in top form.
- **Electrochemistry meters** are designed by chromatographers for chromatographers to give you rugged simplicity and fast, reliable data. Features such as user-friendly controls, waterproof connectors, and multi-parameter measurement capabilities make Agilent pH, DO, ISE, conductivity and multi-parameter meters your first choice for a broad range of applications.



Table of Contents

Agilent Solutions, Services and Support	2	Agilent Syringes	60
Featured Products	6	Agilent Autosampler Syringes	63
Agilent Vials and Closures	8	Manual Syringes	69
MS Analyzed Vial Kits	14	Agilent CrossLab Syringes	77
Certified Screw Top Vials and Closures	15	CTC Autosampler Supplies	86
Crimp Top Vials and Closures	19	Gas Management	91
Certified Microvolume Inserts	21	Carrier Gas Purification	91
Polypropylene Vials and Closures	22	Gas Purification Systems	96
Headspace Vials and Closures	24	In-Line Gas Traps	101
Snap Top Vials and Closures	28	Flow Meters	110
Specialty Vials and Closures	30	Gas Leak Detector	111
General Purpose Vials and Caps	33	Regulators, Tubing, and Accessories	113
Crimping and Decapping Tools	34	Kits, Fittings, Tools and Accessories	115
Agilent CrossLab Vials and Closures	36	Electrochemistry	130
Agilent CrossLab Headspace Vials and Closures	40	Integrators, Integrator Supplies, and Cables	148
Agilent CrossLab Screw Top Vials and Closures	43	Indices	151
Agilent CrossLab Crimp Top Vials and Closures	49	Ordering Information	158
Agilent CrossLab Snap Top Vials and Closures	51		
Agilent CrossLab Polypropylene Vials	54		
Agilent CrossLab Micro-V Vials	54		
Agilent CrossLab Microvolume Inserts	55		
Agilent CrossLab Well Plates and Accessories	57		

PUT MORE THAN 40 YEARS OF RELENTLESS INNOVATION BEHIND YOUR EVERY RESULT

By continually raising the standards for technologies that support your routine analyses, Agilent's R&D efforts have led to breakthroughs such as:

- **New GC columns** that help you achieve higher levels of inertness and column-to-column reproducibility
- **LC column choices** that deliver the sensitivity and reliability you need for demanding applications
- **Cutting-edge sample preparation products** that promote reliable extraction and concentration
- **Fresh atomic and molecular spectroscopy ideas** for identifying and confirming targets and unknowns

Longtime Agilent customers have experienced our commitment firsthand. And now, we look forward to demonstrating how Agilent's approach to relentless innovation can work to your advantage, too.

CHEMICAL ANALYSIS SOLUTIONS



Food

From high-volume screening of vegetables for large numbers of pesticides to rapid identification of pathogens, Agilent understands the analytical needs of food producers, shippers, and regulators. When a new toxin appears, we deploy substantial resources to quickly help customers develop robust and reliable methods. Agilent's leading separations, mass spectrometry, and spectroscopy solutions are emerging as valuable food testing techniques.

Environmental

Agilent offers more than 40 years of environmental testing and regulatory expertise. We help government and private labs with the full range of assays, from routine testing of soils for heavy metals to detection of pharmaceuticals in groundwater, in concentrations down to parts per trillion.

Energy and Fuels

Agilent collaborates closely with process industry customers to offer analytical systems that meet their needs for separation, detection, throughput, and support. We'll even preconfigure custom or standard analyzers so they arrive at the lab ready-to-go. Agilent's expertise in both chemical analysis and life science is a powerful combination for researching and producing biofuels, including a wide range of analytical techniques for fatty acid methyl esters (FAMES). Our newly-expanded portfolio also offers powerful tools for developing and producing photovoltaic films and solar panels.



Forensics

Because the careers of world class athletes and many other individuals hinge on drug testing, it's critical that those doing the testing have the highest level of confidence in the results. Forensics analysts worldwide have grown to depend on Agilent tools for accuracy, reliability, and speed in this high stakes, high-throughput field. Our best selling GC, GC/MS and popular LC and LC/MS are workhorses in forensics labs.

Traditional Lab Informatics

The ways labs generate and store data profoundly affect their efficiency. Agilent offers a rich, integrated suite of software products built on a set of customer-driven architectural values with the Agilent OpenLAB Laboratory Software Suite. OpenLAB delivers superior performance, open systems integration and investment protection. Our commitment is to deliver more value across each step in the life cycle of scientific data – from data collection and analysis to interpretation and management.

Materials Science

Agilent offers a newly expanded portfolio of instruments used for the research, manufacturing and testing of advanced materials, from precision optics to pulp, paper and polymers. Tools for chromatography, atomic absorption spectroscopy, molecular spectroscopy, X-ray crystallography, and nuclear magnetic resonance all support continuous progress in materials science.



Biopharmaceutical

As "multi-omics" studies gain momentum in the search for new therapeutics, Agilent is uniquely positioned to provide the instruments, reagents, and powerful software needed for performing experiments in multiple disciplines and combining the massive amounts of data into biological insight.



Pharmaceutical

Drug manufacturing requires the accuracy, sensitivity and high throughput of other analytical applications, along with the demands of regulatory record-keeping and validation requirements. Agilent provides a potent combination of rugged, high-throughput tools and unmatched compliance services. Agilent now offers the market-leading family of dissolution apparatus and sampling systems that pair perfectly with our HPLC and UV systems.



Proteomics

Research into how large sets of proteins affect the health of an organism requires special sets of analytical tools. Agilent has built a formidable arsenal of liquid chromatograph/mass spectrometers, bioinformatics systems, multiple affinity protein removal columns, and OFFGEL electrophoresis for protein identification and protein biomarker discovery. Accurate-Mass mass spectrometry and the microfluidic HPLC-Chip/MS are two Agilent innovations speeding the work of proteomics researchers around the globe.



Metabolomics

Collections of small molecules are increasingly being seen as rich sources of biomarkers, but studying metabolites presents many challenges. The need for speed, accuracy, and powerful interpretation capabilities in looking at chemical profile snapshots is underscored because molecules are constantly entering, leaving or changing within the metabolome. Agilent's GC, LC, NMR and MS portfolios, along with our excellent bioinformatics offerings, user-customizable METLIN metabolite database for LC/MS, and the industry's first commercial GC/MS retention time locked metabolite library align well with needs of metabolomics researchers.



Genomics

Agilent is a global leader in microarrays, scanners, and reagents used in a wide variety of genomic-based disease research experiments. Our SureSelect Target Enrichment System dominates the category, streamlining next generation sequencing studies worldwide. Agilent offers a wide range of catalog microarrays and a highly-developed capability to produce custom arrays featuring ink jet-based SurePrint fabrication and the eArray on-line design tool. All Agilent microarrays feature highly sensitive, selective 60-mer probes. With as many as eight arrays printed on a standard 1 x 3 in. slide, the cost per experiment becomes very affordable.

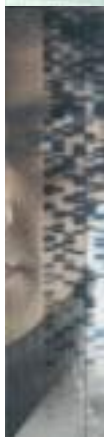

Life Science Informatics

Mirroring its extensive instrument portfolio, Agilent offers the industry's most extensive suite of bioinformatics software, helping users derive knowledge from complex genomic, proteomic, metabolomic and other biological data. This includes DNA Analytics for analyzing CGH, ChIP and methylation microarray data. The GeneSpring suite includes informatics software for microarray-based gene expression data, genotyping data, and GeneSpring MS, which are useful for analyzing mass spec data from proteomics and metabolomics experiments and comparing complex datasets to explore biological questions from multiple perspectives.



Lab Automation

To meet the skyrocketing demand for more throughput and automation, Agilent has substantially expanded its lab automation offerings. The Agilent line of liquid handlers and microplate processors are designed to streamline high-volume life science workflows. Agilent is also continually upgrading its advanced autosamplers for LC, GC, LC/MS and GC/MS, adding functionality and speed to reflect the performance of its advanced instruments.



Vacuum Technology

Agilent works with customers to solve vacuum challenges from experiments in high-energy physics to developing systems for producing flat panel displays. Agilent manufactures vacuum systems used in its own mass spectrometry instruments as well as those of other manufacturers. Agilent's vacuum technology has been proven by the most powerful physics experiment ever built, CERN's Large Hadron Collider machine, which was used in the discovery of the Higgs boson particle.



Get the Agilent Service Guarantee

Should your instrument require service while covered by an Agilent service agreement, we guarantee repair or we will replace your instrument for free.

No other company offers this level of commitment to keep your lab up and running at peak efficiency.



Laboratory decision makers and users ranked Agilent as their first choice for general laboratory compliance services.

Agilent Service and Support for Instrument Systems

Focus on what you do best

For over 40 years, Agilent has been building and maintaining the instruments you count on to stay competitive and successful. Trust us to protect your investment with a broad portfolio of services, backed by a global network of experienced service professionals dedicated to the productivity of your lab.

Agilent Advantage Service Plans

The best service available for your Agilent instruments

Agilent offers a flexible range of service plans so that you can choose the level of coverage that is best for your lab.

- **Agilent Advantage Gold** – Priority-one coverage for ultimate uptime and productivity
- **Agilent Advantage Silver** – Comprehensive coverage for dependable laboratory operations
- **Agilent Advantage Bronze** – Total repair coverage at a fixed annual price
- **Agilent Repair Service** – Basic coverage for reliable instrument repair

Agilent Advantage service plans include Agilent Remote Advisor for real-time remote monitoring and diagnostics. Through secure internet connections, you can interact with Agilent service professionals, receive detailed asset reports, and configure text or email alerts to notify you before problems occur – helping you to maximize instrument uptime and optimize laboratory workflows.

Agilent Compliance Services

Equipment qualification that meets the most stringent requirements

Enterprise Edition Compliance was developed to streamline compliance across your entire lab. Used globally in regulated labs, including standards organizations and regulatory agencies, Enterprise Edition enables you to:

- Improve qualification efficiency by automating protocols across platforms to ensure greater efficiency and minimize regulatory risk
- Standardize your entire compliance operation with robust test designs that work with all your instruments
- Add, remove or reconfigure tests based upon your unique user requirements
- Significantly reduce staff review time with consistently formatted, computer generated, tamper-proof reports

Agilent Education and Consulting Services

Our best minds, working for you

Make the most of your instrument with training and consulting from the same experts who designed the instruments, software and processes you use every day.

- Classroom and on-site training in instrument operation, troubleshooting and maintenance
- Customized consulting services to meet your lab's unique needs

The Agilent Value Promise – 10 Years of Guaranteed Value

In addition to continually evolving products, we offer something else unique to the industry – our 10-year value guarantee. The Agilent Value Promise guarantees you at least 10 years of instrument use from your date of purchase, or we will credit you with the residual value of the system toward an upgraded model. Not only does Agilent ensure a reliable purchase now, but we also ensure that your investment is just as valuable in the future.

For more detailed information, please go to www.agilent.com/chem/services or contact your local Agilent Services and Support representative.

Technical Support at work for you

Have a hardware, software, application, instrument repair or troubleshooting question? Agilent's technical experts are available to answer your questions. With years of laboratory experience, our technical support specialists can provide in-depth knowledge and experience.

For questions pertaining to supplies found in this catalog, contact your local Agilent office or Authorized Agilent Distributor or visit www.agilent.com/chem/techsupport



Need more information?

Visit www.agilent.com/chem/contactus to:

- Locate your nearest Agilent office or distributor for expert technical support.
- Get fast sales and product assistance by phone. Simply use the scroll-down menu to select your country.
- Receive email assistance using our convenient online forms.



Agilent Gas Clean Filters

The Agilent Gas Clean Filter System provides enhanced gas quality for maximum productivity. Clean gases reduce the risk of column damage, sensitivity loss, and instrument downtime. Oxygen, hydrocarbons and moisture can cause loss of sensitivity and accuracy of the GC, and damage your column and consumables. Inserting a Gas Clean Filter System in the gas line immediately before the instrument inlet greatly reduces the level of impurities and helps you detect any problems before they occur.

Turn to pages 96-99.

Agilent Ultra Inert Solutions

Agilent is leading the way in flow path inertness with their industry-leading Agilent J&W Ultra Inert GC Column family and the Agilent Ultra Inert Liner. Whether you are analyzing difficult, active food and environmental samples or screening for drugs of abuse, our Ultra Inert solutions help ensure an inert GC flow path for higher sensitivity, accuracy, and reproducibility...especially at trace levels. For more information, visit www.agilent.com/chem/ultraintert



Agilent Electronic Crimper and Decapper

The Agilent Electronic Crimper and Decapper is much easier to use than a manual crimper, and is more likely to give you a secure seal every time. The crimper also increases lab productivity because you don't waste time refixing poor seals and cleaning up broken glass and spilled samples. You can also be confident that you do not risk losing potentially valuable samples.

Turn to page 34.

Agilent Syringes

Whether you need an autosampler or manual syringe, there are two key features consider when choosing the right syringe – identifying your sample type and establishing the smallest volume to be dispensed or injected. Agilent offers syringes for all sample types in all the dimensions you are ever likely to need, for accurate and effective sampling.

Turn to page 60.



Agilent CrossLab

Agilent CrossLab Supplies

Agilent CrossLab is a growing portfolio of GC and LC supplies critical to instrument performance and productivity. They are manufactured to perform seamlessly with a variety of analytical instruments in your lab, regardless of make or model. When you choose Agilent CrossLab, you know you'll get:

- Over 40 years of chromatography expertise and on-going innovation
- The same commitment to quality inherent in all Agilent products
- Optimal performance for routine and challenging applications
- Convenience of consolidated purchasing

All with our risk-free, 90-day, money-back guarantee.



Agilent CrossLab HPLC supports instruments from Waters, Shimadzu, Dionex (now part of Thermo Scientific), CTC Analytics, and more. The comprehensive range includes detector lamps, autosampler vials and closures, well plates and sealing mats, autosampler syringes, pump and valve supplies, capillaries, tubing, and fittings, and performance maintenance kits. Put Agilent CrossLab HPLC quality supplies to work across your lab.

Agilent CrossLab GC works with instruments from Bruker (formerly Varian), CTC Analytics, PerkinElmer, and Shimadzu, with more on the way. The family comprises autosampler syringes to autosampler vials, Agilent Ultra Inert inlet liners to non-stick liner O-rings, capillary column ferrules to column nuts, vials, caps, septa, and more. Experience the same Agilent quality solutions you know and trust, now for your non-Agilent GCs.



All Agilent Crosslab high quality supplies are backed by Agilent's worldwide technical support and dependable availability and delivery.

For information on Agilent CrossLab Vials, turn to page 36

For information on Agilent CrossLab Syringes, turn to page 77-78



Agilent Vials and Closures

Common questions about Agilent vials and caps

Why is it important to use Agilent Certified vials on my Agilent autosampler?

Agilent Certified vials are the only vials in the industry designed and tested for full compatibility with our autosamplers. The same attention and precision that go into designing our instruments, columns, and parts also go into designing these vials. Many Agilent autosamplers use a robotic arm to grip vials by the neck. Therefore, it is critical that the vial neck and shoulder are the proper height to prevent dropped vials and lost samples. Only Agilent Certified vials are designed for use on Agilent autosamplers; competitor products simply do not meet our exact specifications, which can lead to costly instrument downtime and potential loss of your precious samples.

Is the same true for Agilent Certified caps and inserts?

To avoid leakage and sample loss due to evaporation, inserts must sit neatly in the vial – and the entire assembly must be tightly sealed when capped. You should also consider the depth of your autosampler needle when using an insert to prevent needle damage and ensure proper sample uptake.

The threads on the Agilent Certified screw vials are designed precisely to match the threads on Agilent Certified caps. Using a non-Agilent Certified cap on these vials will not create a secure, tight seal and will lead to sample loss. In addition, Certified crimp vials and caps are tested over 100,000 times on our Agilent autosamplers to confirm a proper fit and secure seal.

Do I need to be concerned about the compatibility of my sample with my vials?

For highly sensitive samples such as pesticides or semivolatiles, as well as samples that are prone to sudden shifts in pH, deactivated vials are best, because their surface is more hydrophobic and inert. For more exacting, demanding applications, such as mass spectrometry, deactivated vials are recommended to prevent sample interactions prior to analysis.

Polypropylene vials are an excellent choice for biological applications and for applications involving samples with high metal content, such as ion chromatography, AA, or ICP-MS. Agilent thoroughly tested and evaluated a variety of polypropylene materials prior to selecting the grade used in our polypropylene vials. Our polypropylene vials have the lowest levels of extractables to ensure integrity of your sample.

Can I count on consistency from one vial to the next?

Autosampler vials can vary from their stated size and wall weight if tolerances are not tightly controlled. This can affect the volume of sample in the vial, which is especially problematic when working with small amounts of sample. Our tight control of tolerances extends through the entire manufacturing process, from the initial design to the final opto-electronic screening process, which inspects every single vial and cap for accuracy.

Agilent Certified vials conform to the industry’s tightest tolerances to ensure consistency from lot to lot, as well as from one vial to the next.

Why should I buy my vials from Agilent?

Vial integrity, cleanliness, and consistency are critical for today’s demanding applications. That is why Agilent vials and caps are designed using the same engineering expertise that is built into Agilent instruments. All Agilent Certified vials are manufactured in ISO 9001 clean environments, must pass a 33-point visual inspection, and are uniquely packaged to stay clean and secure during shipment.

Why It Is Critical to Use Agilent Certified Vials and Closures on Agilent Autosamplers

Common Problems	Effects	Benefits of Agilent Certified Vials and Caps
Inconsistency with vial bottom thickness	<ul style="list-style-type: none"> • Sample draw inconsistency • Damaged needle 	Consistent and valid relative standard deviation (RSD) values
Autosampler sequence interruption	<ul style="list-style-type: none"> • Mishandled or dropped vials • Loss of precious sample 	Confidence in unattended operation
Undetected improper seal	<ul style="list-style-type: none"> • Sample loss/evaporation • Possible sample contamination 	Proper sealing for accurate results
Dislodged or misaligned septa	<ul style="list-style-type: none"> • Sample loss • Sample contamination 	Accurate results
Ghost peaks	<ul style="list-style-type: none"> • Contamination by cap septa 	Chromatographic purity test that eliminates outliers and analysis errors

TIPS & TOOLS

Agilent has made vial, cap and septum selection easy with its new Interactive Vial Selection Tool, available online in both desktop and mobile versions. The tool identifies the right vial and closures for your particular application, and provides the rationale for the choices offered.

Visit www.agilent.com/chem/SelectVials



Protect sample integrity by choosing the right septa for your application

Proper septa selection is critical to preventing contamination and avoiding damage to the needle and instrument. Here are some questions you should ask:

Are the septa chemically compatible with your samples and solvents?

The chart below summarizes chemical compatibility and incompatibility. Agilent provides this septa compatibility as a guide and a starting reference point. We realize that chemical compatibility can vary depending on the concentration of the solvent, the temperature, the molecular weight of the solvent, and other factors. Therefore it is always recommended you try a variety of septa to determine the best one for your analysis.

Septa Chemical Compatibility						
	PTFE	PTFE/Silicone	PTFE/Silicone/PTFE*	PTFE/Red Rubber	Viton	PTFE/Butyl
Acetonitrile	✓	✓	✓	✓		✓
Hydrocarbons (hexane, heptane, methane)	✓		✓	✓	✓	
Methanol	✓	✓	✓	✓		✓
Benzene	✓		✓		✓	
THF	✓		✓			
Toluene	✓		✓			
DMF	✓	✓	✓			✓
DMSO	✓	✓	✓			✓
Ether	✓	✓	✓			
Chlorinated Solvents (methylene chloride)	✓		✓		✓	
Alcohols (ethanol)	✓	✓	✓	✓	✓	✓
Acetic Acid	✓	✓	✓			✓
Acetone	✓	✓	✓			
Phenol	✓	✓	✓		✓	✓
Cyclohexane	✓		✓	✓	✓	

*PTFE/silicone/PTFE has the same chemical compatibility of PTFE ONLY UNTIL PUNCTURED

Will my application require repeat injections from the same vial or storage of the sample?

Resealability is an important factor to consider when selecting septa. PTFE/red rubber septa are not recommended for multiple injections or for samples that need to be stored for further analysis. When applications require a longer time between injections or any type of standard additions, PTFE/silicone/PTFE septa are always best.

What force is required to penetrate the septa?

Generally, silicone septa are more easily pierced than red rubber or butyl septa. For thicker, hard-to-pierce septa, a small gauge (23 gauge) needle may be required. Or an S-needle as they are stronger.

Pre-slit septa are the best option for the easiest penetration and will reduce the likelihood of coring.

All Agilent Certified septa are designed for optimal use with Agilent autosamplers and for proper fit in the caps.

Cap and Septa Compatibility

	High Performance Septa	Thin PTFE	PTFE/Silicone*	PTFE/Silicone/PTFE*	PTFE/Red Rubber	Viton	Butyl
Temperature range	40 °C to 300 °C**	Up to 260 °C	-40 °C to 200 °C	-40 °C to 200 °C	-40 °C to 90 °C	-40 °C to 260 °C	-50 °C to 150 °C
Use for multiple injections	No	No	Yes	Yes	No	No	No
Price	More expensive	Very economical	Economical	Most expensive	Very economical	Economical	Economical
Resistance to coring	Excellent	None	Excellent	Excellent	None	None	None
Recommended for storage	No	No	Yes	Yes	No	No	No
Best for	High temperature headspace applications	Superior chemical inertness, short cycle times, and single injections	Most common HPLC and GC analyses, not as resistant to coring as P/S/P	Superior performance for ultra trace analysis, repeat injections, internal standards	Chlorosilanes, more economical option for single injections	Chlorinated solvents, higher temperatures	Organic solvents, acetic acids; impermeable to gases

*Agilent silicone is platinum cured (versus peroxide cured), making it more inert and less likely to interact with samples

**For up to one hour

TIPS & TOOLS

Agilent has made vial, cap and septum selection easy with its new Interactive Vial Selection Tool, available online in both desktop and mobile versions. The tool identifies the right vial and closures for your particular application, and provides the rationale for the choices offered.

Visit www.agilent.com/chem/SelectVials



What temperature range does my application require?

Septa can degrade at higher temperatures, causing contamination of your samples. Red rubber septa are only stable up to 90 °C and therefore are not a good option for higher temperature applications. Generally, PTFE-lined silicone septa provide the best compatibility with a wide range of temperatures.

For newer headspace applications that require temperatures up to 300 °C, Agilent offers the new High Performance Septa, made of special proprietary materials that minimize degradation at extreme temperatures.

How do I avoid common issues caused by septa?

Coring

Coring occurs when the needle diameter is too large for the septa or when the septa material is not durable enough to withstand repeat injections. When this happens, septa material can flake off into the vial and contaminate the sample. Here is how to prevent coring:

- Choose a PTFE-lined septum to prevent septa material from entering the sample
- Make sure the needle is not damaged, and consider a side-entry needle instead of a conical needle
- Use pre-slit septa, which will virtually eliminate coring

Vacuum Generation

Sometimes withdrawing volume from a sealed vial can create a vacuum. A few simple steps can prevent this from happening:

- Use pre-slit septa to help equalize the pressure on both sides of the cap
- Do not overfill vials
- Do not take more than 50 µL (from a 2 mL vial) in one injection

TIPS & TOOLS



For highly sensitive samples, we recommend PTFE-lined ("sandwiched") septa, because the PTFE layers act as a chemically resistant barrier.

TIPS & TOOLS



Septa that are too thick can prevent the cap from fitting properly on the vial. Agilent Certified septa are designed for use in our Certified caps.

Agilent Vial Identification Chart and Actual Fill Volumes

Wide Opening Screw Top Vials (9 mm)

Narrow Opening Screw Top Vials (8 mm)

Polypropylene Vials

Crimp/Snap Top

Screw Top

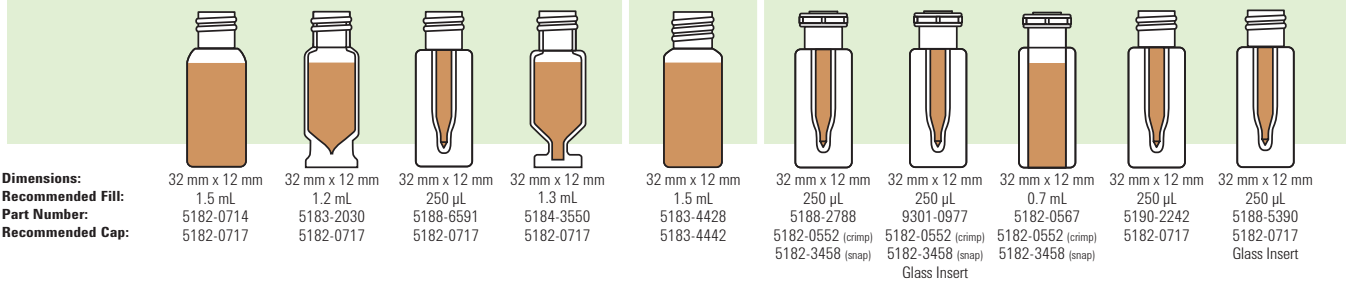

Wide Opening Crimp Top Vials (11 mm)

Wide Opening Snap Top Vials

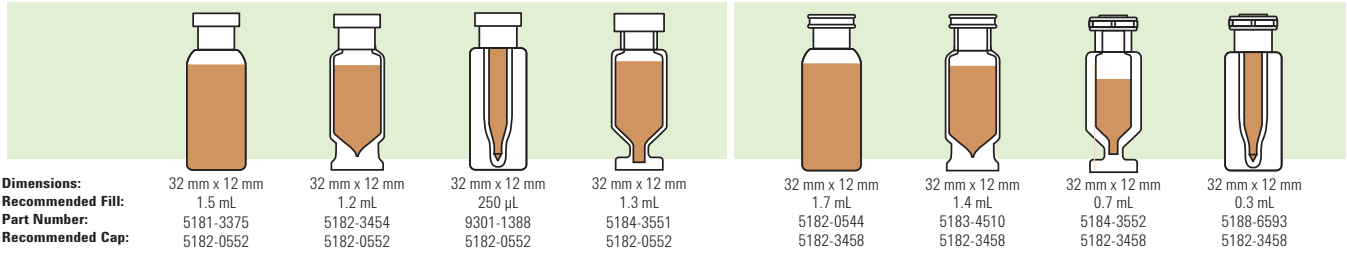

Inserts for Wide Opening Vials (11 mm & 9 mm)

Inserts for Narrow Opening Vials (8 mm)

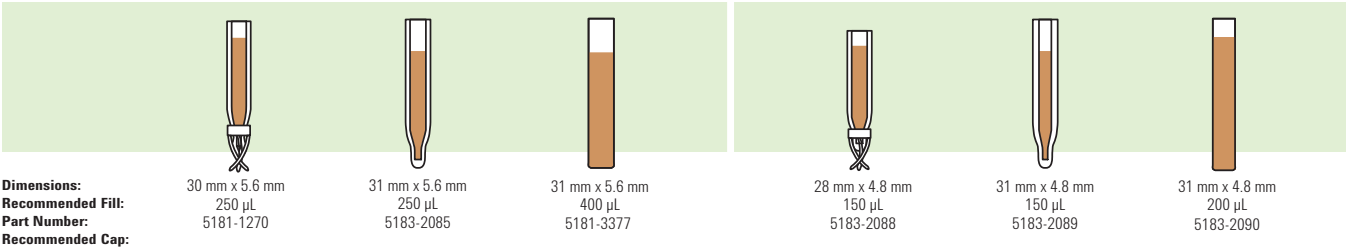

Headspace Vials

Mini Vials

Specialty Vials

Large Volume Vials

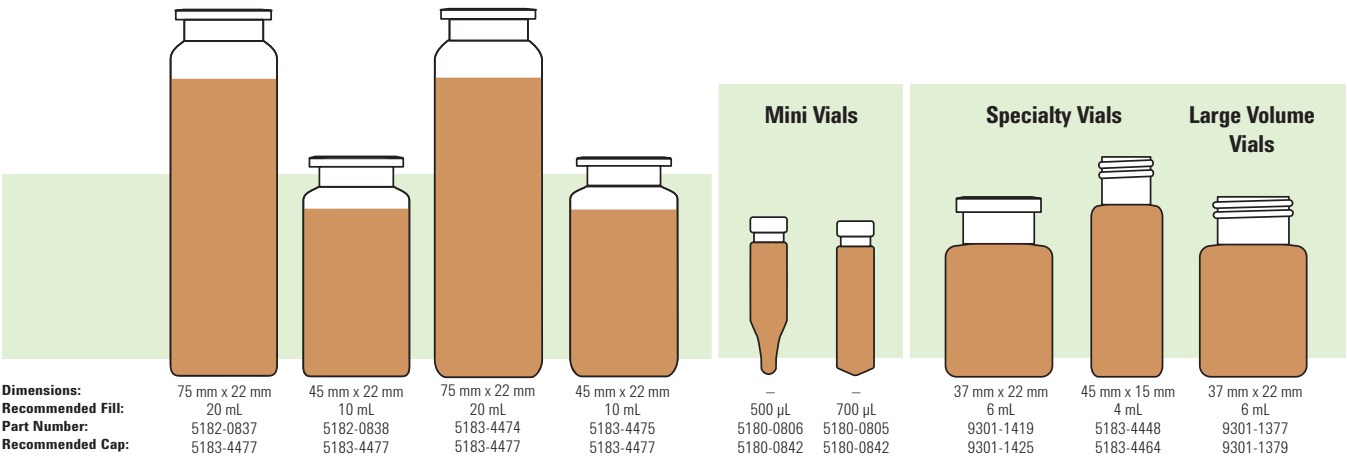

MS Analyzed Vial Kits

Agilent MS Analyzed Vial Kits end the need to pre-test or to re-run samples due to unexpected peaks. All MS Analyzed Vial Kits include a Certificate of Analysis that contains accurate, lot-specific, and fully traceable LC/MS and GC/MS signal traces, as well as critical physical dimensions. Agilent's new MS Analyzed Vial Kits provide lot-specific test results for greater confidence in your results.



- All vials are lot-tested by both GC/MS and LC/MS using Agilent systems
- Manufactured for full-warranted compatibility with Agilent GC and LC autosamplers
- Packaged in a unique box designed to reduce vial breakage
- Packed in a clean environment using clean packaging to reduce contamination
- Available in both crimp top and screw top closures
- Larger write-on spots for easier labeling and identification
- Conveniently packaged in a combination pack with 100 vials and 100 caps/septa



Screw top MS analyzed vial kit, 5190-2277



Screw top MS analyzed vial kit, 5190-2280



Crimp top MS analyzed vial kit, 5190-2282

MS Analyzed Vial Kits

Vial Type	Septa Type	Cap Color	100/pk
Screw Top MS Analyzed Vial Kits			
Clear	PTFE/red silicone septa	Blue	5190-2277
Clear with write-on spot	PTFE/red silicone septa	Blue	5190-2278
Amber	PTFE/red silicone septa	Blue	5190-2279
Amber with write-on spot	PTFE/red silicone septa	Blue	5190-2280
Crimp Top MS Analyzed Vial Kits			
Clear	PTFE/white silicone septa	Silver aluminum	5190-2281
Clear with write-on spot	PTFE/white silicone septa	Silver aluminum	5190-2282
Amber	PTFE/white silicone septa	Silver aluminum	5190-2283



Certificate of Analysis
signed by Agilent's Quality Manager

Certified Screw Top Vials and Closures

Combine the excellent autosampler handling of a crimp cap profile with the ease of a screw cap. The screw caps and precision fit septa give a secure seal with microvolume inserts.

- Certified for full warranted compatibility with Agilent autosamplers
- 2 mL, 12 x 32 mm, 9 mm diameter
- Packaged in a unique box designed to reduce vial breakage
- 40% larger opening than standard narrow opening vials
- Unique thread design for consistently secure seal
- Precision-formed neck for optimal robotic arm handling
- Rigorous quality assurance for dimensional consistency from lot-to-lot
- Optional ceramic write-on spot with fill marks



2 mL Wide Opening Screw Top Glass Vials

Description	100/pk	1000/cs*
Clear	5182-0714	5183-2067
Clear, write-on spot	5182-0715	5183-2068
Amber	5188-6535	5188-6536
Amber, write-on spot	5182-0716	5183-2069
Deactivated Vials		
Clear	5183-2070	
Clear, write-on spot	5183-2071	
Amber, write-on spot	5183-2072	

*Case includes 10 packs of 100 vials

LC Vials and Closures

Description	Unit	Part No.
6 mL Screw Top Vials and Closures		
Clear, flat bottom	100/pk	9301-1377
Screw caps, 16 mm	100/pk	9301-1379
PTFE/silicone septa	100/pk	9301-1378
PTFE/silicone septa, pre-slit	100/pk	5188-2758
5 mL Screw Top Vials		
Clear, high recovery	30/pk	5188-5369



PTFE-lined solid top screw caps for 2 mL vials, 5183-2075



Polypropylene caps with bonded septa, 5185-5823



Screw caps with septa

Screw Caps for 2 mL Vials

Color	Septa Type	Certified	100/pk	500/pk	1000/pk
Blue	PTFE/red silicone septa	✓	5182-0717	5185-5820	5190-1599
	PTFE/white silicone septa	✓	5182-0720	5185-5863	
	PTFE/silicone/PTFE septa	✓	5182-0723	5185-5862	
	Pre-slit PTFE/silicone septa	✓	5183-2076	5185-5865	
	PTFE-lined solid top	✓	5183-2075		
	Open top, no septa	✓	5182-0728		
	Bonded PTFE/silicone septa		5185-5823		
	Bonded pre-slit PTFE/silicone septa		5185-5824	5040-4649	
Green	PTFE/red silicone septa	✓	5182-0718	5185-5829	
	PTFE/white silicone septa	✓	5182-0721	5185-5864	
	PTFE/silicone/PTFE septa	✓	5182-0724	5185-5861	
	Pre-slit PTFE/silicone septa	✓	5183-2077		
	Open top, no septa	✓	5182-0727		
Red	PTFE/red silicone septa	✓	5182-0719		
	PTFE/white silicone septa	✓	5182-0722		
	PTFE/silicone/PTFE septa	✓	5182-0725		
	Pre-slit PTFE/silicone septa	✓	5183-2078		
	Open top, no septa	✓	5182-0726		
Black	PTFE/red silicone septa	✓	5185-5838		
Purple	PTFE/silicone septa	✓	5040-4681		
Light turquoise	PTFE/silicone septa	✓	5040-4683		

Certified Septa for Wide Opening (9 mm) Screw Caps

Septa Type	Color	100/pk
PTFE/red silicone	Ivory	5182-0731
PTFE/white silicone/red PTFE	Red	5182-0729
Pre-slit PTFE/white silicone	Blue	5183-2074
PTFE/white silicone	Red	5182-0730

Screw Cap Pack for 7696 Sample Prep Workbench

Description	Septa Type	Part No.
Multicolor screw cap pack Includes 50/pk of each color: blue, green, red, light turquoise, purple	PTFE/silicone septa	5040-4682

Certified 2 mL Screw Top Vial Packs

Pre-assembled packs come ready-to-use with the cap and septum of your choice attached to the vial. A time- and labor-saving product for use with your Agilent autosampler or any rotating tray automatic sampler.

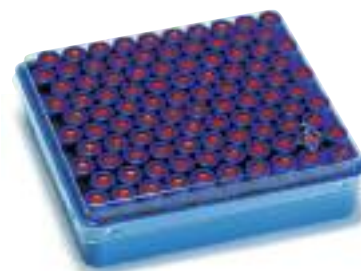

Pre-assembled vial pack

Certified 2 mL Screw Top Vial Packs

Vial Type	Septa Type	Cap Color	100/pk
Clear	PTFE/red silicone septa	Blue	5182-0553
Clear with write-on spot	PTFE/red silicone septa	Blue	5182-0864
Amber with write-on spot	PTFE/red silicone septa	Green	5182-0554
Clear	PTFE/silicone/PTFE septa	Blue	5182-0555
Clear with write-on spot	PTFE/silicone/PTFE septa	Blue	5182-0866
Amber with write-on spot	PTFE/silicone/PTFE septa	Green	5182-0556
Clear	PTFE/silicone septa	Blue	5182-0557
Clear with write-on spot	PTFE/silicone septa	Blue	5182-0865
Amber with write-on spot	PTFE/silicone septa	Green	5182-0558
Clear	Pre-slit PTFE/silicone septa	Blue	5183-2082
Clear with write-on spot	Pre-slit PTFE/silicone septa	Blue	5183-2083



Screw top vial convenience kit

Certified Screw Top Vial Convenience Packs

Convenience packs are an easy way to get 500 of each component using one part number. Packed in our six-drawer, reusable blue plastic cabinet, 500 vials and caps with septa installed are kept handy and dust-free.

Certified Screw Top Vial Convenience Packs

Vial Type	Septa Type	Cap Color	500/pk
Clear	PTFE/red silicone septa	Blue	5182-0732
Clear with write-on spot	PTFE/red silicone septa	Blue	5182-0867
Amber with write-on spot	PTFE/red silicone septa	Green	5182-0733
Clear	PTFE/silicone/PTFE septa	Blue	5182-0736
Clear with write-on spot	PTFE/silicone/PTFE septa	Blue	5182-0869
Amber with write-on spot	PTFE/silicone/PTFE septa	Green	5182-0737
Clear	PTFE/silicone septa	Blue	5182-0734
Clear with write-on spot	PTFE/silicone septa	Blue	5182-0868
Amber with write-on spot	PTFE/silicone septa	Green	5182-0735
Clear	Pre-slit PTFE/silicone septa	Blue	5183-2079
Clear with write-on spot	Pre-slit PTFE/silicone septa	Blue	5183-2080
Amber with write-on spot	Pre-slit PTFE/silicone septa	Green	5183-2081
Clear	Bonded, pre-slit PTFE/silicone septa	Blue	5067-0205

Crimp Top Vials and Closures

The wide opening crimp cap provides a larger target area for improved autosampler needle accuracy. Select from five cap colors and a variety of septa. Whatever your crimp top vial needs, Agilent has what you are looking for.

- Certified for full warranted compatibility with Agilent autosamplers
- 2 mL, 12 x 32 mm
- Available in unique packaging designed to reduce vial breakage
- Tightly controlled crown for improved crimping
- Precision-formed neck for improved autosampler handling
- Rigorous quality assurance provides dimensional consistency from lot-to-lot
- Optional ceramic write-on spot with fill marks



2 mL Wide Opening Crimp Top Vials

Description	Certified	100/pk	1000/cs*
Clear	✓	5181-3375	5183-4491
Clear, write-on spot	✓	5182-0543	5183-4492
Amber, write-on spot	✓	5181-3376	5183-4493
Deactivated Vials			
Clear	✓	5183-4494	
Clear, write-on spot	✓	5183-4495	
Amber, write-on spot	✓	5183-4496	
Crimp Top Vials with Fixed Inserts			
Amber, 300 µL recommended useable volume		5188-6572	
Clear, 300 µL recommended useable volume		9301-1388	

*Case includes 10 packs of 100 vials



Clear crimp top vials, 5181-3375

LC Vials and Closures

Description	Unit	Part No.
6 mL Crimp Top Vials and Closures		
Clear, flat bottom	100/pk	9301-1419
Crimp caps, 20 mm, PTFE/silicone septa	100/pk	9301-1425



Magnetic crimp caps, 5188-5386

Crimp Caps with 11 mm Septa

Agilent recommends using Certified crimp caps with PTFE/silicone septa to ensure seamless operation with your Agilent autosampler. Agilent Certified crimp caps are guaranteed to work with your instrument to reduce autosampler malfunctioning and contamination.

Crimp Caps with 11 mm Septa

Cap Color	Septa Type	Certified	25/pk	100/pk	500/pk	1000/pk
Silver aluminum	PTFE/silicone/ PTFE septa	✓		5181-1211		5183-4499
	PTFE/silicone septa	✓		5182-0552		5183-4500
	Black Viton septa	✓		5181-1212		
	Thin PTFE septa	✓		5182-0871		
	Thin-membrane rubber septa		5062-3582			
	PTFE/red rubber septa			5181-1210	5061-3370	5183-4498
Blue aluminum	PTFE/red rubber septa			5181-1215		
Green aluminum	PTFE/red rubber septa			5181-1216		
Red aluminum	PTFE/red rubber septa			5181-1217		
Gold aluminum	Magnetic			5188-5386		

Crimp Top Vial Convenience Packs

Vial Type	Septa Type	Cap Color	500/pk
Clear	PTFE/red rubber septa	Silver aluminum	5181-3400
Clear with write-on spot	PTFE/red rubber septa	Silver aluminum	5190-2241
Amber with write-on spot	PTFE/red rubber septa	Silver aluminum	5181-8801

TIPS & TOOLS



Red rubber septa have a tendency to cause needle sticking during sampling. Agilent recommends a 23/26 gauge needle when using red rubber septa. Agilent Certified crimp caps are compatible with all needle types.

Certified Microvolume Inserts for Wide Opening Vials

To meet your microsampling needs, Agilent has a variety of microvolume inserts with capacities and designs that can transform our vials from full-capacity to limited volume with one simple step. Microvolume inserts are certified to work with all Certified vials for excellent fit with Agilent autosamplers.

Certified Microvolume Inserts for Wide Opening Vials

Description	Maximum Fill Volume	Recommended Fill Volume	Unit	Part No.
Conical Inserts with Polymer Feet				
Glass inserts with polymer feet and mandrel interior	320 µL	250 µL	100/pk	5181-1270*
Deactivated glass inserts with polymer feet and mandrel interior	350 µL	250 µL	100/pk	5181-8872
Conical Glass Inserts				
Pulled-point glass inserts	350 µL	250 µL	100/pk	5183-2085
Pulled-point glass inserts	180 µL	100 µL	500/pk	9301-1387
Flat Bottom Inserts				
Glass flat bottom inserts	440 µL	400 µL	500/pk	5181-3377
Deactivated glass flat bottom inserts	440 µL	400 µL	500/pk	5183-2086

*For vortexing or mixing small volume samples, Agilent recommends using 5181-1270 because it provides a secure seal with the cap and septum



250 µL pulled-point glass inserts, 5183-2085



400 µL glass flat bottom inserts, 5181-3377

Polypropylene Vials

Wide opening 12 x 32 mm vials are manufactured from virgin polypropylene, meeting the requirements of 21 CFR 177.1520. Polypropylene is chemically resistant and the material of choice for sodium or heavy metals analysis. Polypropylene vials are translucent and can be used with crimp caps.

Agilent's polypropylene vials use the purest, cleanest grade of polypropylene available, to guarantee the lowest levels of extractables. In addition, the walls of these vials have been thickened to withstand the force of Agilent LC and CE autosamplers. Competitor vials are not comparable.



Crimp/Snap top polypropylene vial, 250 µL, 5188-2788



Polypropylene vial with glass insert, 9301-0977

When should I use a Polypropylene Vial?

The information provided below will help you to determine if polypropylene vials or silanized glass vials are the best option for your application. As always, this information serves only as a guideline, and we always recommend testing options before deciding on the proper vial and cap.

Polypropylene

- Traditionally the material of choice for LC or LC/MS and CE
- Polypropylene can oxidize some biologicals
- Not recommended for light sensitive compounds
- Not compatible with a number of organic solvents
- Max temperature of ~ 175 °C

Available Sizes/Formats

Polypropylene Vials

250 µL	Crimp & Screw
--------	---------------

Deactivated/Silanized Vials

2 mL	Crimp, Snap & Screw
250 µL, 400 µL	Microvolume Inserts

TIPS & TOOLS



The Agilent headspace autosamplers G1888A, and 7694A, B and E are compatible with the flat bottom headspace vials only. Only Agilent vials are designed to properly fit in the Agilent autosampler incubator.

Deactivated/Silanized Vials

- Deactivation process renders surface inert
- Will not interact with metals, biologicals or proteins and will not cause shifts in pH of sample
- Compatible with a wide variety of solvents
- Available in amber for light sensitive samples
- More expensive than polypropylene
- Can withstand temperatures up to 500 °C

Agilent Polypropylene Vial Compatibility

Contact Time	Extraction (<5 min)	< 1 hr	1 - 4 hr	4 - 8 hr	24 hr
Hexane	Good	Fair	Not recommended	Not recommended	Not recommended
THF	Good	Fair	Not recommended	Not recommended	Not recommended
MeCl ₂	Good	Fair	Not recommended	Not recommended	Not recommended
Toluene	Good	Fair	Not recommended	Not recommended	Not recommended
Isooctane	Good	Good	Fair	Fair	Not recommended
Acetone	Good	Good	Good	Fair	Not recommended
Ethyl acetate	Good	Good	Good	Fair	Fair
IPA	Good	Good	Good	Good	Good
Ethanol	Good	Good	Good	Good	Good
Methanol	Good	Good	Good	Good	Good
DMSO	Good	Good	Good	Good	Good
Acetonitrile	Good	Good	Good	Good	Good

Polypropylene Vials

Vial Type	Volume	Certified	100/pk	1000/pk
Polypropylene, crimp/snap top	250 µL	✓	5188-2788	9301-0978
Polypropylene, screw top	250 µL	✓	5190-2242	5190-2243
Polypropylene, crimp/snap top	250 µL			5190-3155
Polypropylene, crimp/snap top	1 mL		5182-0567	
Polypropylene with glass insert, crimp/snap top	250 µL		9301-0977	
Polypropylene with glass insert, screw top	250 µL		5188-5390	



Headspace Vials and Closures

Beveled-neck headspace vials are available in both 10 mL and 20 mL capacities, flat or rounded bottom. The 20 mm crimp caps provide a consistently secure seal. Agilent also offers cost-saving convenience packs with vials, caps and septa packaged together.

- Certified for full warranted compatibility with Agilent autosamplers
- Choice of crimp or screw top vials
- Beveled top for maximum secure seal
- Two neck lengths available
- Choice of a pressure safety release cap at 45 psi
- Available in flat or rounded bottom designs



Clear headspace crimp top vials with graduation marks and write-on spot, 5190-2285



Amber headspace crimp top vials with graduation marks and write-on spot, 5190-2288

Certified Headspace Crimp Top Glass Vials

Description	Unit	Flat Bottom	Rounded Bottom
10 mL, 23 x 46 mm			
Clear	100/pk	5182-0838	5183-4475
Amber	100/pk	5067-0227	5190-2238
Clear, graduation marks and write-on spot	100/pk	5190-2285	
Amber, graduation marks and write-on spot	100/pk	5190-2287	
20 mL, 23 x 75 mm			
Clear	100/pk	5182-0837	5183-4474
Amber	100/pk	5067-0226	5190-2239
Clear, graduation marks and write-on spot	100/pk	5190-2286	
Amber, graduation marks and write-on spot	100/pk	5190-2288	

High Performance Septa

Agilent introduces the first septa that can withstand extreme temperatures and conditions for today's demanding headspace applications.

- Proven to withstand temperatures up to 300 °C with no degradation
- Leakproof
- Available in your choice of crimp or screw

Headspace screw top vial blank chromatogram comparison at 300 °C with different septa

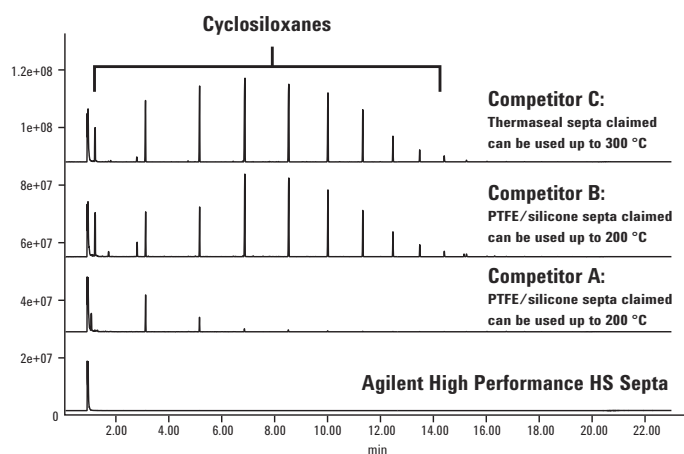

GC/MS conditions

Inlet:	Split mode w/ 10:1 ratio, 250 °C
Column:	DB-5ms Ultra Inert, 30 m x 0.25 mm, 0.25 µm, Constant flow: 2.5 mL/min
Oven:	40 °C hold 1.5 min, then 15 °C/min to 325 °C and hold for 2.5 min, 23 min total run time
Thermal Aux/MS source/MS guard:	250 °C/230 °C/150 °C
MSD:	Scan mode 25 - 550 m/z

Vial blank sample chromatogram at 300 °C with Agilent High Performance HS Septa

Agilent High Performance Septa provide significant cleaner blank background at high temperature HS testing. Even with small abundance scale, the 300 °C vial blank chromatogram with High Performance Septa only shows few siloxane peaks with very small abundance.

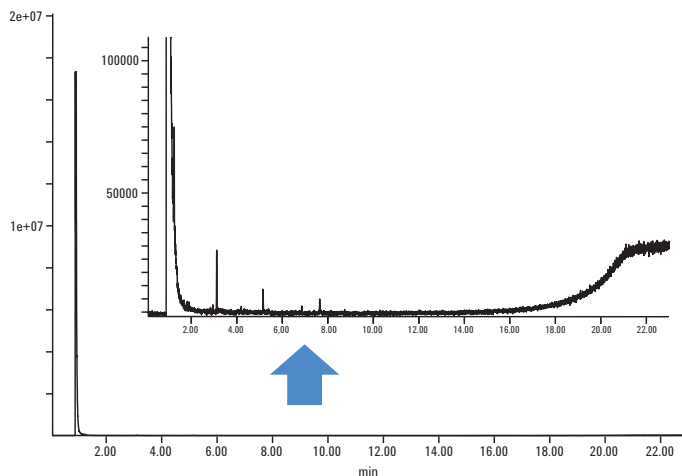

Headspace conditions

Septa Type:	Agilent High Performance Septa, 5190-3986
Temperature:	Oven/loop & valve/transfer line: 300 °C/300 °C/300 °C
Times:	GC cycle time: 32 min, Vial equilib time: 30 min
Vial:	Fill pressure: 15 psi, Fill flow: 50 mL/min, Loop fill ramp rate: 20 psi/min, Loop final pressure: 10 psi, Vial Size: 20 mL, Shaking: 1
Carrier:	GC controlled

TIPS & TOOLS



For information on CrossLab High Performance Septa, turn to page 41-42.

High Performance Septa

Description	Unit	Agilent Certified Part No.	Compatible With
18 mm steel screw cap with High Performance Septa	100/pk	5190-3986	5188-2753, 5188-6537, 5188-5392, 5188-6538
20 mm steel crimp cap with High Performance Septa	100/pk	5190-3987	5182-0837, 5183-4474, 5067-0226, 5190-2239, 5182-0838, 5183-4475, 5067-0227, 5190-2238

20 mm Headspace Crimp Caps and Septa

Cap Color	Septa Type	Specifications	Certified	100/pk	10,000/pk
Silver aluminum	PTFE/silicone septa	-60 °C to 180 °C	✓	5183-4477	5190-2257
Silver aluminum with safety feature	PTFE/silicone septa	-60 °C to 180 °C	✓	5183-4478	
Silver aluminum	Molded PTFE/ butyl septa	-40 °C to 125 °C	✓	5183-4479	5190-2258
Silver aluminum with safety feature	Molded PTFE/ butyl septa	-40 °C to 125 °C		5183-4480	
Silver aluminum	No septa			9301-0721	
Silver aluminum with safety feature	No septa			9301-0718	
Septa only	Gray PTFE/ black butyl molded	-40 °C to 125 °C		9301-0976	
Septa only	Tan PTFE/ white silicone	-60 °C to 180 °C		9301-0719	5067-0234



Aluminum crimp caps, 5183-4477



Headspace vial convenience kit

Certified Headspace Vial Convenience Packs

Septa Type	Vial Type	Cap Color	Specifications	Unit	Part No.
Molded PTFE/ black butyl septa	Flat bottom	Silver aluminum with safety feature	< 125 °C	100/pk	5182-0839
PTFE/silicone septa	Flat bottom	Silver aluminum with safety feature	< 180 °C	100/pk	5182-0840

TIPS & TOOLS



For information on CrossLab Headspace Vial Convenience Packs, turn to pages 40-42.

CombiPAL Headspace Vials and Closures

Screw top vials and caps are recommended for the tightest seal and the most reproducible headspace results. CombiPAL headspace vials and caps are precision-threaded, making them an excellent choice for dependability and ease-of-use. They are ideal for applications in the environmental, food and beverage, industrial hygiene, drug analysis, and clinical chemistry industries.

CombiPAL Headspace Screw Top Vials

Description	100/pk
10 mL, 23 x 46 mm	
Clear	5188-5392
Amber	5188-6538
20 mL, 23 x 75 mm	
Clear	5188-2753
Amber	5188-6537

CombiPAL 18 mm Screw Top Caps with Septa

Cap Color	Septa Type	100/pk
Silver aluminum, magnetic	PTFE/silicone septa (top white, bottom blue)	5188-2759





Snap Top Vials and Closures

Snap top vials and caps are the simple, efficient way to a secure seal without crimping. It's as easy as push-on, pull-off. Crimp caps can also be used with wide opening snap top vials. **Note:** Snap cap vials cannot be pressurized.

- 2 mL, 12 x 32 mm
- Use with any 11 mm snap or crimp cap
- Available in unique packaging designed to reduce vial breakage
- Provides a total seal around the entire circumference of the vial crown
- Precision-formed neck improves autosampler handling
- Optional ceramic write-on spot
- Uniformly flat bottom ensures compatibility with inserts



Snap top vials with fixed inserts

2 mL (11 mm) Snap Top Glass Vials

Description	100/pk	1000/cs*
Clear	5182-0544	5183-4504
Clear, write-on spot	5182-0546	5183-4505
Amber, write-on spot	5182-0545	5183-4506
Deactivated Vials		
Clear	5183-4507	
Clear, write-on spot	5183-4508	
Amber, write-on spot	5183-4509	
Snap Top Vials with Fixed Inserts		
Clear, 300 µL useable volume	5188-6593	
Amber, 300 µL useable volume	5188-6594	

*Case includes 10 packs of 100 vials

Polyethylene Snap Caps with 11 mm Septa

Cap Color	Septa Type	100/pk	500/pk
Clear	Clear PTFE/red silicone septa	5182-0550	5182-0564
Blue	Clear PTFE/red silicone septa	5182-3458	
Green	Clear PTFE/red silicone septa	5182-3457	
Red	Clear PTFE/red silicone septa	5182-3459	
Clear	PTFE/silicone/PTFE septa	5182-0566	
Blue	PTFE/silicone septa	5182-0541	
Clear	Pre-slit PTFE/silicone septa	5183-4511	
Clear	Solid polyethylene membrane septa	5182-0542	
Clear	PTFE septa	5182-0540	



Snap caps with septa

Snap Top Vial Convenience Packs

Vial Type	Septa Type	Cap Color	500/pk
Clear	PTFE/red rubber septa	Clear polypropylene	5182-0547
Clear with write-on spot	PTFE/red rubber septa	Clear polypropylene	5190-2240
Amber	PTFE/red rubber septa	Clear polypropylene	5182-0548



Crimp top vial, high recovery, 5182-3454

Specialty Vials and Closures

High Recovery Glass Vials

Wide opening, 1.5 mL vials with 30 μ L reservoir are for sample concentration and injection without transferring to microvolume inserts.

1.5 mL Wide Opening High Recovery Glass Vials

Vial Type	Unit	Screw Top	Crimp Top	Snap Top
Clear	100/pk	5183-2030	5182-3454	5183-4510
Clear, silanized	100/pk		5183-4497	
Amber	100/pk	5183-2073		



Micro-V Vial, snap top, 5184-3552

Micro-V Vials

- Wide opening, 1.5 mL vials with low residual volume
- Made from first hydrolytical glass Type 1
- Standard 12 x 32 mm dimension
- Compatible with 11 mm crimp closures
- Lower cost alternative to high recovery vials

Micro-V Vials

Description	Unit	Screw Top	Crimp Top	Snap Top
Clear	100/pk	5184-3550	5184-3551	5184-3552
Amber	100/pk	5184-3554	5184-3555	5184-3556

Standard Opening Screw Top Vials, Closures and Inserts

The original, smaller opening vials with an 8-425 thread-size screw cap are available with black caps and a variety of septa to meet the needs of your application.

- 2 mL, 12 x 32 mm, 8 mm diameter
- 8-425 thread design
- Original, standard neck size



Screw top vials, closures and inserts

2 mL Standard Opening (8 mm) Screw Top Glass Vials

Description	Unit	Part No.
Clear	100/pk	5183-4428
Amber	100/pk	5183-4429
Clear, PTFE-lined storage cap	100/pk	5183-4518
Deactivated Vials		
Clear	100/pk	5183-4432
Amber	100/pk	5183-4433

Screw Caps and Septa for Standard Opening (8 mm) Vials

Cap Color	Septa Type	Unit	Part No.
Black	Red PTFE/white silicone	100/pk	5183-4442
Black	No septa	100/pk	5183-4438
Septa only	Red PTFE/white silicone/red PTFE, 8 mm	100/pk	5183-4436
Septa only	Red PTFE/white silicone, 8 mm	100/pk	5183-4437
Septa only	PTFE-coated butyl rubber	500/pk	9301-1130



8-425 screw top vials

Microvolume Inserts for Standard Opening (8 mm) Vials

Description	Unit	Part No.
Conical Inserts with Polymer Feet		
150 μ L glass inserts with polymer feet	100/pk	5183-2088
Conical Glass Inserts		
150 μ L pulled-point interior glass inserts	100/pk	5183-2089
Flat Bottom Inserts		
200 μ L glass flat bottom inserts	100/pk	5183-2090



4 mL (13 mm) Screw Top Vials and Closures

- 4 mL, 15 x 45 mm
- Precision-formed screw threads (13 x 425) for consistently secure seal
- Can be used as wash, waste, or storage vials

4 mL (13 mm) Screw Top Glass Vials

Description	Unit	Part No.
Clear	100/pk	5183-4448
Clear with write-on spot	100/pk	5067-0246
Amber	100/pk	5183-4450
Amber with write-on spot	100/pk	5067-0247



Caps and Septa for 4 mL (13 mm) Vials

Description	Unit	Part No.
Black 13 x 425 caps, PTFE/silicone septa	100/pk	5183-4464
Black 13 x 425 open top screw caps	100/pk	5183-4461
Diffusion inserts used with black open top screw caps	12/pk	07673-40180
PTFE/natural rubber septa	144/pk	9301-1031
Red PTFE/white silicone septa	100/pk	5183-4460
White virgin PTFE septa	1000/pk	5183-4459

4 mL (13 mm) Screw Top Convenience Packs

Description	Unit	Part No.
Clear vials with caps (no septa)	144/pk	9301-0723
4 mL wash vials with fill markings and caps	25/pk	5182-0551

General Purpose Sample Storage Vial and Caps

Agilent caps and vials are ideal for sampling and storage. Caps are lined with PTFE/silicone for excellent sealability and chemical resistance. All caps include bonded septa that will prevent liner fallout during shipping and sampling. Caps are manufactured of high quality materials to eliminate sample contamination.



Sample vial pack

General Purpose Sample Storage Vial Kits

Vial Size	Cap Size	Vial Type	Unit	Closed Top	Open Top
4 mL, 15 x 45	13-425	Clear	100/pk	5183-4311	5183-4331
		Amber	100/pk	5183-4321	
12 mL, 19 x 65	15-425	Clear	100/pk	5183-4312	5183-4332
		Amber	100/pk	5183-4322	
22 mL, 23 x 85	20-400	Clear	100/pk	5183-4313	5183-4333
		Amber	100/pk	5183-4323	
40 mL, 28 x 95	24-414	Clear	100/pk	5183-4314	5183-4334
		Amber	100/pk	5183-4324	

Bonded Caps

Cap Size	Cap Color	Cap Type	Septa Type	Unit	Closed Top	Open Top
13-425	White	Polypropylene	PTFE/silicone liner	100/pk	5183-4301	5183-4305
15-425	White	Polypropylene	PTFE/silicone liner	100/pk	5183-4302	5183-4306
20-400	White	Polypropylene	PTFE/silicone liner	100/pk	5183-4303	5183-4307
24-414	White	Polypropylene	PTFE/silicone liner	100/pk	5183-4304	5183-4308



Sample storage vial kit, 5183-4324

Crimping and Decapping Tools

Electronic Crimpers and Decappers

Designed to replace awkward and bulky manual crimping pliers, the Agilent electronic handheld crimpers give tight, reproducible seals every time. Adjustable, slim steel jaws fit around closely spaced vials, enabling you to crimp vials directly in crowded autosampler trays. Using the same handheld design as the crimpers, Agilent's electronic decappers remove caps instantly and are designed for laboratories that recycle or reuse vials.

- More vials crimped per battery charge – new lithium ion battery lasts three times longer
- Increased crimping speed – new model is 50% more powerful (6.4 volt battery)
- Less hand strain – lighter weight means less effort
- Improved power signal – clearly shows when battery needs recharging
- Easily used in right or left hand – display on top for easier viewing
- More efficient charging – no overheating during recharging
- Extended productivity – significantly longer motor life



11 mm electronic crimper, 5190-3188



20 mm electronic crimper, 5190-3189



11 mm electronic decapper, 5190-3190



20 mm electronic decapper, 5190-3191

Electronic Crimpers and Decappers

Description	Part No.
11 mm electronic crimper with lithium battery	5190-3188
20 mm electronic crimper with lithium battery	5190-3189
11 mm electronic decapper with lithium battery	5190-3190
20 mm electronic decapper with lithium battery	5190-3191
Replacement lithium battery for crimper and decapper	5190-3192
High Power Electronic Crimping Tool with Power Supply	5190-4061
11 mm Crimper Jaw Set for HP Electronic Crimper	5190-4062
11 mm Decapper Jaw Set for HP Electronic Crimp tool	5190-4063
20 mm Crimper Jaw Set	5190-4064
20 mm Decapper Jaw Set	5190-4065
Base for Electronic Crimping Tool	5190-4066
20 mm HP Crimping Tool and Jaw Sets Bundle	5190-4067

Manual Crimpers and Decappers

Agilent's ergonomic manual crimpers and decappers remove the pain and discomfort of wrist strain with a lightweight, tailored design. Weighing 25-30% less than predecessors and eliminating sore, pinched hands, the new design dramatically improves your experience. Extensively tested with Agilent vials for optimal fit, and color-coded for ease-of-use, this tool is a necessity for every lab. The new crimpers are built for lasting performance: the 11 mm crimper will cap at least 100,000 caps and the 20 mm at least 60,000 before wear starts to impact performance.

- Comfortable, lightweight, ergonomically designed handles fit smoothly in the hand and eliminate pinching
- Top-mounted adjustment knob shows directionality for tightening/loosening
- Adjustment knob doubles as an indicator that the crimp (or decap) is complete
- Crimpers are color-coded with blue knobs and labels, decappers with orange
- Narrow jaws provide better vertical clearance over vials
- Bottom handle motion allows for better control and enhanced stability of crimping jaw
- Sturdy construction of rugged, fiber-reinforced resin with steel reinforcement in the handles



Manual Crimpers and Decappers

Description	Part No.
Ergonomic manual crimper for 11 mm caps	5040-4667
Ergonomic manual decapper for 11 mm caps	5040-4668
Ergonomic manual crimper for 20 mm caps	5040-4669
Ergonomic manual decapper for 20 mm caps	5040-4671



Ergonomic manual crimper, 5040-4667

CrossLab Vials and Closures

Agilent CrossLab vials and closures are thoroughly tested to ensure the highest level of quality. Additionally, CrossLab vials are designed for use in a wide range of non-Agilent GCs and LCs, including those from Bruker (formerly Varian), Dionex (now Thermo Scientific), PerkinElmer, Shimadzu, and Thermo Scientific. They are:

- Manufactured in an ISO 9001 certified facility
- Made from First Hydrolytic Type 1 Class A or Class B borosilicate glass, which conforms to US FDA, USP, and EU Pharmacopeia standards
- Protected by proprietary packaging with a crush barrier to reduce vial breakage
- Packaged in material that has been tested and selected for cleanliness
- Subjected to rigorous end-of-line sampling and quality control procedures to ensure all vials remain within specifications
- Compatible with a wide variety of autosamplers regardless of make and model



CrossLab Vials and Closures







The table below illustrates that the Agilent CrossLab vial portfolio is compatible with a wide range of HPLC and GC autosamplers.





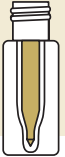



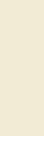

CrossLab Vial Compatibility						
Manufacturer	Autosampler	8 mm Screw Top	9 mm Screw Top	15 x 45 mm, 4 mL	11 mm Crimp Top	Headspace
Waters	717 Plus				✓	
	Acquity	✓	✓		✓	
	Alliance 2690	✓	✓			
	CapLC	✓	✓		✓	
	WISP			✓		
Shimadzu	AOC14/1400	✓	✓		✓	
	AOC-20		✓	✓	✓	
	AOC 88/9	✓	✓		✓	
	AOC-5000	✓	✓		✓	Magnetic
	HSS-2B/4B					✓
	LC 2010	✓	✓		✓	
	SIL-6A/6B/9A	With flange				
	SIL-10A, SIL-10Ai, SIL-10AxL	✓	✓			
	SIL-HT/10ADVP	✓	✓		✓	
Thermo Scientific	A-200S/AS 150/800/8000	✓	✓		✓	
	AS 3000/TRACE GC		✓		✓	
	ASI-100	✓	✓		✓	
	SURVEYOR LC	✓	✓		✓	
	TriPlus		✓		✓	
	WPS-3000RS	✓	✓		✓	
	WPS-3000SL	✓	✓		✓	
	Bruker, Varian*	8034/8035/8100/8200	✓	✓		✓
9095/9100		✓	✓		✓	
CP-8410			✓	✓	✓	
Genesis						✓
PerkinElmer	Autosystem GC/XL/AS-2000	✓	✓	✓	✓	
	Clarus 500/600		✓		✓	
	HS16/40					✓
	Integral 4000	✓	✓		✓	
	ISS-100/200	✓	✓		✓	
	LC 600 42 vial tray		✓			
	LC Plus	✓	✓	✓		
	TurboMatrix 40/110					✓
CTC Analytics	CombiPal		✓	✓	✓	Magnetic

*Formerly Varian systems, now Bruker products







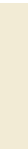

Agilent CrossLab Vial Identification Chart with Recommended Fill Volumes

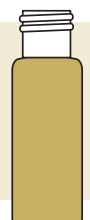
The Agilent CrossLab vial identification chart below provides a quick reference on vial dimensions, fill volumes, and Agilent CrossLab part numbers for a variety of vials, along with the recommended closures, for both HPLC and GC autosamplers.

	Wide Opening Screw Top Vials (9 mm)			Narrow Opening Screw Top Vials (8 mm)		Wide Opening Crimp Top Vials (11 mm)		
								
Dimensions:	32 mm x 12 mm	32 mm x 12 mm	32 mm x 12 mm	32 mm x 12 mm	32 mm x 12 mm	32 mm x 12 mm	32 mm x 12 mm	32 mm x 12 mm
Recommended Fill:	1.7 mL	1.3 mL	0.3 mL	1.5 mL	1.7 mL	1.3 mL	0.3 mL	0.3 mL
Part Number:	8010-0014	8010-0018	8010-0008	8010-0010	8010-0001	8010-0004	8010-0006	8010-0006
Recommended Cap*:	8010-0086	8010-0086	8010-0086	8010-0061	8010-0050	8010-0050	8010-0050	8010-0050

	Wide Opening Snap Top Vials		Micro Vials			Polypropylene Vials Crimp/Snap Top		Polypropylene Vials Screw Top			
											
Dimensions:	32 mm x 12 mm	32 mm x 12 mm	40 mm x 7 mm	32 mm x 5.5 mm	32 mm x 5.5 mm	32 mm x 12 mm	32 mm x 12 mm	32 mm x 12 mm	32 mm x 12 mm	32 mm x 12 mm	32 mm x 12 mm
Recommended Fill:	1.5 mL	1.3 mL	0.8 mL	0.1 mL	250 µL	250 µL	250 µL	0.7 mL	250 µL	250 µL	250 µL
Part Number:	8010-0023	8010-0028	8010-0153	8010-0154	8010-0155	8010-0158	8010-0160	8010-0159	8010-0161	8010-0086	8010-0162
Recommended Cap*:	8010-0108	8010-0108	8010-0516	8010-0516	8010-0516	8010-0050	8010-0050	8010-0050	8010-0086	8010-0086	8010-0086
							Glass Insert				Glass Insert

	Headspace Vials						
							
Dimensions:	45 mm x 22 mm	45 mm x 22 mm	75 mm x 22 mm	75 mm x 22 mm	75 mm x 22 mm	45 mm x 22 mm	75 mm x 22 mm
Recommended Fill:	10 mL	10 mL	20 mL	20 mL	20 mL	10 mL	20 mL
Part Number:	8010-0029	8010-0030	8010-0033	8010-0034	8010-0152	8010-0038	8010-0042
Recommended Cap*:	8010-0116	8010-0116	8010-0116	8010-0116	8010-0116	8010-0139	8010-0139

	Specialty Vials			Inserts for Wide Opening Vials (11 mm & 9 mm)			Inserts for Narrow Opening Vials (8 mm)		
									
Dimensions:	37 mm x 22 mm	45 mm x 15 mm	37 mm x 22 mm	30 mm x 5.6 mm	31 mm x 5.6 mm	31 mm x 5.6 mm	28 mm x 4.8 mm	31 mm x 4.8 mm	31 mm x 4.8 mm
Recommended Fill:	6 mL	4 mL	6 mL	250 µL	250 µL	400 µL	150 µL	150 µL	200 µL
Part Number:	8010-0151	8010-0020	8010-0022	8010-0131	8010-0132	8010-0136	8010-0124	8010-0125	8010-0126
Recommended Cap*:	8010-0116	8010-0095	8010-0101						

*Caps are available in a variety of colors

Vial Septum Chemical Compatibility Chart

	PTFE	PTFE/Silicone	PTFE/ Silicone/ PTFE*	PTFE/ Red Rubber	Viton	PTFE/Butyl
Acetonitrile	✓	✓	✓	✓		✓
Hydrocarbons (hexane, heptane, methane)	✓		✓	✓	✓	
Methanol	✓	✓	✓	✓		✓
Benzene	✓		✓		✓	
THF	✓		✓			
Toluene	✓		✓			
DMF	✓	✓	✓			✓
DMSO	✓	✓	✓			✓
Ether	✓	✓	✓			
Chlorinated Solvents (methylene chloride)	✓		✓		✓	
Alcohols (ethanol)	✓	✓	✓	✓	✓	✓
Acetic Acid	✓	✓	✓			✓
Acetone	✓	✓	✓			
Phenol	✓	✓	✓		✓	✓
Cyclohexane	✓		✓	✓	✓	

*PTFE/silicone/PTFE has the same chemical compatibility of PTFE ONLY UNTIL PUNCTURED

Agilent provides this septa compatibility information as a guide and starting reference point. We realize that chemical compatibility can vary depending on the concentration of the solvent, temperature, molecular weight of the solvent, and other factors. Therefore, it is always recommended that you try a variety of septa to determine the best one for your analysis.

Vial Cap and Septum Compatibility

	Thin PTFE	PTFE/ Silicone*	PTFE/ Silicone/ PTFE*	PTFE/ Red Rubber	Viton	Butyl	High Performance Septa
Temperature range	Up to 260 °C	-40 °C to 200 °C	-40 °C to 200 °C	-40 °C to 90 °C	-40 °C to 260 °C	-50 °C to 150 °C	Up to 300 °C for up to 1 hour
Use for multiple injections	No	Yes	Yes	No	No	No	Yes
Price	Very economical	Economical	Most expensive	Very economical	Economical	Economical	More expensive
Resistance to coring	None	Excellent	Excellent	None	None	None	Excellent
Recommended for storage	No	Yes	Yes	No	No	No	No
Best for	Superior chemical inertness, short cycle times, and single injections	Most common HPLC and GC analyses, not as resistant to coring as P/S/P	Superior performance for ultra trace analysis, repeat injections, internal standards	Chlorosilanes, more economical option for single injections	Chlorinated solvents, higher temperatures	Organic solvents, acetic acids; impermeable to gases	High temperature headspace applications

*Agilent CrossLab silicone is platinum cured (versus peroxide cured), making it more inert and less likely to interact with samples

To obtain an optimal fit and seal of any vial and closure, we strongly recommend buying an entire CrossLab vial assembly (including a vial, cap, and septum, as well as a vial insert if needed). Please avoid mixing and matching any CrossLab vials with any other brand of closures, or any CrossLab closures with any other brand of vials.



Headspace crimp top vials, 8010-0029

CrossLab Headspace Vials and Closures

- Choice of crimp or screw top vials
- Bevelled top for maximum secure seal
- Choice of a pressure safety release cap at 45 psi
- Available in flat or rounded bottom designs
- New high performance septa designed for temperatures up to 300 °C

Headspace Crimp Top Glass Vials

Description	Unit	Flat Bottom CrossLab Part No.	Rounded Bottom CrossLab Part No.
10 mL Headspace Crimp Top Glass Vials			
Clear	100/pk	8010-0029	8010-0030
	1000/cs	8010-0179	
Amber, flat bottom	100/pk	8010-0031	8010-0032
20 mL Headspace Crimp Top Glass Vials			
Clear, flat bottom	100/pk	8010-0033	8010-0034
	1000/cs	8010-0180	
Amber, flat bottom	100/pk	8010-0035	8010-0036



Headspace crimp top glass vials, 8010-0033

Headspace Screw Top Glass Vials

Description	Unit	Rounded Bottom CrossLab Part No.
10 mL Headspace Screw Top Glass Vials		
Clear, flat bottom	100/pk	8010-0038
Amber, flat bottom	100/pk	8010-0040
20 mL Headspace Screw Top Glass Vials		
Clear, flat bottom	100/pk	8010-0042
Amber, flat bottom	100/pk	8010-0044

To obtain an optimal fit and seal of any vial and closure, we strongly recommend buying an entire CrossLab vial assembly (including a vial, cap, and septum, as well as a vial insert if needed). Please avoid mixing and matching any CrossLab vials with any other brand of closures, or any CrossLab closures with any other brand of vials.

22 mL Headspace Crimp Top Glass Vials

Description	Unit	Agilent CrossLab Part No.
Clear	100/pk	8010-0152

Use 20 mm crimp caps with 6 mL and 22 mL headspace vials

6 mL Headspace Crimp Top Glass Vials

Description	Unit	Agilent CrossLab Part No.
Clear	100/pk	8010-0151

Use 20 mm crimp caps with 6 mL headspace vials

TIPS & TOOLS

Many Agilent CrossLab vials are printed with graduation marks and write-on spots. Barcoding labels are also available for regular temperature and high temperature headspace applications.

**NEW! High Performance Septa**

The first septa that can withstand extreme temperatures and conditions for today's demanding headspace applications.

- Proven to withstand temperatures up to 300 °C for one hour with minimal degradation
- Leak proof
- Available in your choice of crimp or screw
- Compatible with all common headspace solvents including DMSO, DMF, Toluene, and Water
- Fits PerkinElmer and other headspace autosamplers



Headspace aluminum crimp caps with PTFE/silicone septa, 8010-0144

Headspace Caps and Septa

Cap Color	Septa Type	Unit	Agilent CrossLab Part No.
20 mm Headspace Crimp Caps and Septa			
Silver aluminum	Tan PTFE/silicone	100/pk	8010-0116
	Tan PTFE/silicone	1000/pk	8010-0191
	Gray PTFE/butyl	100/pk	8010-0117
	No septa	100/pk	8010-0120
Silver aluminum with safety feature	PTFE/butyl	100/pk	8010-0143
	PTFE/silicone	100/pk	8010-0144
Silver, magnetic	Tan PTFE/silicone	100/pk	8010-0165
Bimetal, magnetic	PTFE/silicone	100/pk	8010-0420
Steel	High performance	100/pk	8010-0429*
Steel, magnetic	PTFE/silicone	100/pk	8010-0424**
Septa only	Gray PTFE/butyl	100/pk	8010-0121
	Tan PTFE/silicone	100/pk	8010-0122
	PTFE/white silicone	1000/pk	8010-0192
18 mm Headspace Screw Caps and Septa			
Silver, magnetic	Tan PTFE/silicone	100/pk	8010-0119
	PTFE/silicone	100/pk	8010-0139***
	PTFE/butyl	100/pk	8010-0140
Steel	High performance	100/pk	8010-0428*
Septa only	Blue PTFE/silicone	1000/pk	8010-0418

*Recommended for high temperature applications up to 300 °C for up to one hour

**5.0 mm opening, suitable for SPME applications

***This cap is suitable for use in SPME applications

Headspace Vial Convenience Packs

Vial Type	Septa Type	Cap Color	Unit	Agilent CrossLab Part No.
10 mL, crimp top, clear, flat bottom	PTFE/silicone	Silver, aluminum	100/pk	8010-0412
20 mL, crimp top, clear, flat bottom	PTFE/silicone	Silver, aluminum	100/pk	8010-0413
20 mL, screw top, clear, rounded bottom	PTFE/silicone	Silver, magnetic	100/pk	8010-0417



TIPS & TOOLS

For further information on High Performance Septa, turn to pages 25-26.

CrossLab Screw Top Vials and Closures

Combine the excellent autosampler handling of a crimp cap profile with the ease of a screw cap. CrossLab screw caps and precision-fit septa give a secure seal with microvolume inserts.

2 mL Wide Opening (9 mm) Screw Top Vials and Closures

- 2 mL, 12 x 32 mm, 9 mm diameter
- Available in unique packaging designed to reduce vial breakage
- Wider opening prevents syringe problems
- Unique thread design for consistently secure seal
- Precision-formed neck for optimal robotic arm handling
- Optional ceramic write-on spot with fill marks

2 mL Wide Opening (9 mm) Screw Top Glass Vials

Description	Unit	Agilent CrossLab Part No.
Clear	100/pk	8010-0015
Clear, write-on spot	100/pk	8010-0014
	1000/cs	8010-0175
Amber	100/pk	8010-0017
Amber, write-on spot	100/pk	8010-0016
	1000/cs	8010-0176
Screw Top Vials with Fixed Inserts		
Clear, 300 μ L insert volume	100/pk	8010-0008
Amber, 300 μ L insert volume	100/pk	8010-0009



Clear, 2 mL wide opening (9 mm) screw top glass vials, 8010-0015



Wide opening screw top vials with write-on spot, 8010-0014

Screw Caps for Wide Opening (9 mm) Vials

Color	Septa Type	Unit	Agilent CrossLab Part No.
Blue	PTFE/silicone	100/pk	8010-0086
	PTFE/silicone/PTFE	100/pk	8010-0087
	Pre-slit PTFE/silicone	100/pk	8010-0078
	Bonded PTFE/silicone	100/pk	8010-0077
	PTFE lined	100/pk	8010-0080
	Open top, no septa	100/pk	8010-0079
Red	PTFE/silicone	100/pk	8010-0088
	PTFE/silicone/PTFE	100/pk	8010-0089
	Pre-slit PTFE/silicone	100/pk	8010-0082
	Bonded PTFE/silicone	100/pk	8010-0081
	Open top, no septa	100/pk	8010-0083
Orange	PTFE/silicone	100/pk	8010-0084
		1000/cs	8010-0186
	PTFE/silicone/PTFE	100/pk	8010-0085
		1000/cs	8010-0187
	Pre-slit PTFE/silicone	100/pk	8010-0075
	Bonded PTFE/silicone	100/pk	8010-0074
	Open top, no septa	100/pk	8010-0076



Orange screw caps with PTFE/silicone septa for wide opening (9 mm) vials, 8010-0084



Septa for wide opening screw caps, 8010-0094

Septa for Wide Opening (9 mm) Screw Caps

Septa Type	Color	Unit	Agilent CrossLab Part No.
PTFE/red silicone	Ivory	100/pk	8010-0093
PTFE/white silicone/red PTFE	Red	100/pk	8010-0091
		1000/cs	8010-0188
Pre-slit PTFE/white silicone	Blue	100/pk	8010-0094
PTFE/white silicone	Red	100/pk	8010-0092

2 mL Wide Opening (9 mm) Screw Top Vial Convenience Packs, 100/pk

Vial Type	Septa Type	Cap Color	Agilent CrossLab Part No.
Clear	Pre-slit PTFE/silicone	Red	8010-0425
Clear, write-on spot	PTFE/silicone	Orange	8010-0198
Clear, write-on spot	Pre-slit PTFE/silicone	Orange	8010-0542
Clear, write-on spot, 300 µL insert volume	PTFE/silicone	Orange	8010-0545
Clear, write-on spot, 300 µL insert volume	Pre-slit PTFE/silicone	Orange	8010-0547
Amber, write-on spot	PTFE/silicone	Orange	8010-0199
Amber, write-on spot	Pre-slit PTFE/silicone	Orange	8010-0543
Amber, write-on spot, 300 µL insert volume	PTFE/silicone	Orange	8010-0546
Amber, write-on spot, 300 µL insert volume	Pre-slit PTFE/silicone	Orange	8010-0548

2 mL Standard Opening (8 mm) Screw Top Vials and Closures

- 2 mL, 12 x 32 mm, 8 mm diameter
- 8-425 thread design
- Optional ceramic write-on spot with fill marks

2 mL Standard Opening (8 mm) Screw Top Glass Vials

Description	Unit	Agilent CrossLab Part No.
Clear	100/pk	8010-0011
Clear, write-on spot	100/pk	8010-0010
Amber	100/pk	8010-0013
Amber, write-on spot	100/pk	8010-0012



Clear 2 mL wide opening (8 mm) screw top glass vials, 8010-0011

2 mL Standard Opening (8 mm) Screw Top Glass Vial Convenience Packs

Vial Type	Septa Type	Cap Color	Unit	Agilent CrossLab Part No.
Clear	PTFE/silicone	Black	100/pk	8010-0414
Clear	PTFE/butyl	Black	100/pk	8010-0426
Clear, 100 µL insert volume	PTFE/butyl	Black	100/pk	8010-0427
Amber	PTFE/silicone	Black	100/pk	8010-0415

Screw Caps for Standard Opening (8 mm) Vials

Color	Septa Type	Unit	Agilent CrossLab Part No.
Blue	PTFE/silicone	100/pk	8010-0061
	Pre-slit PTFE/silicone	100/pk	8010-0062
	PTFE/silicone/PTFE	100/pk	8010-0063
	PTFE/butyl	100/pk	8010-0064
	Open top, no septa	100/pk	8010-0065
Red	PTFE/silicone	100/pk	8010-0066
	Pre-slit PTFE/silicone	100/pk	8010-0067
	PTFE/silicone/PTFE	100/pk	8010-0068
	PTFE/butyl	100/pk	8010-0069
	Open top, no septa	100/pk	8010-0070
Orange	PTFE/silicone	100/pk	8010-0056
	Pre-slit PTFE/silicone	100/pk	8010-0057
	PTFE/silicone/PTFE	100/pk	8010-0058
	PTFE/butyl	100/pk	8010-0059
	Open top, no septa	100/pk	8010-0060
Black	PTFE/silicone	100/pk	8010-0054
	Open top, no septa	100/pk	8010-0055



Screw caps for standard opening vials, 8010-0056

Flanged Caps (Compatible with Shimadzu Autosamplers)

Orange	Flanged, PTFE/silicone	100/pk	8010-0141
	Flanged, pre-slit PTFE/silicone	100/pk	8010-0142
	Flanged, no septa	100/pk	8010-0166

Septa for Standard Opening (8 mm) Vials

Septa Type	Unit	Agilent CrossLab Part No.
Red PTFE/white silicone/red PTFE	100/pk	8010-0071
Red PTFE/white silicone	100/pk	8010-0072
PTFE/butyl	500/pk	8010-0073

4 mL (13 mm) Screw Top Vials and Closures

- 4 mL, 15 x 45 mm
- Compatible with WISP 48 style autosamplers
- Precision-formed screw threads (13 x 425) for consistently secure seal
- Can be used as wash, waste, or storage vials



Black screw caps with red PTFE/silicone septa for 4 mL (13 mm) vials, 8010-0095

4 mL (13 mm) Screw Top Glass Vials

Description	Unit	Agilent CrossLab Part No.
Clear	100/pk	8010-0020
Amber	100/pk	8010-0021

Screw Caps for 4 mL (13 mm) Vials

Color	Septa Type	Unit	Agilent CrossLab Part No.
Black	Red PTFE/silicone	100/pk	8010-0095
	Open top, no septa	100/pk	8010-0096

Septa for 4 mL (13 mm) Vials

Septa Type	Unit	Agilent CrossLab Part No.
Red PTFE/white silicone	100/pk	8010-0098
White PTFE	100/pk	8010-0099
Pre-slit PTFE/silicone	100/pk	8010-0557

4 mL (13 mm) Screw Top Vial Convenience Packs, 100/pk

Vial Type	Septa Type	Cap Color	Agilent CrossLab Part No.
Clear	PTFE/silicone	Black	8010-0553
Clear	Pre-slit PTFE/silicone	Black	8010-0555
Clear, 250 µL insert volume	PTFE/silicone	Black	8010-0559
Clear, 250 µL insert volume	Pre-slit PTFE/silicone	Black	8010-0561
Amber	PTFE/silicone	Black	8010-0554
Amber	Pre-slit PTFE/silicone	Black	8010-0556
Amber, 250 µL insert volume	PTFE/silicone	Black	8010-0560
Amber, 250 µL insert volume	Pre-slit PTFE/silicone	Black	8010-0562



Screw caps for 6 mL (16 mm) vials

6 mL (16 mm) Screw Top Vials and Closures

6 mL (16 mm) Screw Top Glass Vials

Description	Unit	Agilent CrossLab Part No.
Clear	100/pk	8010-0022

Screw Caps for 6 mL (16 mm) Vials

Septa Type	Unit	Agilent CrossLab Part No.
PTFE/silicone	100/pk	8010-0101
Pre-slit PTFE/silicone	100/pk	8010-0102
Open top, no septa	100/pk	8010-0100

10 mL (22 mm) Screw Top Vials and Closures

10 mL (22 mm) Screw Top Glass Vials

Description	Unit	Agilent CrossLab Part No.
Clear	100/pk	8010-0563

Screw Caps for 10 mL (22 mm) Vials

Septa Type	Color	Unit	Agilent CrossLab Part No.
No septa	Black	100/pk	8010-0565

Septa for 10 mL (22 mm) Vials

Septa Type	Unit	Agilent CrossLab Part No.
PTFE/silicone	100/pk	8010-0564

CrossLab Crimp Top Vials and Closures

The wide opening crimp cap provides a larger target area for improved autosampler needle accuracy. Select from a variety of cap colors and septa. Whatever your crimp top vial needs, Agilent has what you are looking for.

2 mL (11 mm) Crimp Top Vials and Closures

- 2 mL, 12 x 32 mm
- Available in unique packaging designed to reduce vial breakage
- Tightly controlled crown for improved crimping
- Precision-formed neck for improved autosampler handling
- Rigorous quality assurance provides dimensional accuracy from lot to lot
- Optional ceramic write-on spot with fill marks



Crimp top glass vials with write-on spot, 8010-0001

2 mL (11 mm) Crimp Top Glass Vials

Description	Unit	Agilent CrossLab Part No.
Clear	100/pk	8010-0002
Clear, write-on spot	100/pk	8010-0001
	1000/cs	8010-0170
Amber, write-on spot	100/pk	8010-0003
	1000/cs	8010-0172
Crimp Top Vials with Fixed Inserts		
Clear, 300 µL insert volume	100/pk	8010-0006
Amber, 300 µL insert volume	100/pk	8010-0007

TIPS & TOOLS

Agilent offers ergonomic manual crimpers and decappers, designed to significantly reduce hand strain. Electronic versions are also available, featuring a longer life battery designed for quick, powerful use. For more information, please visit www.agilent.com/chem/crimper





Magnetic crimp caps, 8010-0052

Crimp Caps with 11 mm Septa

Cap Color	Septa Type	Unit	Agilent CrossLab Part No.
Silver aluminum	PTFE/silicone/PTFE	100/pk	8010-0049
		1000/cs	8010-0182
	PTFE/silicone	100/pk	8010-0050
		1000/cs	8010-0183
	Pre-slit PTFE/Silicone	100/pk	8010-0582
	PTFE/butyl	100/pk	8010-0051
	Thin membrane rubber	PTFE/red rubber	25/pk
100/pk			8010-0045
		1000/cs	8010-0181
Blue aluminum	PTFE/red rubber	100/pk	8010-0046
Green aluminum	PTFE/red rubber	100/pk	8010-0047
Red aluminum	PTFE/red rubber	100/pk	8010-0048
Gold aluminum	Magnetic	100/pk	8010-0052

2 mL (11 mm) Crimp Top Vial Convenience Packs, 100/pk

Vial Type	Septa Type	Cap Color	Agilent CrossLab Part No.
Clear, write-on spot	PTFE/silicone	Silver aluminum	8010-0195
Clear, write-on spot, 300 µL insert volume, conical with feet	PTFE/silicone	Silver aluminum	8010-0566
Clear, write-on spot, 300 µL insert volume, conical with feet	Pre-slit PTFE/silicone	Silver aluminum	8010-0568
Amber, write-on spot	PTFE/silicone	Silver aluminum	8010-0196
Amber, write-on spot, 300 µL insert volume, conical with feet	PTFE/silicone	Silver aluminum	8010-0567
Amber, write-on spot, 300 µL insert volume, conical with feet	Pre-slit PTFE/silicone	Silver aluminum	8010-0569

TIPS & TOOLS



Red rubber septa have a tendency to cause needle sticking during sampling and are more likely to core. Agilent recommends using silicone septa as a higher quality alternative to prevent contamination and issues related to septa coring.

Crimp Top Micro Vials

Agilent CrossLab offers a selection of crimp top micro vials designed for a variety of autosamplers, including HTS and HTC PAL systems, to cope with today's high-throughput LC/MS demands. Additionally, Agilent CrossLab crimp top micro vials work seamlessly with CombiPAL and GC PAL magnetic needle guides and barcode readers.

Crimp Top Micro Vials

Description	Volume	Unit	Agilent CrossLab Part No.
Amber, flat bottom	0.8 mL	1000/pk	8010-0153
Clear, tapered bottom	0.1 mL	500/pk	8010-0154
Clear, round bottom	0.3 mL	500/pk	8010-0155



Amber, flat bottom crimp top micro vials, 8010-0153

CrossLab Snap Top Vials and Closures

Snap top vials and caps are the simple, efficient way to a secure seal without crimping. It's as easy as push-on, pull-off. Crimp caps can also be used with wide opening snap top vials.

Note: Snap cap vials cannot be pressurized.

2 mL (11 mm) Snap Top Vials and Closures

- 2 mL, 12 x 32 mm
- Use with any 11 mm snap or crimp cap
- Available in unique packaging designed to reduce vial breakage
- Precision-formed neck improves autosampler handling
- Optional ceramic write-on spot

2 mL (11 mm) Snap Top Glass Vials

Description	Unit	Agilent CrossLab Part No.
Clear	100/pk	8010-0024
Clear, write-on spot	100/pk	8010-0023
	1000/cs	8010-0177
Amber	100/pk	8010-0026
Amber, write-on spot	100/pk	8010-0025
	1000/cs	8010-0178



Snap top vials with write-on spot, 8010-0025



Snap caps with 11 mm red silicone septa, 8010-0103

Snap Caps with 11 mm Septa

Cap Color	Septa Type	Unit	Agilent CrossLab Part No.
Clear	PTFE/red silicone	100/pk	8010-0104
	PTFE/silicone/PTFE	100/pk	8010-0105
	Pre-slit PTFE/white silicone	100/pk	8010-0106
	Clear polyethylene membrane	100/pk	8010-0107
Blue	PTFE/red silicone	100/pk	8010-0108
	PTFE/white silicone	100/pk	8010-0112
Green	PTFE/red silicone	100/pk	8010-0109
Orange	PTFE/red silicone	100/pk	8010-0103
	PTFE/red silicone	1000/cs	8010-0189
	PTFE/white silicone	100/pk	8010-0111
	Pre-slit PTFE/white silicone	1000/cs	8010-0190
	Pre-slit PTFE/white silicone	100/pk	8010-0113
Red	PTFE/red silicone	100/pk	8010-0110
Polyurethane		100/pk	8010-0115

2 mL (11 mm) Snap Top Vial Convenience Packs

Vial Type	Septa Type	Cap Color	Unit	Agilent CrossLab Part No.
Clear, write-on spot	PTFE/silicone	Orange	100/pk	8010-0200
Amber, write-on spot	PTFE/silicone	Orange	100/pk	8010-0411

Snap Top Solvent Vial Convenience Packs

Snap Top Solvent Vial Convenience Packs

Vial Type	Septa Type	Cap Color	Unit	Agilent CrossLab Part No.
5 mL Snap Top Solvent Vial Convenience Pack				
Clear	PTFE/silicone	Clear	100/pk	8010-0416
10 mL Snap Top Solvent Vial Convenience Pack				
Clear	Red PTFE/white silicone	Clear	100/pk	8010-0422

Snap Cap for 5 mL and 10 mL Solvent Vials

Cap Color	Septa Type	Unit	Agilent CrossLab Part No.
Clear	PTFE/silicone	50/pk	8010-0423

19 mm Septa for 5 mL and 10 mL Snap Caps

Septa Type	Unit	Agilent CrossLab Part No.
Red rubber	100/pk	8010-0430



CrossLab polypropylene vial, crimp/snap top, 8010-0158



Polypropylene vial with glass insert, 8010-0160

CrossLab Polypropylene Vials

Wide opening 12 x 32 mm vials are manufactured from virgin polypropylene, meeting the requirements of 21 CFR 177.1520. Polypropylene vials are translucent and can be used with crimp or snap caps.

Polypropylene Vials

Description	Recommended Fill Volume	Max Fill Volume	Unit	Agilent CrossLab Part No.
Polypropylene, crimp/snap top	250 µL	440 µL	100/pk	8010-0158
Polypropylene, crimp/snap top	250 µL	440 µL	1000/cs	8010-0193
Polypropylene, crimp/snap top	0.7 mL	1 mL	100/pk	8010-0159
Polypropylene, screw top	250 µL	440 µL	100/pk	8010-0161
Polypropylene, screw top	250 µL	440 µL	1000/cs	8010-0194
Polypropylene with glass insert, crimp/snap top	250 µL	350 µL	100/pk	8010-0160
Polypropylene with glass insert, screw top	250 µL	350 µL	100/pk	8010-0162



Clear, crimp top Micro-V vial, 8010-0004

CrossLab Micro-V Vials

- Wide opening, 1.5 mL vials with low residual volume
- Made from first hydrolytic glass Type 1
- Standard 12 x 32 mm dimension
- Compatible with 11 mm crimp closures

Micro-V Vials

Description	Unit	Screw Top	Crimp Top	Snap Top
Clear, screw top	100/pk	8010-0018	8010-0004	8010-0027
Amber	100/pk	8010-0019	8010-0005	8010-0028

TIPS & TOOLS



For economical and effective microsampling, choose the polypropylene vial with molded glass flanged insert. Its polypropylene body has a glass flanged insert molded to the inside, so the sample comes in contact only with the high quality glass insert and the septum.

CrossLab Microvolume Inserts

To meet your microsampling needs, Agilent offers a variety of microvolume inserts with capacities and designs that can transform your vials from full-capacity to limited volume with one simple step.

Microvolume Inserts for 8 mm Screw Top Vials

Description	Max Fill Volume	Recommended Fill Volume	Unit	Agilent CrossLab Part No.
Glass conical insert with polymer feet	200 µL	150 µL	100/pk	8010-0124
Glass pulled-point insert	200 µL	150 µL	100/pk	8010-0125
Flat bottom insert	250 µL	200 µL	100/pk	8010-0126

Microvolume Inserts for 11 mm Crimp Top or 9 mm Screw Top Vials

Description	Max Fill Volume	Recommended Fill Volume	Unit	Agilent CrossLab Part No.
Conical insert with polymer feet	350 µL	250 µL	100/pk	8010-0131
Pulled-point insert	350 µL	250 µL	100/pk	8010-0132
Flat bottom insert	440 µL	400 µL	500/pk	8010-0136

Microvolume Inserts for 4 mL (13 mm) Screw Top Vials

Description	Max Fill Volume	Recommended Fill Volume	Unit	Agilent CrossLab Part No.
Pulled-point insert with flange	350 µL	250 µL	100/pk	8010-0558



Microvolume inserts



250 µL conical insert with polymer feet, 8010-0131



250 µL pulled-point glass insert, 8010-0132



400 µL flat bottom glass insert, 8010-0136

CrossLab Well Plates and Sealing Mats

Choose the cleanest well plates and sealing mats for your autosamplers

Advantages of Agilent CrossLab well plates:

- Made from polypropylene
- Free from RNase, DNase, Endotoxins, and human DNA
- Chemically resistant to common solvents
- Autoclavable (121 °C/20 min)
- Alpha-numeric grid
- Compatible with pipetting workstations and multi-channel pipettes
- Raised rims are available with 0.5 mL and 1.0 mL deep well plates for efficient sealing and a reduced risk of cross-contamination during rigorous vortexing
- Available in 96- or 384-well plate format
- 96-well plates range from 0.2 mL to 2 mL
- 384-well plates available in 0.1 mL and 0.25 mL
- Stackable

Advantages of Agilent CrossLab sealing mats:

- Protect well contents during storage
- Free from RNase, DNase, Endotoxins, and human DNA
- Highly flexible for a tight seal and exact fit
- Insets in every well eliminate the need for glue during connection
- Pierceable with pipette tips (0.5 mL and 1.0 mL sealing mats)
- Prevent solvent evaporation
- Made from thermoplastic elastomer (TPE) or ethylene-vinyl acetate (EVA)
- Compatible with common solvents

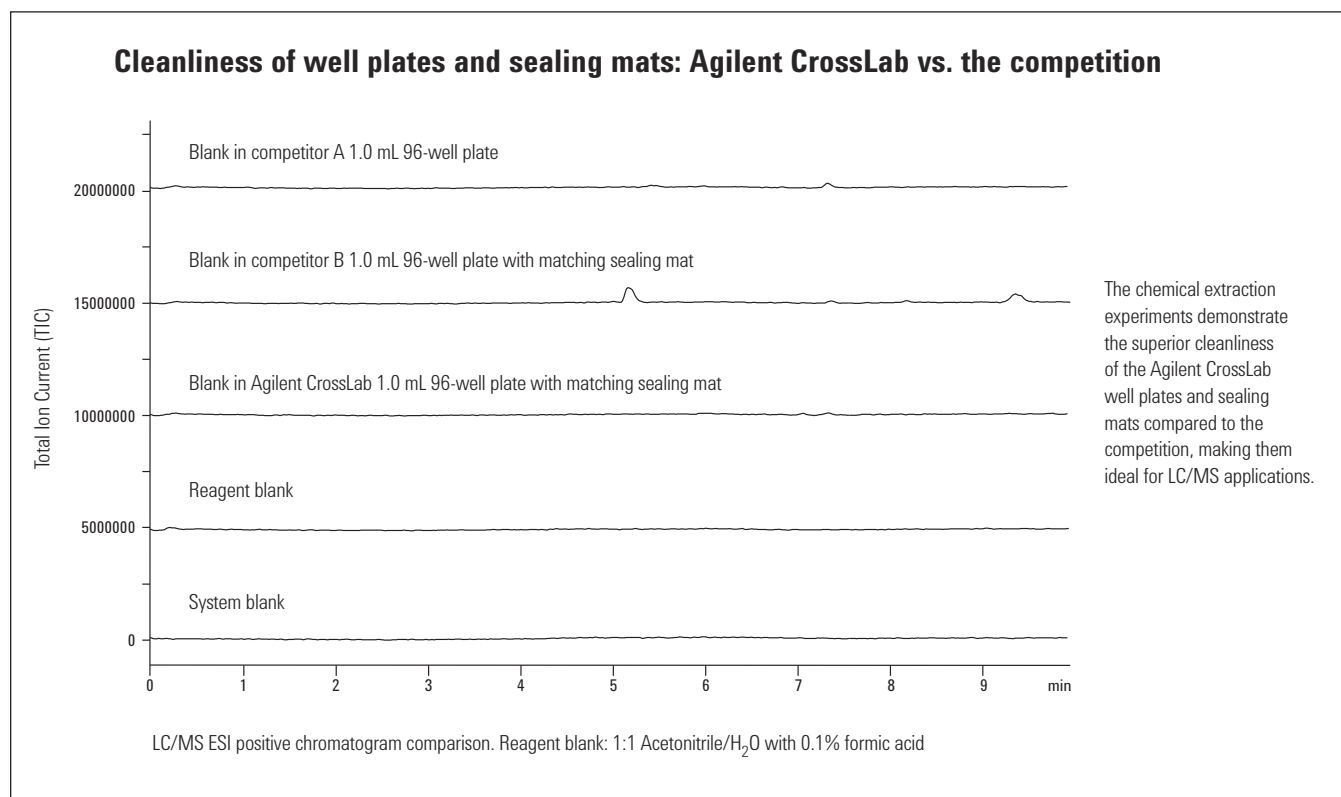

CrossLab Well Plates and Sealing Mats

Agilent CrossLab offers a range of polypropylene 96-well or 384-well plates with a variety of sealing options for collection of samples, storage, and use in autosamplers.

Well Plates

Description	Well Volume (mL)	Material	Plate Height (mm)	Well Depth (mm)	Well Shape	Bottom Shape	Unit	Agilent CrossLab Part No.
96-well plate	0.2	Polypropylene	20.9	20.9	Round	Conical	50/pk	8010-0532
96-well plate	0.5	Polypropylene	26.5	21.6	Round	Round	56/pk	8010-0533
96-well plate	1.0	Polypropylene	39.1	37.1	Round	Round	32/pk	8010-0534
96-well plate	2.0	Polypropylene	44	41.85	Round	Round	32/pk	8010-0536
384-well plate	0.1	Polypropylene	14.4	11.7	Square	Round	120/pk	8010-0538
384-well plate	0.25	Polypropylene	22	19.5	Square	Round	60/pk	8010-0539

Sealing Mats and Accessories

Description	Unit	Agilent CrossLab Part No.
Sealing mat for 0.2 mL 96-well plates, Thermoplastic Elastomers (TPE)	5/pk	8010-0577
Sealing mat for 0.5 mL and 1.0 mL 96-well plates, Thermoplastic Elastomers (TPE)	50/pk	8010-0535
Sealing mat for 2 mL 96-well plate, Ethylene Vinyl Acetate (EVA)	50/pk	8010-0537
Sealing tape for 384-well plate, polyethylene	100/pk	8010-0540
Sealing foil, self adhesive, high transparency, for all plates, Polyethylene terephthalate (PET)	100/pk	8010-0541
Sealing foil, self adhesive, for all plates, Polypropylene	100/pk	8010-0578



96-well plate, 8010-0534



96-well plate with removable sealing mat, 8010-0534



Sealing mat for 2 mL 96-well plate, (EVA), 8010-0537

CrossLab Vials Cross Reference List

The cross references to the original equipment manufacturer (OEM) part numbers listed here serve as a recommendation that the CrossLab products are viable alternatives to OEM products. CrossLab products are compatible with the corresponding OEM instruments, although in some cases, the CrossLab products may have slightly different designs as compared to the OEM counterparts.

CrossLab Vials for Bruker/Varian

Similar to Bruker/Varian Part No.	Agilent CrossLab Part No.
392611525	8010-0195
392611530	8010-0414
392611549	8010-0198
392611550	8010-0199
392611593	8010-0125
190010204	8010-0131
392611594	
392620538	
392611596	8010-0132
392611636	
392611607	8010-0143
392611607	8010-0413
392611613	8010-0142
392611613	8010-0412
392611631	8010-0050
392611632	8010-0051
390886500	8010-0002
392611634	
392611639	8010-0011
392620550	
CP10271	
392611640	8010-0013
392611641	8010-0056
392611641	8010-0061
392611645	8010-0064
392611641	8010-0066
392611645	8010-0059
392611645	8010-0069
392611646	8010-0015
392611653	
392611654	8010-0017

(Continued)

CrossLab Vials for Bruker/Varian

Similar to Bruker/Varian Part No.	Agilent CrossLab Part No.
392611659	8010-0084
392611659	8010-0086
392611659	8010-0088
392611667	8010-0159
392611675	8010-0034
392612021	
MLA202100	
392611857	8010-0151
392610003	8010-0116
392611858	
ROK7382420	
392611859	8010-0121
392611871	8010-0108
392611970	8010-0416
392611974	
392611975	
392611980	
392611981	
392611982	
392620104	8010-0040
392620202	8010-0042
392620204	8010-0044
392620302	8010-0139
392620304	
392620306	8010-0140
392620401	8010-0417
392620403	
392620500	8010-0175
CPLC40111B	
CPLC40111R	
190010209	8010-0092
392620510	

(Continued)

CrossLab Vials for Bruker/Varian

Similar to Bruker/Varian Part No.	Agilent CrossLab Part No.
190010209	8010-0093
392620510	
392620514	8010-0008
392620517	8010-0170
392620526	8010-0032
392620528	8010-0036
1600069800	8010-0070
390614901	8010-0072
6900016900	
R005486RT1	
CP10204	8010-0029
CP10205	8010-0033
CP10277	8010-0020
CP741315	8010-0038
CP913323	
CP912446	8010-0418
CP913077	
CP959464	8010-0420
CP959485	8010-0155
39260500	8010-0014
CPLC40111B	
CPLC40111R	
CPLCL07CPVA	8010-0172
CPLCL11ACBST144	8010-0183
MLA110040M	8010-0152
392611860	8010-0165
392612017	
MLA2000051ML	
MLA21000	8010-0030
R000548SCY	8010-0160

CrossLab Vials for PerkinElmer

Similar to PerkinElmer Part No.	Agilent CrossLab Part No.
B0104239	8010-0143
B0104241	8010-0144
B4000022	8010-0122
B4000025	8010-0121
N6356478	8010-0030
N6356479	8010-0038
N9300500	8010-0195
N9300700	8010-0198
N9301385	8010-0002
N9302680	8010-0003
N9302684	8010-0047
N9302685	8010-0048
N9302686	8010-0046
N9303416	8010-0106
N9303416	8010-0113
N9303417	8010-0105
N9303417	8010-0112
N9303418	8010-0024
N9303419	8010-0104
N9303419	8010-0111
N9303441	8010-0055
N9303442	8010-0073
N9303992	8010-0413
N9306015	8010-0051
N9306052	8010-0054
N9306075	8010-0042
N9306077	8010-0119
N9306079	8010-0034
N9306201	8010-0015
N9306202	8010-0086
N9306207	8010-0023
N9306208	8010-0025
N9306220	8010-0017
N9306228	8010-0050
N9306229	8010-0049
N9306240	8010-0152
N9306247	8010-0020

CrossLab Vials for Shimadzu

Similar to Shimadzu Part No.	Agilent CrossLab Part No.
038-00165-06	8010-0011
220-90384-00	8010-0055
220-90393-00	8010-0020
220-90394-00	8010-0096
220-91521-14	8010-0095
220-94562-00	8010-0412
220-94563-00	8010-0413
220-94796-01	8010-0042
220-94796-02	8010-0119
220-94796-07	8010-0038
221-34271-92	8010-0054
221-34271-92	8010-0056
221-34271-92	8010-0072
228-21290-91	8010-0098
228-45450-91	8010-0198
228-45452-91	8010-0199

CrossLab Vials for Thermo Scientific

Similar to Thermo Scientific Part No.	Agilent CrossLab Part No.
60180-507	8010-0008
10-800-247	8010-0038
14-824-365	8010-0042
60180-502	8010-0001
C4011-1W	
2-CV	
11 09 0476	
60180-504	8010-0030
10-800-246	
60180-505	8010-0032
14-824-360	
60180-506	8010-0034
60180-507	8010-0008
60180-508	8010-0010
60180-509	8010-0014
C4000-1W	
2SVW	
11 09 0519	

(Continued)

CrossLab Vials for Thermo Scientific

Similar to Thermo Scientific Part No.	Agilent CrossLab Part No.
60180-510	8010-0020
C4015-1	
4-SV	
13 09 0222	
60180-511	8010-0116
60180-513	8010-0117
60180-514	8010-0055
60180-514	8010-0060
60180-514	8010-0065
60180-514	8010-0070
60180-515	8010-0061
60180-516	8010-0086
60180-521	8010-0122
60180-522	
60180-526	8010-0046
60180-560	8010-0012
60180-561	8010-0016
C4000-2W	
2SVW(A)	
11 09 0520	
60180-562	8010-0066
60180-597	8010-0195
60180-599	8010-0198
60180-713	8010-0112
C4013-98Y	8010-0166

CrossLab Vials for Waters

Similar to Waters Part No.	Agilent CrossLab Part No.
186000842	8010-0557
186001420	8010-0563
186001421	8010-0565
186001422	8010-0564
186000307C	8010-0542
186000838C	8010-0553
186000839C	8010-0555
186000847C	8010-0543
186001133C	8010-0554
186001134C	8010-0556
WAT025053C	8010-0575
WAT025054C	8010-0574

Agilent Syringes

With a broad selection of syringes for manual and auto injectors, Agilent has what you need for accurate and effective sampling.

Whether you need an autosampler or manual syringe, there are two keys to choosing the right syringe – identifying your sample type and establishing the smallest volume to be dispensed or injected. Agilent offers two varieties of syringes.

PTFE-Tipped Syringes for Gases and Liquids

PTFE-tipped syringes have a precision-machined plunger tip that forms a tight seal and enables the tip to wipe the barrel's interior free of sample during operation. This feature is particularly useful for viscous or heterogeneous samples, because it reduces deposits that can cause the plunger to freeze. Replacement plunger assemblies are available for most PTFE-tipped syringes.

Fitted Plunger Syringes for Liquids

Fitted plunger syringes feature a stainless steel plunger that is meticulously hand-fitted to its matching glass barrel, creating a liquid-tight seal. These syringes are ideal for homogenous samples that are not prone to precipitation or bonding with glass. **Note:** plungers cannot be interchanged or replaced if damaged.

Syringe Features

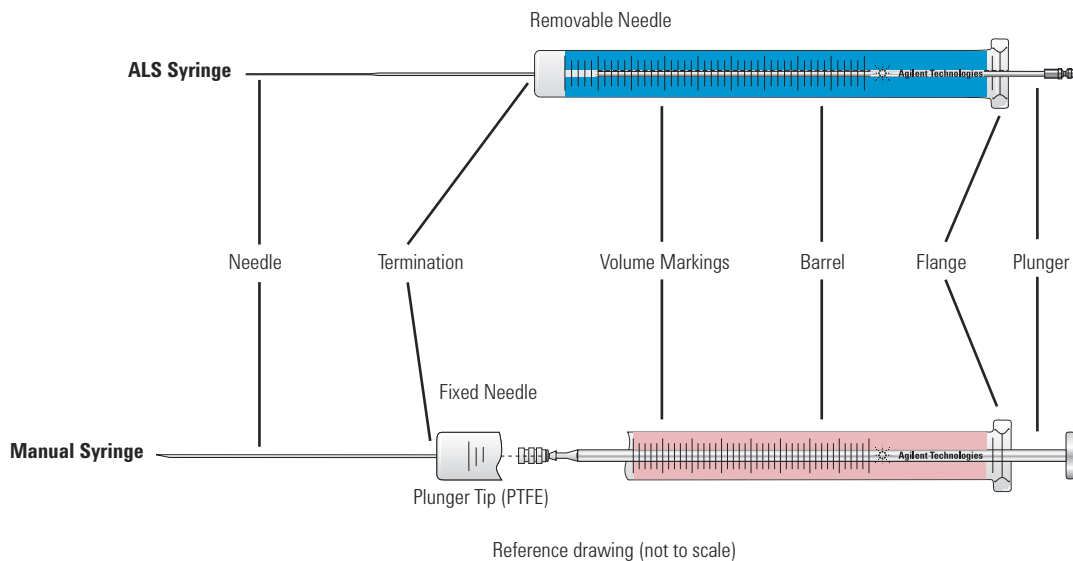

Needle Gauge

Needle gauge is the thickness of the needle. The gauge depends on the injector. When selecting a needle gauge, it is important to keep in mind the volume of the syringe and the dead volume of the needle. Refer to the chart below to choose a needle gauge with an appropriate dimension before selecting a needle.



Typical Needle Gauge Dimensions

Gauge	OD		ID	
	mm	inches	mm	inches
22	0.71	0.028	0.41	0.016
23s	0.635	0.025	0.11	0.0045
25	0.50	0.020	0.20	0.008
26s	0.47	0.0184	0.11	0.0045

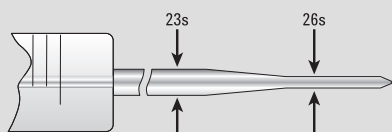

Tapered Dual Gauge 23-26 or 23s-26s (0.64-0.47 mm)

Durability of a 23-gauge

Versatility of a 26-gauge for split/splitless and on-column injection

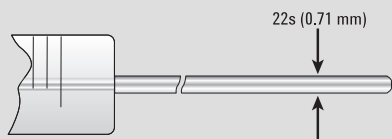

Single Gauge 22 (0.71 mm)

HPLC valves

Pipetting liquids

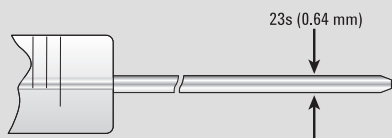

Single Gauge 23 or 23s (0.64 mm)

Merlin Microseal septa

Packed column injector ports

Split/splitless injector ports

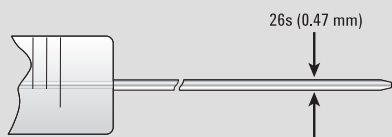

Single Gauge 26 or 26s (0.47 mm)

Packed column injector ports

Split/splitless injector ports

Note: Needles with an 'S' following the gauge are more durable, with a thicker needle wall and smaller id bore.

Needle Termination

Needle terminations are available in fixed or removable, with various tip styles:

- **Fixed (cemented)** – Economical, reproducible injections for autosamplers
- **Removable needle** – One syringe fixed – many methods, simplicity of fixed needle, but needle can be replaced if damaged or clogged
- **Luer tip** – Easy, fast needle replacement, syringe filter or pump priming, Luer tip is ground glass suitable for mounting chromatographic or PTFE needles, syringes can be autoclaved (without plunger or needle)
- **Luer Lok** – Security of a locked needle, syringe filter or pump priming, PTFE, male Luer taper with nickel-plated brass locking hub for use with KEL-F or metal hub needles and universal connectors

Needle Tip Design



HP Tip
(also referred to as
Cone or Point Style AS)

Proprietary design required for Agilent autosamplers for optimal performance and reliability by reducing septum coring.



Bevel Tip
(Point Style 2, BV)

General purpose; excellent choice for transferring liquids from ampoules or vials. For manual GC injections, a beveled tip is preferred for optimum septum penetration and to prevent septum coring.



LC Tip
(Point Style 3)

For HPLC injections and sample pipetting, the blunt tip style 3 is preferred. The blunt tip has chamfered and polished edges that eliminate damage to the valve's rotor seal and stator face. This style can also be used for pipetting liquids.



Side Hole
(Point Style 5)

Recommended for thin gauged septa or large volume injections.

Autosampler Syringes

Premium autosampler syringes optimize system productivity and ensure precise sample handling

Agilent Blue Line Autosampler Syringes for 7693A ALS

Agilent blue line autosampler syringes are specifically designed to support the higher productivity features of the 7693A ALS, while increasing plunger life and reducing costly downtime. Backed by over 40 years of chromatography experience, these meticulously crafted syringes offer:

- Wider range of volumes including exclusive 250 and 500 μL syringes for sample enhancement with the new 7693A
- Precise match with your autosampler's stroking mechanism, resulting in more accurate volume delivered
- Smooth needle that reduces septum coring and keeps your system working at its full potential
- Choice of PTFE-tipped or metal fitted plunger to meet application needs
- Easy-open, environmentally friendly packaging
- Certified compliance with strict Agilent specifications



Blue line autosampler syringe shown in 7693A ALS, G4513-80204

TIPS & TOOLS

Order your free GC troubleshooting and GC column installation posters at www.agilent.com/chem/GCposteroffer



Blue Line Autosampler Syringes with Fitted Plungers

Fitted plunger syringes are recommended for homogeneous liquid samples. Each fitted syringe is individually matched with the plunger for precision injection. Plungers are not interchangeable or replaceable.



Blue line autosampler syringe, G4513-80205



Blue line autosampler syringe, G4513-80204

Blue Line Autosampler Syringes with Fitted Plungers

Volume (µL)	Description	Unit	Needle Gauge/Length (mm)/Tip	Part No.
1	Plunger in needle, fixed		23/42/cone tipped	G4513-80229
	Replacement needle/plunger			G4513-80240
2	Plunger in needle, fixed		23/42/cone tipped	G4513-80215
	Replacement needle/plunger			G4513-80239
5	Straight, fixed		23/42/HP	G4513-80213
	Straight, fixed	6/pk	23/42/HP	G4513-80205
	Straight, fixed		26s/42/HP	G4513-80226
	Straight, fixed	6/pk	26s/42/HP	G4513-80212
	Tapered, fixed		23-26s/42/HP	G4513-80206
	Tapered, fixed	6/pk	23-26s/42/HP	G4513-80201
	Straight, removable		23/42/HP	G4513-80234
	Replacement needle	3/pk	23/42/HP	G4513-80236
	Tapered, removable		23-26s/42/HP	G4513-80224
	Replacement needle	3/pk	23-26/42/HP	G4513-80225
10	Straight, fixed		23/42/HP	G4513-80209
	Straight, fixed	6/pk	23/42/HP	G4513-80202
	Straight, fixed		26s/42/HP	G4513-80216
	Straight, fixed	6/pk	26s/42/HP	G4513-80211
	Tapered, fixed		23-26s/42/HP	G4513-80204
	Tapered, fixed	6/pk	23-26s/42/HP	G4513-80200
	Straight, removable		23/42/HP	G4513-80235
	Replacement needle	3/pk	23/42/HP	G4513-80236
	Removable		23-26s/42/HP	G4513-80218
	Replacement needle	3/pk	23-26/42/HP	G4513-80225
25	Tapered, fixed		23-26/42/HP	G4513-80242
50	Tapered, fixed		23-26/42/HP	G4513-80244
100	Tapered, fixed		23-26/42/HP	G4513-80243

Blue Line Autosampler Syringes with PTFE-Tipped Plungers

Suitable for gas and liquid samples, the PTFE tip of the plunger creates a tight seal between the plunger and glass, helping to reduce carry-over and increase syringe lifetime. Replacement plungers are available.

Blue Line Autosampler Syringes with PTFE-Tipped Plungers

Volume (µL)	Description	Unit	Needle Gauge/Length (mm)/Tip	Part No.
10	Straight, fixed		23/42/HP	G4513-80220
	Straight, fixed	6/pk	23/42/HP	G4513-80210
	Tapered, fixed		23-26/42/HP	G4513-80203*
	Replacement plunger for fixed needle			G4513-80227
	Tapered, fixed	6/pk	23-26s/42/HP	G4513-80208
	Straight, removable		23/42/HP	G4513-80219
	Replacement needle	3/pk	23/42/HP	G4513-80236
	Tapered, removable		23-26/42/HP	G4513-80233
	Replacement needle	3/pk	23-26/42/HP	G4513-80225
25	Straight, fixed		23/42/HP	G4513-80228
	Tapered, fixed		23-26/42/HP	G4513-80241
50	Straight, fixed		23/42/HP	G4513-80221
	Tapered, fixed		23-26/42/HP	G4513-80223
100	Tapered, Fixed		23-26s/42/HP	G4513-80222

*Included in 7693A shipments



Needles, replacement, G4513-80236

Advanced Sample Enhancement Autosampler Syringes with PTFE-Tipped Plungers

Used with the 7693A optional Enhanced Sample Handling Syringe Carriage, these syringes can eliminate analyst-to-analyst variability and reduce re-work in sample preparation, such as dilution and internal standard addition.

Advanced Sample Enhancement Autosampler Syringes with PTFE-Tipped Plungers

Volume (µL)	Description	Needle Gauge/Length (mm)/Tip	Part No.
250	Fixed, advanced sample enhancement	23/42/HP	G4513-60560
500	Fixed, advanced sample enhancement	23/42/HP	G4513-60561



Blue line autosampler syringe, G4513-60560

Gold Standard Autosampler Syringes

Use one needle and get the benefits of two. The upper portion of the tapered needle offers the strength of a 23-gauge needle, while the lower portion at 26s-gauge allows use with split/splitless or on-column injections with 0.53 mm id columns. All standard plungers are stainless steel.

Tapered Needle, 23-26s Gauge Autosampler Syringes

Volume (μL)	Description	Unit	Needle Gauge/Length (mm)/Tip	Part No.
5	Tapered, fixed		23-26s/42/HP	5181-1273
	Tapered, fixed	6/pk	23-26s/42/HP	5181-8810
	Tapered, removable		23-26s/42/HP	5182-0835
	Replacement needle for 5 μL syringe	3/pk		5182-0832
10	Tapered, fixed		23-26s/42/HP	5181-1267
	Tapered, fixed	6/pk	23-26s/42/HP	5181-3360
	Tapered, removable		23-26s/42/HP	5181-3321
	Replacement needle for 10 μL syringe	3/pk		5181-3319
	Tapered, fixed, PTFE-tipped plunger		23-26s/42/HP	5181-3354
	Tapered, fixed, PTFE-tipped plunger	6/pk	23-26s/42/HP	5181-3361
	Replacement plunger with PTFE tip for fixed needle 10 μL syringe			5181-3365
	Tapered, removable		23-26s/42/HP	5181-3356
	Replacement plunger with PTFE tip for removable needle 10 μL syringe			5181-3358
50	Tapered, fixed, PTFE-tipped plunger		23-26s/42/HP	5183-0314
100	Tapered, fixed, PTFE-tipped plunger		23-26s/42/HP	5183-2042



Straight Needle, 23 and 26s Gauge Autosampler Syringes

Volume (μL)	Description	Unit	Needle Gauge/ Length (mm)/Tip	Part No.
1	Cone-tipped		23/42/HP	5188-5246
1	Replacement needle/plunger for 1.0 μL syringe		23/42/HP	5188-5370
0.5	Replacement needle/plunger for 0.5 μL syringe		23-26/42/HP	5190-3193
2	Cone-tipped		23/42/HP	5188-5247
	Replacement needle/plunger for 2.0 μL syringe		23/42/HP	5188-5371
5	Straight, fixed		26s/42/HP	9301-0891
	Straight, fixed	6/pk	26s/42/HP	5183-4728
	Straight, fixed		23/42/HP	9301-0892
	Straight, fixed	6/pk	23/42/HP	5182-0875
	Straight, removable		23/42/HP	5182-0834
	Replacement needle for 5 μL syringe	3/pk		5182-0830
10	Straight, fixed		26s/42/HP	9301-0714
	Straight, fixed	6/pk	26s/42/HP	5183-4729
	Straight, fixed		23/42/HP	9301-0713
	Straight, fixed	6/pk	23/42/HP	9301-0725
	Straight, fixed, PTFE-tipped plunger		23/42/HP	5181-8809
	Straight, fixed, PTFE-tipped plunger	6/pk	23/42/HP	5183-4730
	Replacement plunger for 10 μL fixed needle syringe			5181-8808
	Straight, removable		23/42/HP	5181-8806
	Straight, removable, PTFE-tipped plunger		23/42/HP	5181-8813
	Replacement needle for 10 μL syringe	3/pk		5181-8811
	Replacement plunger with PTFE tip for removable needle 10 μL syringe			5181-3358
25	Straight, fixed, PTFE-tipped plunger		23/42/HP	5183-0316
50	Straight, fixed, PTFE-tipped plunger		23/42/HP	5183-0318
100	Straight, fixed, PTFE-tipped plunger		23/42/HP	5183-2058



Autosampler Syringes



7673/7683 On-Column Autosampler Syringes

Agilent 7673/7683 on-column syringes with needle diameter for columns ranging from 0.25 mm to 0.53 mm are specifically designed for the 7673/7683 Autosampler.

7673/7683 On-Column Autosampler Syringes

Volume (µL)	Description	Unit	Part No.
5	Removable needle, syringe only		5182-0836
	Stainless steel needle for 0.53 mm column	3/pk	5182-0832
	Stainless steel needle for 0.32 mm column	3/pk	5182-0831
	Stainless steel needle for 0.25 mm column	3/pk	5182-0833
	Plunger button	10/pk	5181-8866



HP 7670/71/72 Autosampler Syringes

This syringe has a long needle and regular plunger button for compatibility with HP 7670/71/72 autosamplers. Available with a fixed or removable needle.

HP 7670/71/72 Autosampler Syringes

Volume (µL)	Description	Needle	Part No.
1	Straight, removable	23/56/2	5182-9622
10	Straight, fixed	23/50/HP	5182-9734
	Straight, removable	23/50/HP	5182-9626
	Straight, fixed, PTFE-tipped plunger	23/50/HP	5182-9799

Autosampler syringe, 10 µL, straight, RN, 5182-9626











Manual Syringes

Agilent color-coded manual syringes allow you to determine syringe volume with one quick glance, so you can more efficiently perform manual dilution, extraction, and sample prep. They also give you the advantages of:

- Improved scale readability with a new vertical syringe scale orientation for more intuitive use
- A wide selection of volumes, making Agilent your "one-stop" resource for all of your sample manipulation needs
- Accuracy within $\pm 1\%$ of nominal volume, and precision within 1%, measured at 80% of total scale volume
- Earth-friendly cardboard and plastic packaging that could be recycled to help reduce landfill waste
- A Certificate of Conformance to ensure the highest quality construction and performance, available for viewing and printing anytime
- Lot-traceable for accurate identification

Of course, all Agilent syringes are backed by over 40 years of chromatography expertise, industry-leading technical support, and a 90-day warranty from the date of shipment.

Manual Syringes Color Code Chart

									
0.5 μL	1.0 μL	2.0 μL	5.0 μL	10 μL 1.0 mL	25 μL 2.5 mL	50 μL 5.0 mL	100 μL 10.0 mL	250 μL 25.0 mL	500 μL 50.0 mL



Manual syringe, 1.0 μ L, RN cone tip, 5190-1463

Manual Syringes with Fitted Plunger, Fixed and Removable Needle, 0.5 to 5 μ L

Volume (μ L)	Description	Unit Needle	Part No.
0.5	Plunger in needle, removable	23/70 mm/cone tip	5190-0464
	Replacement needle and plunger kit for 0.5 μ L syringe		5190-1461
	Plunger in needle, removable	23/70 mm/bevel tip	5190-1460
	Replacement needle and plunger kit for 0.5 μ L syringe		5190-1462
1.0	Plunger in needle, removable	26/70 mm/cone tip	5190-1463
	Replacement needle and plunger kit for 1.0 μ L syringe		5190-1467
	Plunger in needle, removable	26/70 mm/bevel tip	5190-1466
	Replacement needle and plunger kit for 1.0 μ L syringe		5190-1470
	Plunger in needle, removable	23/70 mm/cone tip	5190-1464
	Replacement needle and plunger kit for 1.0 μ L syringe		5190-1468
	Plunger in needle, removable	23/70 mm/bevel tip	5190-1465
	Replacement needle and plunger kit for 1.0 μ L syringe		5190-1469
2.0	Plunger in needle, removable	23/70 mm/cone tip	5190-1471
	Replacement needle and plunger kit for 2.0 μ L syringe		5190-1473
	Plunger in needle, removable	26/70 mm/bevel tip	5190-1472
	Replacement needle and plunger kit for 2.0 μ L syringe		5190-1474
5.0	Plunger in needle, removable	23/70 mm/cone tip	5190-1475
	Replacement needle and plunger kit for 5.0 μ L syringe		5190-1477
	Plunger in needle, removable	23/70 mm/bevel tip	5190-1476
	Replacement needle and plunger kit for 5.0 μ L syringe		5190-1478
	Straight, fixed	26/50 mm/bevel tip	5190-1479
	Removable, with flexible plunger	26/50 mm/bevel tip	5190-1481
	Replacement needle for 5.0 μ L syringe	3/pk	5190-1482

Manual Syringes with Fitted Plunger, Fixed and Removable Needle, 10 to 500 μ L

Volume (μ L)	Description	Unit	Needle	Part No.
10	Fixed		26/50 mm/bevel tip	5190-1483
	Fixed	10/pk	26/50 mm/bevel tip	5190-1487
	Fixed, with flexible plunger		26/50 mm/bevel tip	5190-1488
	Fixed, with flexible plunger	6/pk	26/50 mm/bevel tip	5190-1489
25	Fixed		25/50 mm/bevel tip	5190-1493
	Removable		25/50 mm/bevel tip	5190-1495
	Replacement needle	3/pk		5190-1496
50	Fixed		25/50 mm/bevel tip	5190-1500
	Removable		25/50 mm/bevel tip	5190-1502
	Replacement needle	3/pk		5190-1496
100	Fixed		25/50 mm/bevel tip	5190-1507
	Removable		25/50 mm/bevel tip	5190-1509
	Replacement needle	3/pk		5190-1496
250	Fixed		25/50 mm/bevel tip	5190-1514
	Removable		25/50 mm/bevel tip	5190-1516
	Replacement needle	3/pk		5190-1496
500	Fixed		25/50 mm/bevel tip	5190-1521
	Removable		25/50 mm/bevel tip	5190-1524
	Replacement needle	3/pk		5190-1496



Manual syringe, 50 μ L, FN bevel tip, 5190-1500



Manual Syringes with PTFE-Tipped Plunger, Removable Needle, 10 to 500 µL

Volume (µL)	Description	Unit	Needle	Part No.
10	Removable		25/50 mm/bevel tip	5190-1491
	Replacement needle	3/pk		5190-1496
	Replacement plunger with PTFE tip for 10 µL syringe			5190-1559
25	Removable		25/50 mm/bevel tip	5190-1498
	Replacement needle	3/pk		5190-1496
	Replacement plunger with PTFE tip for 25 µL syringe			5190-1560
50	Removable		25/50 mm/bevel tip	5190-1504
	Replacement needle	3/pk		5190-1496
	Replacement plunger with PTFE tip for 50 µL syringe			5190-1561
100	Removable		25/50 mm/bevel tip	5190-1511
	Replacement needle	3/pk		5190-1496
	Replacement plunger with PTFE tip for 100 µL syringe			5190-1562
250	Removable		25/50 mm/bevel tip	5190-1518
	Replacement needle	3/pk		5190-1496
	Replacement plunger with PTFE tip for 250 µL syringe			5190-1563
500	Removable		25/50 mm/bevel tip	5190-1525
	Replacement needle	3/pk		5190-1496
	Replacement plunger with PTFE tip for 500 µL syringe			5190-1564



Manual Syringes with PTFE-Tipped Plunger, Fixed Needle, 10 to 500 μ L

Volume (μ L)	Description	Needle	Part No.
10	Fixed	26/50 mm/bevel tip	5190-1490
	Replacement plunger with PTFE tip for 10 μ L syringe		5190-1558
25	Fixed	25/50 mm/bevel tip	5190-1497
	Replacement plunger with PTFE tip for 25 μ L syringe		5190-1560
50	Fixed	25/50 mm/bevel tip	5190-1503
	Replacement plunger with PTFE tip for 50 μ L syringe		5190-1561
100	Fixed	25/50 mm/bevel tip	5190-1510
	Replacement plunger with PTFE tip for 100 μ L syringe		5190-1562
250	Fixed	25/50 mm/bevel tip	5190-1517
	Replacement plunger with PTFE tip for 250 μ L syringe		5190-1563
500	Fixed	25/50 mm/bevel tip	5190-1523
	Replacement plunger with PTFE tip for 500 μ L syringe		5190-1564

Manual Syringes with PTFE-Tipped Plunger, Removable Needle, 1 mL to 10 mL

Volume (mL)	Description	Unit	Needle	Part No.
1.0	Removable		23/50 mm/bevel tip	5190-1529
	Replacement needle	3/pk		5190-1581
	Replacement plunger with PTFE tip for 1 mL syringes			5190-1565
2.5	Removable		23/50 mm/bevel tip	5190-1533
	Replacement needle	3/pk		5190-1581
	Replacement plunger with PTFE tip for 2.5 mL syringes			5190-1572
5.0	Removable		23/50 mm/bevel tip	5190-1537
	Replacement needle	3/pk		5190-1538
	Replacement plunger with PTFE tip for 5 mL syringes			5190-1573
10	Removable		23/50 mm/bevel tip	5190-1542
	Replacement needle	3/pk		5190-1538
	Replacement plunger with PTFE tip for 10 mL syringes			5190-1574



Manual syringe, 500 μ L, FN bevel tip, 5190-1523



Manual syringe, 1 mL, FN bevel tip, 5180-1528

Manual Syringes with PTFE-Tipped Plunger, Fixed Needle, 1 mL to 10 mL

Volume (mL)	Description	Needle	Part No.
1.0	Fixed	22/50 mm/bevel tip	5190-1528
	Replacement plunger with PTFE tip for 1 mL syringes		5190-1565
2.5	Fixed	22/50 mm/bevel tip	5190-1532
	Replacement plunger with PTFE tip for 2.5 mL syringes		5190-1572
5.0	Fixed	22/50 mm/bevel tip	5190-1536
	Replacement plunger with PTFE tip for 5 mL syringes		5190-1573
10	Fixed	22/50 mm/bevel tip	5190-1541
	Replacement plunger with PTFE tip for 10 mL syringes		5190-1574

Manual Syringe with PTFE-Tipped Plunger and Luer Lok, 50 to 500 µL

Volume (µL)	Description	Needle	Part No.
50	Luer Lok	Luer Lok/50 mm or 2 in	5190-1506
	Replacement plunger with PTFE tip for 50 µL syringe		5190-1561
100	Luer Lok	Luer Lok/50 mm or 2 in	5190-1513
	Replacement plunger with PTFE tip for 100 µL syringe		5190-1562
250	Luer Lok	Luer Lok/50 mm or 2 in	5190-1519
	Replacement plunger with PTFE tip for 250 µL syringe		5190-1563
500	Luer Lok	Luer Lok/50 mm or 2 in	5190-1527
	Replacement plunger with PTFE tip for 500 µL syringe		5190-1564



Manual Syringe with PTFE-Tipped Plunger and Luer Lok, 1 to 50 mL

Volume (mL)	Description	Needle	Part No.
1.0	Luer Lok	Luer Lok/50 mm or 2 in	5190-1530
	Luer Lok valve	Luer Lok valve/50 mm or 2 in	5190-1531
	Replacement plunger with PTFE tip for 1 mL syringes		5190-1565
2.5	Luer Lok	Luer Lok/50 mm or 2 in	5190-1534
	Luer Lok valve	Luer Lok valve/50 mm or 2 in	5190-1535
	Replacement plunger with PTFE tip for 2.5 mL syringes		5190-1572
5.0	Luer Lok	Luer Lok/50 mm or 2 in	5190-1539
	Luer Lok valve	Luer Lok valve/50 mm or 2 in	5190-1540
	Replacement plunger with PTFE tip for 5 mL syringes		5190-1573
10	Luer Lok	Luer Lok/50 mm or 2 in	5190-1457
	Luer Lok valve	Luer Lok valve/50 mm or 2 in	5190-1543
	Replacement plunger with PTFE tip for 10 mL syringes		5190-1574
25	Luer Lok	Luer Lok/50 mm or 2 in	5190-1544
	Replacement plunger with PTFE tip for 25 mL syringe		5190-1575
	Luer Lok valve	Luer Lok valve/50 mm or 2 in	5190-1545
	Replacement plunger with PTFE tip for 25 mL syringe		5190-1576
50	Luer Lok	Luer Lok/50 mm or 2 in	5190-1546
	Luer Lok valve	Luer Lok valve/50 mm or 2 in	5190-1547
	Replacement plunger with PTFE tip for 50 mL syringes		5190-1577



Luer Lok valve, 5190-1531



Luer Lok, 5190-1534



Luer Lok valve, 5190-1543

Luer Lok and Luer Lok Valve Needles

Description	Unit	Needle	Part No.
Luer Lok needle	3/pk	23/50/bevel tip	5190-1548
Luer Lok needle	3/pk	23/50/sidehole tip	5190-1549
Luer Lok needle	3/pk	22/51/LC tip	5190-1550



Syringe, 100 µL FN LC tip, 5190-1508

LC Manual Syringes with Fitted Plungers

Volume (µL)	Description	Unit	Needle	Part No.
5	Fixed		22 gauge/2 in/LC tip	5190-1480
10	Fixed		22 gauge/2 in/LC tip	5190-1484
	Removable		22 gauge/2 in/LC tip	5190-1485
	Replacement needle for 10 µL syringe	3/pk		5190-1486
25	Fixed		22 gauge/2 in/LC tip	5190-1494
50	Fixed		22 gauge/2 in/LC tip	5190-1501
100	Fixed		22 gauge/2 in/LC tip	5190-1508
250	Fixed		22 gauge/2 in/LC tip	5190-1515
500	Fixed		22 gauge/2 in/LC tip	5190-1522

LC Manual Syringes with PTFE-Tipped Plungers

Volume (µL)	Description	Unit	Needle	Part No.
10	Removable		22 gauge/2 in/LC tip	5190-1492
	Replacement needle for 10 µL syringe	3/pk		5190-1486
	Replacement plunger with PTFE tip for 10 µL syringe			5190-1558
25	Removable		22 gauge/2 in/LC tip	5190-1499
	Replacement needle	3/pk		5190-1571
	Replacement plunger with PTFE tip for 25 µL syringe			5190-1560
50	Removable		22 gauge/2 in/LC tip	5190-1505
	Replacement needle	3/pk		5190-1571
	Replacement plunger with PTFE tip for 50 µL syringe			5190-1561
100	Removable		22 gauge/2 in/LC tip	5190-1512
	Replacement needle	3/pk		5190-1571
	Replacement plunger with PTFE tip for 100 µL syringe			5190-1562
250	Removable		22 gauge/2 in/LC tip	5190-1520
	Replacement needle	3/pk		5190-1571
500	Removable		22 gauge/2 in/LC tip	5190-1526
	Replacement needle	3/pk		5190-1571
	Replacement plunger with PTFE tip for 500 µL syringe			5190-1564

Agilent CrossLab Syringes

CrossLab GC Autosampler Syringes

With a broad selection of syringes for auto injection, CrossLab autosampler syringes provide what you need for accurate and effective sampling. CrossLab syringes meet all fit, form, and function criteria for specific autosampler models. Agilent delivers more value in every autosampler syringe:

- Lot number printed directly on the barrel with a corresponding Certificate of Conformance
- Illuminating backing strip, for effortless viewing of the volume scale
- Environmentally friendly packaging and improved design that reduces waste
- Individually packaged for contaminant-free use right out of the box

Typical Needle Gauge Dimensions

Gauge	OD		ID	
	mm	inches	mm	inches
23	0.64	0.0248	0.11	0.0043
25	0.50	0.0197	0.20	0.0079
26	0.47	0.0184	0.11	0.0043



Autosampler syringe, 10 µL fixed needle, 8010-0351



Autosampler syringe, 5 µL, fixed needle, 8003-0001



Autosampler syringe, 5 µL, gas tight, fixed needle, 8003-0002

TIPS & TOOLS

Replace syringe if dirt is noticeable, syringe cannot be cleaned or plunger doesn't slide easily.
Replace needle if septa wear is abnormal or needle is clogged.



Needle Gauge

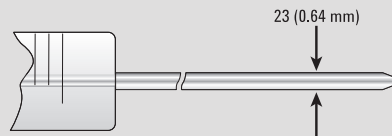

Single Gauge 23 (0.64 mm)
Packed column injector ports
Split/splitless injector ports

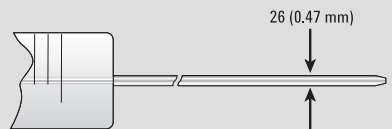

Single Gauge 26 (0.47 mm)
Packed column injector ports
Split/splitless injector ports

Needle Termination

Needle terminations are available in fixed or removable, with various tip styles.

Fixed (cemented)

- Economical, reproducible injections for autosamplers
- Preferred for applications requiring trace level samples
- Recommended for use where probability of needle bending is minimal
- Can be heated up to 70 °C

Removable needle

- Versatile option for injections
- Needle can be replaced if damaged or clogged
- Allows needle to be changed for different applications
- Can be heated up to 120 °C

TIPS & TOOLS



Follow manufacturer's recommendation for syringe cleaning and regularly inspect syringe barrel for sample build-up and needle tip for wear.



Autosampler Syringes for Bruker/Varian GC Systems, 1/pk

Model	Volume (µL)	Description	Needle Gauge/Length (mm)/Tip	Agilent CrossLab Syringe Part No.	Similar to Bruker/Varian Syringe Part No.	Agilent CrossLab Replacement Needle Part No.	Agilent CrossLab Replacement Plunger Part No.
CP8400 CP8410 CP9010 CP9050 AS200 AS2000 AS3000 AS800 TriPlus	10	Fixed needle	23/50/cone tip	8010-0351	SG002981		
CP8400 CP8410 CP9010 CP9050	10	Fixed needle	26/50/bevel tip	8004-0001			
CP8400 CP8410 CP9010 CP9050	10	Removable needle	26/50/cone tip	8004-0003	SG002982	8004-0004, 2/pk	
8035 8100 8200	10	Fixed needle, gas tight	26/53/side hole tip	8004-0002			8004-0007
	10	Removable needle, gas tight	25/53/side hole tip	8004-0005		8004-0006, 2/pk	8004-0007
CP8400 CP8410 CP9010 CP9050	10	Replacement needle		8004-0004			
8035 8100 8200	10	Replacement needle		8004-0006			
8035 8100 8200	10	Replacement plunger		8004-0007			

The cross references to the original equipment manufacturer (OEM) part numbers listed here serve as a recommendation that the Agilent CrossLab products are viable alternatives to OEM products. CrossLab products are compatible with the corresponding OEM instruments, although in some cases, the CrossLab products may have slightly different designs as compared to the OEM counterparts.



Autosampler Syringes for PerkinElmer GC Systems, 1/pk

Model	Volume (µL)	Description	Needle Gauge/ Length (mm)/ Tip	Agilent CrossLab Syringe Part No.	Similar to PerkinElmer Syringe Part No.	Agilent CrossLab Replacement Needle and Plunger Repair Kit Part No.	Similar to PerkinElmer Replacement Needle and Plunger Repair Kit Part No.
Autosystem Autosystem XL Clarus	0.5	Removable needle	23/70/cone tip	8003-0005	N6101252	8003-0006	N6101469
		Removable needle	26/70/bevelled cone tip	8003-0007		8003-0008	
	5	Fixed needle	23/70/cone tip	8003-0001	N6101251		
		Fixed needle, gas tight	23/70/cone tip	8003-0002	N6101390		
		Fixed needle	26/70/cone tip	8003-0003	N6101380		
	50	Fixed needle	23/70/cone tip	8003-0004	N6101760		
		Replacement needle and plunger repair kit		8003-0006	N6101469		
		Replacement needle and plunger repair kit		8003-0008			

The cross references to the original equipment manufacturer (OEM) part numbers listed here serve as a recommendation that the Agilent CrossLab products are viable alternatives to OEM products. CrossLab products are compatible with the corresponding OEM instruments, although in some cases, the CrossLab products may have slightly different designs as compared to the OEM counterparts.

Autosampler Syringes for Shimadzu GC Systems, 1/pk

Model	Volume (µL)	Description	Needle Gauge/Length (mm)/Tip	Agilent CrossLab Syringe Part No.	Similar to Shimadzu Syringe Part No.	Agilent CrossLab Replacement Needle Part No.	Similar to Shimadzu Replacement Needle Part No.
AOC-14	5	Fixed needle	23/42/cone tip	8001-0001			
AOC-17	10	Removable needle	23/42/cone tip	8001-0004	220-90282-20	8001-0005, 2/pk	220-90281-20
AOC-20		Removable needle	26/42/cone tip	8001-0006	220-90282-21	8001-0007, 2/pk	220-90281-21
	50	Fixed needle	23/42/cone tip	8001-0002	221-45243-00		
	250	Fixed needle, gas tight	23/42/cone tip	8001-0003	221-45244-00		

Autosampler Syringes for Shimadzu HPLC Systems, 1/pk

Model	Volume (µL)	Description	Needle Gauge/Length (mm)/Tip	Agilent CrossLab Syringe Part No.	Similar to Shimadzu Syringe Part No.	Agilent CrossLab Replacement Needle Part No.	Similar to Shimadzu Replacement Needle Part No.
SIL-10A SIL-10Ai	500	Chem (1/4-28 UNF screw threads), gas tight		8001-0401	228-25237-04		
	2.5	Chem (1/4-28 UNF screw threads), gas tight		8001-0402	228-25237-06		
	2.5	1/4-28 screw threads, gas tight with bracket		8001-0404	228-28128-91		

The cross references to the original equipment manufacturer (OEM) part numbers listed here serve as a recommendation that the Agilent CrossLab products are viable alternatives to OEM products. CrossLab products are compatible with the corresponding OEM instruments, although in some cases, the CrossLab products may have slightly different designs as compared to the OEM counterparts.



Autosampler Syringes for Thermo GC Systems, 1/pk

Model	Volume (µL)	Description	Needle Gauge/ Length (mm)/ Tip	Agilent CrossLab Syringe Part No.	Similar to Thermo Scientific Syringe Part No.	Agilent CrossLab Replacement Needle or Plunger Part No.	Similar to Thermo Scientific Replacement Needle or Plunger Part No.
AS3000 TriPlus	0.5	Plunger-in-needle	23/50/cone tip	8010-0355	36504045	8010-0367*	
TriPlus	5	Fixed needle	26/50/cone tip	8010-0353	36504047		
CP8400 CP8410 CP9010 CP9050 AS200 AS2000 AS3000 AS800 TriPlus	10	Fixed needle	23/50/cone tip	8010-0351	36520060		
AOC-14 AOC-17 AOC-20	10	Fixed needle	26/50/cone tip	8010-0352	365D3711		
AS200 AS2000 AS3000 AS800 TriPlus	10	Fixed needle	25/50/cone tip	8002-0003	36500525		
AS2000 TriPlus	10	Fixed needle	23/80/cone tip	8002-0002	36520061		
AS2000 TriPlus	10	Fixed needle	26/80/cone tip	8002-0001	36502019		
AS200 AS2000 AS800 TriPlus	100	Fixed needle, gas tight	23/50/cone tip	8010-0354		8010-0368**	
AS2000 TriPlus	100	Removable needle, gas tight	23/50/side hole tip	8002-0004	36520050	8002-0005***	36540040

*Needle and plunger repair kit

**Replacement plunger

***Replacement needle

The cross references to the original equipment manufacturer (OEM) part numbers listed here serve as a recommendation that the Agilent CrossLab products are viable alternatives to OEM products. CrossLab products are compatible with the corresponding OEM instruments, although in some cases, the CrossLab products may have slightly different designs as compared to the OEM counterparts.



Needle and plunger repair kit, 8010-0367



Replacement plunger, 8010-0368

CrossLab Supplies for CTC Analytics GC Autosamplers

Agilent's CrossLab portfolio includes a variety of syringes compatible with CTC Analytics GC PAL and CombiPAL systems.

- Syringe capacities from 0.5 μ L to 2.5 mL
- Fixed and removable needles
- Several needle tip styles to suit your application requirements
- High temperature syringes for headspace application with temperatures up to 150 °C
- PTFE plunger seal option for smooth, leak-free operation
- Syringe specifications are matched to CTC holders to ensure proper fit and reliable functioning



Autosampler Syringes for CTC CombiPAL and GC PAL, 1/pk

Volume (μ L)	Description	Needle Gauge/Length (mm)/Tip	Agilent CrossLab Syringe Part No.	Agilent CrossLab Replacement Needle or Plunger Part No.
0.5	Plunger-in-needle	23/50/cone tip	8010-0355	8010-0367*
5	Fixed needle	23/50/cone tip	8010-0356	
	Fixed needle	26/50/cone tip	8010-0353	
10	Fixed needle	23/50/cone tip	8010-0351	
	Fixed needle	25/50/cone tip	8002-0003	
	Fixed needle	26/50/cone tip	8010-0352	
	Fixed needle, gas tight	26/50/cone tip	8010-0357	8010-0359**
	Fixed needle	26/50/bevel tip	8010-0358	
25	Fixed needle	26/50/cone tip	8010-0360	
100	Fixed needle, gas tight	23/50/cone tip	8010-0354	
	Removable needle, gas tight	23/50/side hole tip	8002-0004	8002-0005***
	Fixed needle	26/50/cone tip	8010-0361	
250	Fixed needle, gas tight	26/50/cone tip	8010-0362	

Volume (mL)	Description	Needle Gauge/Length (mm)/Tip	Agilent CrossLab Syringe Part No.	Agilent CrossLab Replacement Plunger Part No.
1	Fixed needle, gas tight, headspace	23/56/side hole tip	8010-0363	8010-0365
2.5	Fixed needle, gas tight, headspace	23/56/side hole tip	8010-0364	8010-0366

*Needle and plunger repair kit

**Replacement plunger

***Replacement needle

The cross references to the original equipment manufacturer (OEM) part numbers listed here serve as a recommendation that the Agilent CrossLab products are viable alternatives to OEM products. CrossLab products are compatible with the corresponding OEM instruments, although in some cases, the CrossLab products may have slightly different designs as compared to the OEM counterparts.



Autosampler syringe, 10 μ L fixed needle, 8010-0351

Autosampler Syringes for Dionex LC Systems, 1/pk

Model	Volume (µL)	Description	Needle Gauge/ Length (mm)/ Tip	Similar to Dionex Syringe Part No.	Agilent CrossLab Syringe	Agilent CrossLab Replacement Needle	Agilent CrossLab Replacement Plunger
WPS-3000SL	25	Chem (1/4-28 UNF screw threads), gas tight		6822.0001	8002-0405		
	250	Chem (1/4-28 UNF screw threads), gas tight		6822.0003	8002-0407		
ASI-100	100	Removable needle, gas tight	22/51/3 22s/51/3	5805.2920	8002-0401*	8002-0413, 6/pk 8002-0412, 6/pk	8002-0402
	1,000	Removable needle, gas tight	22/51/3 22s/51/3	5805.2940	8002-0403*	8002-0414, 6/pk 8002-0415, 6/pk	8002-0406
	2,500	Removable needle, gas tight	22/51/3 22s/51/3	5805.2950	8002-0404*	8002-0414, 6/pk 8002-0415, 6/pk	8002-0408

*Needles are sold separately

The cross references to the original equipment manufacturer (OEM) part numbers listed here serve as a recommendation that the Agilent CrossLab products are viable alternatives to OEM products. CrossLab products are compatible with the corresponding OEM instruments, although in some cases, the CrossLab products may have slightly different designs as compared to the OEM counterparts.



Chem (1/4-28 UNF screw threads), gas tight, 8002-0405



Removable needle, gas tight, 8002-0401

Autosampler Syringes for Waters LC Systems, 1/pk

Model	Volume (µL)	Description	Needle Gauge/Length (mm)/Tip	Agilent CrossLab Syringe Part No.	Similar to Waters Syringe Part No.	Agilent CrossLab Replacement Needle or Plunger Part No.
2777 Compact Sample Manager	1	Fixed needle, gas tight	22/51/3	8010-0443	430000867	8010-0455
2777 Sample Manager	2.5	Fixed needle, gas tight	22/51/3	8010-0444	430000868	8010-0448
	10	Fixed needle	22s/51/3	8010-0445	430000859	
	25	Fixed needle, gas tight	22s/51/3	8010-0441	430000861	
	100	Fixed needle, gas tight	22s/51/3	8010-0442*	430000864	
		Fixed needle, gas tight	22/51/3	8010-0446*	430000863	
	250	Fixed needle, gas tight	22/51/3	8010-0467	430000865	
	500	Fixed needle, gas tight	22/51/3	8010-0468	430000866	8010-0460, 10/pk**
510 HPLC Pump	10000	Luer Lock	No needle	8005-0414	WAT025559	
515 HPLC Pump						
600 MultiSolvent Delivery System						
CapLC System						
CapLC XE System						
600 MultiSolvent Delivery System	25	Removable needle, gas tight	22s/51/3	8005-0416	WAT033381	
Rheodyne Injector	100	Removable needle, gas tight	22s/51/3	8005-0417	WAT033383	8005-0418, 6/pk
2690 Separations Module	25	Chem (1/4-28 UNF screw threads), gas tight	No needle	8005-0420	WAT077343	
2690D Dissolution Separations Module						
2695 Separations Module	250	Chem (1/4-28 screw threads UNF), gas tight	No needle	8005-0419	WAT073109	
2695D Dissolution Separations Module						
2790 Separations Module						
2795 Separations Module						
LC Module 1						
717/717plus Autosampler						

*Barrel od is 6.7 mm. All other 10, 25, and, 100 µL syringes have 7.9 mm od.

**Replacement plunger

The cross references to the original equipment manufacturer (OEM) part numbers listed here serve as a recommendation that the Agilent CrossLab products are viable alternatives to OEM products. CrossLab products are compatible with the corresponding OEM instruments, although in some cases, the CrossLab products may have slightly different designs as compared to the OEM counterparts.



Autosampler syringe, Luer Lock, 8005-0414



Autosampler syringe, gas tight, 8005-0417

CTC Autosampler Supplies

To better serve Agilent instrument users who choose CTC Analytics autosamplers for high-throughput and flexible sample introduction, Agilent has partnered with CTC to provide a fully integrated system, including CTC approved consumables.

Agilent's portfolio includes a variety of vials, caps, syringes, and well plates compatible with the CTC Analytics HTC PAL, GC PAL, and CombiPAL systems.



CombiPAL and GC PAL Liquid Injection Syringes

A key feature of CTC's GC PAL and CombiPAL is the ability to inject a wide range of sample volumes, up to 500 µL for LVI applications. The following fixed needle syringes are recommended by CTC to sustain high reproducibility and accuracy.



CTC syringes



Fixed needle, G6500-80120

CombiPAL and GC PAL Liquid Injection Syringes

Volume (µL)	Description	Unit	Needle	Part No.
1.2	Fixed needle		26/51/AS	G6500-80113
5	Fixed needle		26/51/AS	G6500-80114
	Removable needle for Cool On-Column (COC)		26/51/AS	5190-3984
	Replacement removable needle for Cool On-Column (COC)	3/pk		5190-3985
10	Fixed needle		26/51/2	G6500-80115
			26s/51/AS	G6500-80116
	Fixed needle, Merlin & PTV		23s/51/AS	5188-6596
25	Fixed needle		26/51/AS	G6500-80117
	Replacement plunger	10/pk		G4200-80104
100	Fixed needle		26/51/AS	G6500-80118
	Replacement plunger	10/pk		G4200-80105
250	Fixed needle		26/51/AS	G6500-80119
	Replacement plunger	10/pk		G4200-80102
500	Fixed needle		26/51/AS	G6500-80120
	Replacement plunger			G4200-80106

TIPS & TOOLS



For vials and caps that work seamlessly with your CTC Analytics PAL Autosamplers, see our complete Vials and Closures section, turn to page 27.

CombiPAL Headspace Supplies

Our fixed needle headspace syringes feature a sideport needle for gas flushing, in conformance with strict CTC standards. Use with Agilent's Merlin Microseal to minimize instrument downtime and to prevent lost or compromised data caused by septum leaks and liner contamination.

CombiPAL Headspace Syringes

Volume (mL)	Description	Gauge	Part No.
1	Fixed needle	23	G6500-80107
	Replacement plunger		G4200-80101
2.5	Fixed needle	23	G6500-80109
	Replacement plunger		G4200-80107
5	Fixed needle	23	G6500-80111
	Replacement plunger		G4200-80108

CombiPAL Headspace Supplies

Description	Part No.
Liner, inlet for SPME, deactivated	5188-6471
Liner, Ultra Inert for SPME, straight	5190-4048



Headspace Vials



Fixed needle, G6500-80109

HTS and HTC PAL Liquid Injection Crimp Top Micro Vials and Caps

HTS and HTC PAL high-throughput LC injection systems are configured to cope with today's high-throughput LC/MS demands. Agilent offers a selection of crimp top micro vials designed specifically for HTS and HTC PAL systems.

HTS and HTC PAL Liquid Injection Crimp Top Micro Vials and Caps

Description	Unit	Part No.
0.8 mL, amber glass, flat bottom	1000/pk	5183-4487
0.1 mL, clear glass, tapered bottom	500/pk	5180-0844
0.3 mL, clear glass, round bottom	500/pk	5180-0841
0.7 mL, amber glass, round bottom	500/pk	5180-0805
0.5 mL, amber glass, conical bottom	500/pk	5180-0806
Micro Caps		
Crimp caps with PTFE/silicone septa	500/pk	5180-0842

HTS and HTC PAL Liquid Injection Syringes

Designed specifically for CTC autosamplers, these X-type syringes feature zero carryover and a long-lasting plunger for applications that demand precision and productivity. They are strongly recommended for high-throughput applications.

Agilent offers a wide selection of fixed needle, 22-gauge, pointstyle 3 syringes to accommodate a variety of applications.



X-type fixed needle, G4200-80118



Replacement plunger, G4200-80111

HTS and HTC PAL Liquid Injection Syringes

Volume (µL)	Description	Unit	Needle	Part No.
25	X-type fixed needle		22s/51/3	G4200-80118
	Replacement plunger for X-type syringe	3/pk		G4200-80112
50	X-type fixed needle		22/51/3	5188-6485
	Replacement plunger for X-type syringe	3/pk		5188-5395
100	X-type fixed needle, fast aspiration and eject		22/51/3	G4200-80118
	X-type fixed needle, low dead volume		22s/51/3	G4200-80119
	Replacement plunger for X-type syringe	3/pk		G4200-80111
10	Fixed needle		22s/51/3	G4200-80113
	Replacement plunger	10/pk		G4200-80103
25	Fixed needle		22s/51/3	G4200-80114
	Replacement plunger	10/pk		G4200-80104
100	Fixed needle		22/51/3	G4200-80115
	Fixed needle		22s/51/3	G4200-80116
	Replacement plunger	10/pk		G4200-80105
250	Fixed needle		22/51/3	G6500-80102
	Replacement plunger	10/pk		G4200-80102
500	Fixed needle		22/51/3	G6500-80103
	Replacement plunger			G4200-80106
1000	Fixed needle		22/51/3	G6500-80104
	Replacement plunger			G4200-80101
2500	Fixed needle		22/51/3	G6500-80105
	Replacement plunger			G4200-80107
5000	Fixed needle		22/51/3	G6500-80106
	Replacement plunger			G4200-80108

HTS and HTC PAL Liquid Injection Valve Supplies

Whether your HTS or HTC PAL autosampler uses the Agilent proprietary Rheodyne high-pressure 600 bar injection valve or Valco Cheminert injection valves, Agilent can help you find a sample loop to meet your most challenging applications – including:

- Rheodyne 600 bar injection valve loops, which include high-pressure Swagelok fittings
- Cheminert metal loops, which feature two 1/16 in stainless steel nuts and two stainless steel ferrules
- Cheminert PEEK loops, which include two PEEK nuts and two PEEK ferrules

HTS and HTC PAL Liquid Injection Valve Loops and Needle Seals

Description	Part No.
Rheodyne 600 bar Valve Supplies	
Stainless Steel Loops: Supplied with Swagelok fittings required for high pressure	
5 μ L	5188-6486
10 μ L	5188-6487
20 μ L	5188-6488
50 μ L	5188-6489
100 μ L	5188-6490
Stator, Rheodyne 600 bar	5188-6491
RheBuild Kit, 600 bar, includes Rotor Seal and 3/32 in hex wrench	5188-6492
Needle Seals, Rheodyne valve, 600 bar, 10/pk	5188-6478
Cheminert Valve Supplies	
PEEK Loops: Include two PEEK nuts and two PEEK ferrules	
2 μ L	5188-6469
5 μ L	5188-6470
10 μ L	5188-6467
20 μ L	5188-6468
Metal Loops: Include two 1/16 in stainless steel nuts and two stainless steel ferrules	
2 μ L	5188-6457
10 μ L	5188-6458
50 μ L	5188-6460
100 μ L	5188-6461
250 μ L	5188-6462
500 μ L	5188-6463
1000 μ L	5188-6464
2000 μ L	5188-6465
5000 μ L	5188-6466
PEEK Needle Seal, Valco, 22-gauge, 10/pk	5188-6476
PTFE Needle Seal, Valco, 22-gauge, 10/pk	5188-6477



Stainless steel loop, 5188-6486



2 μ L PEEK loop, 5188-6469



10 μ L PEEK loop, 5188-6467

CTC Autosampler General Supplies

For your convenience, Agilent offers a selection of replacement sampling trays, well plates and sampling accessories for CTC autosamplers.



Sample tray, G6500-80101



Collection plate, showing
96-position closing mat, 5042-1389



Well plate foil cutter, 5188-6479

Description	Part No.
Sample tray, 200 vials, 0.7 or 1 mL	G6500-80100
Sample tray, 98 2 mL or 78 1 mL vials	G6500-80101
Sample tray, 32 10 or 20 mL vials	G6500-80121
Sample tray, 54 2 mL vials, for PAL deep-well stack	G6500-80122
96-well plates, 0.5 mL, polypropylene, 10/pk	5042-1386
96-deep well plates, 1 mL, polypropylene, 50/pk	5042-6454
384-well plates, 90 μ L, polypropylene, 30/pk	5042-1388
Closing mats for 96-well plates, silicone, pre-slit, fits 96-well plates P/N 5042-1385 and 5042-1386 only, 50/pk	5042-1389
Well plate foil cutter, max 22-gauge needle	5188-6479

Gas Management

Gas Purification

Impure gases can cause installation delays, premature instrument failure, and flawed results. Purification is one of the most important steps you can take to optimize your system performance.

Agilent brings the highest performance of gas purifiers to gas chromatographers. We manufacture purifiers in a variety of sizes and configurations to remove oxygen, moisture, and hydrocarbons. We recommend that each gas chromatograph use a gas purification system with removable cartridges such as Gas Clean or Renewable. These systems ensure the highest quality gas and contain indicators to allow for timely replacement before other consumables, like columns and liners, are damaged and sensitivity decreases. Agilent Gas Purifiers are a cost effective safety and preventive measure to assure the supply of the highest purity gas to your GC and GC/MS instrumentation with considerable savings in laboratory gas costs. We also carry a line of in-line purifiers to provide high capacity or economy solutions for customers. Please refer to the Gas Purifier Selection Guide to determine which gas purifiers you should use, see page 95.

Carrier Gas Purification

The Carrier Gas Purification illustration on the next page shows the most common gas purification configurations used in gas chromatography.

Regardless of which purification system is employed, proper installation and maintenance are required to achieve optimal performance. A purifier that is not maintained will eventually expire and become ineffective, or worse, a source of contamination.

Helpful Hints for Purification Success

- Keep number of fittings in gas line to a minimum
- Install purifiers in a convenient location close to the GC
- Use purifier log books to determine maintenance and cartridge replacement schedules
- Use indicating traps closest to the GC so you can determine when to change the traps that are upstream



Gas Clean Filters

TIPS & TOOLS

View the latest Agilent J&W GC column focused applications, products and educational resources at www.agilent.com/chem/mygccolumns





Connection Diagrams for Common Detectors

Detector	Connection Diagrams
<p>ECD Electron Capture Detector</p>	<p>The diagram shows two parallel gas lines. The top line starts with 'Carrier Gas' (green box), followed by an 'Oxygen Filter' (purple box), then a 'Moisture Filter' (teal box), and finally a 'Column' (yellow box). The bottom line starts with 'Nitrogen' (light green box), followed by an 'Oxygen Filter' (purple box), then a 'Moisture Filter' (teal box). From the 'Moisture Filter' on the bottom line, two arrows branch out: one labeled 'Anode Purge Gas' goes down and then right to the 'ECD' (yellow box); the other labeled 'Make-Up Gas' goes down and then right to the 'ECD'. The 'Column' from the top line also has an arrow pointing down and then right to the 'ECD'. The 'ECD' is at the bottom right of the diagram.</p>
<p>FID Flame Ionization Detector (Carrier Gas = Make-Up Gas)</p>	<p>The diagram shows three parallel gas lines. The top line starts with 'Carrier Gas' (yellow box), followed by an 'Oxygen Filter' (purple box), then a 'Moisture Filter' (teal box), and finally a 'Column' (yellow box). The middle line starts with 'Hydrogen' (magenta box), followed by a 'Charcoal Filter' (grey box). The bottom line starts with 'Air' (blue box), followed by a 'Charcoal Filter' (grey box). Arrows from the two 'Charcoal Filter' boxes merge and point to the 'FID' (yellow box). The 'Column' from the top line also has an arrow pointing down and then right to the 'FID'. The 'FID' is at the bottom right of the diagram.</p>
<p>FID Flame Ionization Detector (Carrier Gas differs from Make-Up Gas)</p>	<p>The diagram shows four parallel gas lines. The top line starts with 'Carrier Gas' (green box), followed by a 'GC/MS Filter' (magenta box), and finally a 'Column' (yellow box). The second line starts with 'Make-Up Gas' (brown box), followed by a 'Charcoal Filter' (grey box). The third line starts with 'Hydrogen' (magenta box), followed by a 'Charcoal Filter' (grey box). The bottom line starts with 'Air' (blue box), followed by a 'Charcoal Filter' (grey box). Arrows from the two 'Charcoal Filter' boxes merge and point to the 'FID' (yellow box). The 'Column' from the top line also has an arrow pointing down and then right to the 'FID'. The 'FID' is at the bottom right of the diagram.</p>

Detector	Connection Diagrams
<p>FPD Flame Photometric Detector</p> <p>PFPD Pulsed Flame Photometric Detector</p>	
<p>MS (ITD, MSD) Ion Trap Detector, Mass Selective Detector</p> <p>Two Possibilities (see diagrams to the right)</p>	
<p>NPD, PND Nitrogen-Phosphorus Detector</p> <p>TID, TSD Thermionic Detector (Carrier Gas = Make-Up Gas)</p>	
<p>TCD Thermal Conductivity Detector</p>	

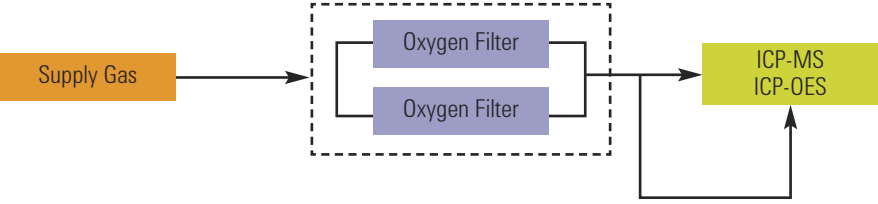
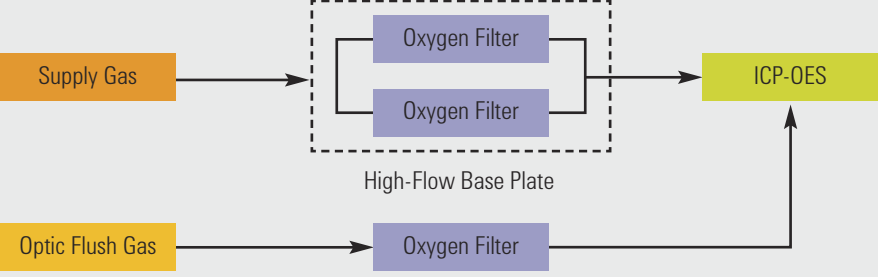
Connection Diagrams Analyzers and Generators

Detector	Connection Diagrams
<p>ICP-OES/ICP-MS</p> <p>Inductively Coupled Plasma-Optical Emission Spectrometry/Mass Spectrometry</p> <p>(Plasma Gas = Nebulizer Gas)</p>	
<p>ICP-OES</p> <p>Inductively Coupled Plasma-Optical Emission</p> <p>(Different Optic Flush Gas)</p>	
<p>Total Organic Carbon (TOC) Analyzer</p>	
<p>Zero-Air Generator</p>	

Key:

GC/MS Filter: A triple filter that removes oxygen, moisture, and hydrocarbons

Oxygen Filter: A filter that removes oxygen

Moisture Filter: A filter that removes water

Charcoal Filter: A filter that removes hydrocarbons

CO₂ Filter: A filter that removes carbon dioxide

Gas Purifier Selection Guide

Contaminant	Description	Series	Unique Features	Page No.
Purification Systems				
Hydrocarbon Moisture Oxygen	Gas Clean Filters*		Ships standard with GC/MS Systems, highly sensitive indicators with fast, leak-free filter replacement	96
Triple Filter (GC/MS) Carbon Dioxide Renewable Types: Triple Filter	Renewable Gas Purification System	G3440	Recyclable high-capacity system filters moisture, oxygen and hydrocarbons in a small, single-cartridge unit, featuring quick changes and easy-to-read dual indicators	100
In-Line Purifiers				
Moisture (H ₂ O)	Indicating Moisture Traps		Glass construction with plastic safety shield	104
	Big Moisture Traps	BMT	Ultra-high capacity for moisture	103
Oxygen (O ₂)	Indicating Oxygen Traps		Glass construction with plastic safety shield	105
	Oxygen Traps	OT1	Economical non-indicating oxygen trap	106
	Big Oxygen Traps	BOT	Ultra-high capacity for oxygen	103
Hydrocarbons (HCs)	Hydrocarbon Traps	HT	Economical trap for hydrocarbons	106
	Big Hydrocarbon Traps	BHT	Ultra-high capacity for hydrocarbons	103
Combination Traps	Oxygen/Moisture Trap	OT3	Economical bi-functional trap	108
	Hydrocarbon/Moisture Trap	HMT	Economical bi-functional trap	109
	Big Universal Trap	RMS	Gas-specific (for purifying He, N ₂ , or H ₂), ultra-high capacity, removes H ₂ O, O ₂ , HCs, CO, and CO ₂ , recommended for GC and GC/MS gas supplies	101
Other Purifiers				
Organics	Split Vent Trap	RDT	Cartridge design with durable cartridge holder and replacement cartridges	109

*Agilent Recommended

Gas Purification Systems

Agilent Gas Clean Filters

- Deliver clean gases for accurate analyses
- Fast, leak-free filter replacement reduces downtime
- Economical, with immediate payback
- Highly sensitive filter indicators provide maximum instrument protection

The Agilent Gas Clean Filter System delivers clean gases, reducing the risks of column damage, sensitivity loss, and instrument downtime. Inserting a Gas Clean Filter System in the gas line immediately before the instrument inlet greatly reduces the level of impurities, thus improving trace analysis. Contaminants entering your GC column will also be reduced, which is critical for high temperature analysis and essential for longer column lifetime.

Replacing the filters when they have reached absorption capacity ensures maximum protection of your GC columns and analytical hardware. The sensitive indicators change color, alerting you that the filter needs to be replaced.

A Gas Clean Filter System allows you to use 99.996% (4.6) pure helium instead of the more expensive 99.999% (5.0) or 99.9999% (6.0) grade, while still yielding high quality analytical results. The expected cost savings are 30%.



The unique connection design allows fast, leak-free replacement of the Gas Clean Filter

TIPS & TOOLS



Learn best practices for GC troubleshooting with the Agilent GC Troubleshooting video series – view at www.agilent.com/chem/GCtroubleshooting



Benefits of Using Gas Clean Filters

Technique	Filters	Benefit
GC/MS	GC/MS filter	Higher data accuracy and less maintenance
GC column	Moisture filter and oxygen filter or a GC/MS filter	Longer lifetime
ECD detector	GC/MS Filter	Greater sensitivity
TCD detector	Moisture filter and oxygen filter or a GC/MS filter	Greater sensitivity and less maintenance
Process GC	Process moisture filter	Long term stability
FID detector	Two charcoal filters (for air and hydrogen)	Greater sensitivity
PID detector	Oxygen filter and charcoal filter	Greater sensitivity
PFPD or FDP detector	Charcoal filter, CO ₂ filter and moisture filter	Greater sensitivity
TSD or NPD detector	Charcoal filter, CO ₂ filter and moisture filter	Greater sensitivity
Total organic carbon	CO ₂ filter and moisture filter	Greater sensitivity
Zero-air generator	CO ₂ filter and moisture filter	Cleaner gas
ICP-OES, ICP-MS	High flow connection unit with two oxygen filters	Greater sensitivity

Gas Clean Filters Technical Specifications

Description	Function	Indicator Color Change	Capacity	Outlet Concentration (at operating flow of 1-10 L/min)
Oxygen Filter	Removes oxygen as well as traces of sulfur and chlorine compounds from carrier gas	From green to gray	150 mL oxygen	< 50 µg/L
Moisture Filter/Process Moisture Filter	Removes water, oil, and other foreign material from the carrier gas	From green to pale brown	7.2 g water	< 0.1 mg/L
Charcoal Filter	Removes organic compounds from gas streams	No indicator	Approximately 7 g, depending on impurities	< 0.1 mg/L
GC/MS Filter	Single combination filter, removes water, oxygen, and organic compounds	Oxygen, from green to gray; Moisture, from green to pale brown	100 mL oxygen, 1 g water, organics depending on impurities	Oxygen < 50 µg/L Moisture < 0.1 mg/L Organics < 0.1 mg/L
CO₂ Filter	Removes CO ₂ from the gas stream; use with moisture filter	From white to violet	9 g CO ₂	< 1 mg/L



Gas Clean Filters



1-position connecting unit, 1/8 in, CP7988



4-position connecting unit, 1/8 in, CP736520



High flow connecting unit 1/8 in, CP17985

Agilent Gas Clean Filter Starter Kits

Description	Part No.
Agilent Gas Clean FID Filter kit Includes a 4-position 1/8 in connecting unit and two Charcoal filters, one Oxygen filter, and one Moisture filter	CP7995*
Agilent Gas Clean Filter Kit, 1/8 in Includes a 4-position 1/8 in connecting unit and two Charcoal filters, one Oxygen filter, and one Moisture filter	CP736530
Agilent Gas Clean GC/MS Filter kit Includes a 1-position connecting unit 1/8 in and two GC/MS filters	CP17976
Agilent Gas Clean GC/MS Filter kit Includes a 1-position connecting unit 1/4 in and two GC/MS filters	CP17977
Agilent Gas Clean GC/MS Filter Installation kit Includes 1 m copper tubing (P/N CP17976), two nuts and two ferrules, 1/8 in	CP17978
Agilent Gas Clean CO ₂ kit Includes 2-position 1/4 in connecting unit and CO ₂ and moisture filters	CP17982
Agilent Gas Clean CO ₂ kit Includes 2-position 1/8 in connecting unit and CO ₂ and moisture filters	CP17983
Agilent TCD Filter Kit Includes a 2-position 1/8 in connecting unit, one Oxygen filter, and one Moisture filter	CP738408
Agilent GC Installation Kit Includes CP736530 and many useful fittings and accessories.	19199N

*For 1/8 in tube, use reducer 1/8 in x 1/4 in, P/N CP4392

Connecting Units

Description	Part No.
1-position connecting unit, 1/4 in	CP7980
1-position connecting unit, 1/8 in	CP7988
2-position connecting unit, 1/4 in	CP738406
2-position connecting unit, 1/8 in	CP738407
4-position connecting unit, 1/4 in	CP7989
4-position connecting unit, 1/8 in	CP736520
High flow connecting unit, 2-position, 1/4 in	CP17984
High flow connecting unit, 2-position, 1/8 in	CP17985
1-position, stainless steel, 1/4 in tube	CP7980P4
1-position, stainless steel, 1/8 in tube	CP7988P8
1-position, stainless steel, 3 mm tube	CP7988P3
1-position, stainless steel, 6 mm tube	CP7980P6



Replacement Gas Clean Filters

Description	Part No.
Agilent Gas Clean CO ₂ filter	CP17969
Agilent Gas Clean Oxygen filter	CP17970
Agilent Gas Clean Moisture filter	CP17971
Agilent Gas Clean Process Moisture filter	CP17971P
Agilent Gas Clean Charcoal filter	CP17972
Agilent Gas Clean GC/MS filter*	CP17973

*GC/MS filter removes Hydrocarbons, Moisture, and Oxygen, and can be used to purify any GC carrier gas. It is the best filter for protecting your inert consumables.

Accessories and Fittings

Description	Part No.
Wall mounting bracket for connecting unit For CP7980 and CP7988	CP7981
Upper part filter connecting unit	CP7978
Flush head for connecting unit	CP7987
Male connector, 1/4 in with dust filter	CP7986
Male connector, 1/8 in with dust filter	CP82117
Viton O-rings, two sets	CP7983
Male connector, stainless steel, 1/4 in with dust filter	CP7986SS
Male connector, stainless steel, 1/8 in with dust filter	CP82117SS
Male connector, stainless steel, 3 mm with dust filter	CP82117SS3
Male connector, stainless steel, 6 mm with dust filter	CP7986SS6



Agilent Gas Clean GC/MS filter, CP17973



Wall mounting bracket for connecting unit, for CP7980 and CP7988, CP7981



Flush head for connecting unit, CP7987

TIPS & TOOLS

GC/MS filter removes Hydrocarbons, Moisture, and Oxygen and can be used to purify any GC carrier gas. It is the best filter for protecting your inert consumables.





Renewable gas purification system (left) and recycled cartridge (right)



Renewable gas purifier cartridge, new, G3440-60003

Renewable Gas Purification System

The Renewable Gas Purification System from Agilent not only traps large quantities of contaminants and lasts a long time, but it is also recyclable. With average use, you'll only need to purchase a replacement cartridge once per year or after approximately 20 cylinders' worth of purification. When you need a replacement, you have the option to purchase a new or recycled cartridge. Recycled cartridges are refilled and certified to the full specifications of the new cartridges.

- Agilent's highest capacity and most economical purification system
- All cartridges are environmentally friendly and reduce waste
- High capacity – 850 cc or more oxygen filtration, 12 g H₂O, and approximately 8 g hydrocarbon filtration per cartridge – in a compact footprint
- Improves 99.995% gas purity to 99.9995% purity
- Dual indicators make it easy to see the purification results
- Labeling displays indicator color and shape for accurate reading
- Simple twist on/off knob and guide rod make cartridge changes quick and easy
- One renewable gas purifier system can support up to four GC systems
- Designed with efficiency, safety, and environmental responsibility in mind
- All replacement cartridges include return packaging and instructions

Renewable Gas Purification System

Description	Part No.
Renewable gas purifier system startup kit Includes one G3440-80007 base, one G3440-60003 renewable gas purifier cartridge, wall or bench mount hardware, and instruction manual	G3440-60004
Renewable gas purifier cartridge, new	G3440-60003
Renewable gas purifier cartridge, recycled	G3440-69003
Renewable gas purifier system, base only	G3440-80007
Return packaging set For return of G3440-60003 or G3440-69003 renewable gas purification cartridge when original packaging is lost or damaged	5190-1414

TIPS & TOOLS



For more information about the Renewable Gas Purification System, visit www.agilent.com/chem/renewable

In-Line Gas Traps

The purpose of gas traps is to remove detrimental impurities from carrier and detector gases. Combination traps are available which remove moisture, oxygen, and/or organics with a single trap. The effectiveness of the traps depends on the initial quality of the gas.

Constant exposure of capillary columns to oxygen and moisture, especially at high temperatures, results in rapid and severe column damage. The use of oxygen and moisture traps for the carrier gas may extend column life and protect the instrument. Any moisture or oxygen introduced into the gas stream due to a leak will be removed by the trap until it expires.

Big Universal Traps

Big Universal Traps utilize a layered, multi-adsorbent bed packing of the most effective, highest capacity adsorbent materials available today for the removal of oxygen, moisture, hydrocarbons, carbon dioxide, and carbon monoxide from helium gas streams. The volume of the various adsorbent materials in the Big Universal Trap was developed through rigorous testing and evaluation in order to ensure that breakthrough of the five major contaminant groups occurs as simultaneously as possible as each material achieves complete saturation.

One Big Universal Trap unit will easily purify the contents of thirteen "K" size cylinders of 99.997% purity helium to a cumulative level of 100 µg/L of O₂, H₂O, CO₂, CO, and hydrocarbons at a flow rate of up to 8 L/min. All tube fittings are Swagelok stainless steel, fitted with 40 µm stainless steel frits for particulate control. Maximum pressure is 250 psi.

Big Universal Traps are more economical than other purifiers, offering nearly three times the capacity.

Big Universal Traps are ideal for any GC or GC/MS application where helium is employed and assurance of purity is essential. Combining the contents of three individual in-line traps into a single unit reduces the number of potential leaks and the possibility of aspirating contaminants into the gas stream. A single purifier also simplifies installation and replacement.



Big universal trap

TIPS & TOOLS

Big universal traps have nearly three times the capacity of other purifiers.



Capacity Data

High Purity Helium-99.997%		Removal Capacity
O ₂	< 5 mg/L	1.07 L
THC*	< 1 mg/L	20 g
H ₂ O	< 5 mg/L	46 g

*Total Hydrocarbons, analysis limited to three contaminant groups

Effluent Concentration

Research Grade Helium-99.9999%

Impurities	< 1 mg/L	H ₂ O	< 0.2 mg/L
N ₂	< 0.5 mg/L	H ₂	< 0.2 mg/L
O ₂	< 0.5 mg/L	Ar	< 0.1 mg/L
THC*	< 0.1 mg/L	Ne	< 0.5 mg/L
CO+CO ₂	< 0.1 mg/L		

*Total Hydrocarbons, analysis limited to three contaminant groups

Big Universal Traps (RMS Series)

Description	1/8 in	1/4 in
	Part No.	Part No.
Hydrogen	RMSHY-2	RMSHY-4
Helium (Ar/Me)	RMSH-2	RMSH-4
Nitrogen	RMSN-2	RMSN-4
Trap Mounting Clips		
Big Mounting Clip, 2/pk	UMC-5-2	UMC-5-2

Big Traps

- Pressure: Up to 250 psig
- 750 cm³ gas purifiers
- Ideal for bulk purification applications or where several instruments are plumbed from a single gas source
- One piece of heavy-walled aluminum tube eliminates potential leaks
- Equipped with sintered stainless steel frits to prevent particulate contamination



Big moisture trap

Big Moisture Traps (BMT Series)

Description	Capacity	Efficiency	1/8 in	1/4 in
			Part No.	Part No.
Big Moisture Trap	130 g H ₂ O	Reduction of H ₂ O to less than 5 µg/L	BMT-2	BMT-4
Mounting Clips				
Big Mounting Clip, 2/pk			UMC-5-2	UMC-5-2

Big Oxygen Traps (BOT Series)

Description	Capacity	Efficiency	1/8 in	1/4 in
			Part No.	Part No.
Big Oxygen Trap	3 L O ₂ or 3.2 g	Reduction of O ₂ to less than 1 µg/L	BOT-2	BOT-4
Trap Mounting Clips				
Big Mounting Clip, 2/pk			UMC-5-2	UMC-5-2

Big Hydrocarbon Traps (BHT Series)

Description	Capacity	Efficiency	1/8 in	1/4 in
			Part No.	Part No.
Big Hydrocarbon Trap	80 g of medium to heavy molecular weight hydrocarbons	Reduction of C ₄ hydrocarbons to less than 15 µg/L	BHT-2	BHT-4
Mounting Clips				
Big Mounting Clip, 2/pk			UMC-5-2	UMC-5-2

Indicating Moisture Traps

This is an advanced-design gas filter for applications requiring high-efficiency moisture removal with the benefit of a depletion indicator. The adsorbing materials are Molecular Sieve 5Å and cobalt-free indicator, held in a sturdy glass tube. The gas to be purified contacts only glass, metal and the absorbent.

The indicator changes color from greenish-yellow to blue at about 5% relative humidity to signal leaks in the system; the molecular sieve removes moisture to trace levels. The glass tube is sealed with a special dual sealing system for extra protection from leaks. An internal frit at each end prevents particulate contamination. The inner glass tube in the Moisture Trap is enclosed in a plastic outer tube for safety. Dimensions: 3.5 cm x 26 cm, maximum pressure 6.8 bar (100 psig).

Dual Seal Design: In this design the glass inner tube is protected by a sealed outer plastic tube. Even if the glass tube fails, the gas system is fully protected against leaks.

Description	1/8 in Part No.	1/4 in Part No.
Glass Indicating Moisture Trap	5182-9211	5182-9411



Glass Indicating Moisture Trap

Indicating Oxygen Traps

This is an improved, compact indicating filter for high-efficiency oxygen removal, suitable for use with chromatography carrier gas streams. It removes oxygen to low-ppb levels, with an indicator that changes color from green to gray when adsorption capacity is depleted. The adsorbent forms copper oxide in the presence of oxygen; no gas is generated.

The Glass Indicating Oxygen Trap is recommended as a downstream indicator for high-capacity traps. It can be used with non-oxidizing gases such as He, Ar, N₂, H₂ or CH₄, with maximum recommended flow rate of 150 cc/min. The absorbents are held in a heavy-walled inner glass tube, shielded by an outer clear plastic tube for increased safety. Maximum pressure is 6.8 bar (100 psig). Approximate dimensions are 3.5 cm x 26 cm including fittings.

Dual Seal Design: In this design the glass inner tube is protected by a sealed outer plastic tube. Even if the glass tube fails, the gas system is fully protected against leaks.

Description	1/8 in Part No.	1/4 in Part No.
Glass Indicating Oxygen Trap	5182-9201	5182-9401
Glass Indicating Oxygen Trap, Stainless Steel Fitting	5182-9202	5182-9402



Glass Indicating Oxygen Trap

Oxygen Traps

- Reduces oxygen to less than 1 µg/L
- Environmentally safe

This trap removes the oxygen rather than converting it to another form of contamination.



Economy non-indicating oxygen trap

Description	Size (cc)	1/8 in Part No.	1/4 in Part No.
Economy Non-Indicating Oxygen Traps (OT1 Series)			
Oxygen Trap	70	OT1-2	OT1-4
Trap Mounting Clips			
Mounting clip for OT1 traps		MC-1	MC-1

Hydrocarbon Traps

Hydrocarbon Traps



Hydrocarbon trap, HT200-2

Description	Size (cc)	1/8 in Part No.	1/4 in Part No.
Hydrocarbon Trap	200	HT200-2	HT200-4
Capillary Grade Hydrocarbon Trap	100	HT3-2	HT3-4
Mounting Clips			
Mounting clip for HT200 Series		MC-1	MC-1

**Ability of Activated Carbon to Remove Substances from Gases
Using Hydrocarbon Traps**

Compound	Efficiency	Compound	Efficiency
acetone	excellent	dissolved oils	excellent
hypochlorous acid	excellent	nitrobenzenes	excellent
alcohol	excellent	nitrotoluene	excellent
amines	very good	ethyl acetate	excellent
inorganic acids	none	ethyl alcohol	excellent
ammonia	poor	organic acids	excellent
iodine	excellent	ethyl chloride	excellent
amyl acetate	excellent	oxalic acid	excellent
isopropyl acetate	excellent	ethyl ether	excellent
amyl alcohol	excellent	ozone	excellent
isopropyl alcohol	excellent	fluoride	poor
benzene	excellent	phenol	excellent
ketones	excellent	formaldehyde	poor
butyl acetate	excellent	potassium permanganate	excellent
butyl alcohol	excellent	propyl acetate	excellent
lactic acids	excellent	glycol	excellent
by-products-organic	very good	propyl alcohol	excellent
lysol	excellent	propyl chloride	excellent
calcium hypochlorite	excellent	hydrogen bromide	satisfactory
mercaptans	excellent	hydrogen chloride	poor
carbon dioxide	none	sodium hypochlorite	excellent
methyl acetate	excellent	hydrogen fluoride	none
chlorobenzene	excellent	solvents	excellent
methyl alcohol	excellent	hydrogen iodide	satisfactory
chlorine	excellent	sulfuric acid	satisfactory
methyl bromide	excellent	hydrogen selenide	satisfactory
chlorophenol	excellent	hydrogen sulfide	satisfactory
methyl chloride	excellent	toluene	excellent
chlorophyl	excellent	trichloroethylene	excellent
methyl ethyl ketone	excellent	xylene	excellent
cresol	excellent		

Combination Traps

Oxygen/Moisture Traps

Oxygen/moisture adsorbents team up to give you two functionalities in the same trap. Unlike some oxygen/moisture traps, these traps are disposable.

Consider the safety, performance, and cost advantages of Agilent capillary-grade oxygen/moisture traps (OT3) compared to heated, catalytic traps.

- Optimized for maximum surface area and capacity
- Leak-free, one-piece design (tested to 2000 psi)
- Bed material treated with ultra-high purity helium
- Filter design: prevents channeling, promotes efficient scrubbing

In addition to inert gases (nitrogen, helium, argon, and krypton), the Agilent OT3 Trap treats streams of hydrogen, alkanes, alkenes, aliphatic hydrocarbon gases, low boiling aromatics, carbon dioxide, carbon monoxide, and argon-methane.



Agilent OT3 trap

Oxygen/Moisture Traps (OT3 Series)

Description	Capacity	Efficiency	Size (cc)	1/8 in Part No.	1/4 in Part No.
OT3 Trap	500 mL O ₂ 2 g H ₂ O	< 15 µg/L	100	OT3-2	OT3-4
Trap Mounting Clips					
Mounting clip				MC-1	MC-1

HOW DOES IT WORK?



The Agilent OT3 Trap contains a highly active, metal-containing, scrubbing material in an inert, aluminum body.

Hydrocarbon/Moisture Traps

- Replace most mixed bed traps supplied by GC manufacturers
- Mounting panel

Hydrocarbon/Moisture Traps (HMT Series)

Description	Size (cc)	1/8 in Part No.	1/4 in Part No.
Hydrocarbon/Moisture Trap	200	HMT200-2	HMT200-4
Mounting Clips			
Mounting clip		MC-1	MC-1

Combination Traps for Chemical Ionization MS

Description	Fitting (in)	Part No.
Chemical Ionization for MS*	1/8	G1999-80410

*Isobutane or methane applications only

Universal/External Split Vent Trap

- Protects lab from contaminants released by split injection systems
- Stops environmental pollution by trapping and eliminating a broad range of contaminants
- Easy to change
- Comes with three packs of replacement cartridges

Universal/External Split Vent Trap

Description	Part No.
Universal/external split vent trap with 3 cartridges, 1/8 in Swagelok fitting	RDT-1020
Replacement cartridges, 3/pk	RDT-1023



Hydrocarbon/Moisture trap



Split vent trap and cartridges, RDT-1020

TIPS & TOOLS

Remember to replace split vent cartridge every six months.



ADM Flow Meters

ADM flow meters allow most gas measurements with the touch of only one button – turn it on, and the instrument provides continuous, hands-free flow readings. Measure column, detector, and carrier gas flows without making any adjustments. ADM flow meters are ideal for measuring gas streams with a changing gas composition. For example, if gas flow is measured from a digestion system, concentration changes in methane, carbon dioxide, and oxygen will not affect accuracy.

All ADM flow meters are battery powered and field-portable. Agilent calibrates each instrument to 5-point, NIST-traceable standards to ensure the highest available accuracy. The ADM family measures flow volumetrically, so you don't have to make adjustments when changing from one gas to another.



ADM 1000

ADM 1000

- Accuracy $\pm 3\%$
- Operating temperature range – 0 to 45 °C for the instrument, -70 to 135 °C for the tubing
- Calibration – traceable to NIST primary standards
- Real-time, split ratio measurement
- CE mark certified
- Measures flow rates from 0.5 to 1000 mL/min
- Split ratios – compare the ratio from one gas measurement to another (i.e., injection port split ratios)



ADM 2000

ADM 2000

In addition to the features of the ADM 1000, the ADM 2000 includes:

- Mass flow measurements – measure flow rate, independent of atmospheric pressure and temperature (calculated)
- Data output through RS-232 port
- 9 V battery and AC power adapter (120 or 220 VAC)

ADM Flow Meters

Description	Flow Rate (mL/min)		Gases Measured*	Accuracy (%)	Power Supply	RS-232 Data Output	Part No.
	Low	High					
ADM 1000**	0.5	1000	All	± 3	9 V Battery	None	220-1170
ADM 2000**	0.5	1000	All	± 3	Battery or 120 VAC	Yes	220-1171-U
ADM 2000E**	0.5	1000	All	± 3	AC Adapter, 220 V	Yes	220-1171-E
Carrying Case for ADM							907-0056

* $\pm 3\%$ or ± 0.2 mL/min, whichever is greater with a flow rate of 0.5-1,000 mL/min

**Non-corrosive gases only

Flow Meters

Precision Gas Flow Meter

Agilent's Precision Gas Flow Meter is the ultimate gas flow meter for chromatography applications. This handheld flow meter is highly accurate, reliable and incorporates industry leading performance. The inherent stability of the rugged, solid state components allows Agilent to provide the longest calibration interval on the market, all traceable to NIST standards.

- Highly accurate and reliable measurement of common carrier and fuel gases used in GC, including nitrogen, air, carbon dioxide, hydrogen, helium, and argon/methane
- Two year guaranteed calibration period traceable to NIST standards
- Measures flow based on gas viscosity properties with an accuracy of $\pm 0.8\%$ of reading + 0.2% of full scale
- Flow rate range from 5 to 500 mL/min
- Displays mass flow, volumetric flow, temperature, and pressure readings simultaneously
- Can be plumbed inline



Precision gas flow meter, 5067-0223

Precision Gas Flow Meter

Description	Part No.
Precision gas flow meter	5067-0223

TIPS & TOOLS

Ensure you are maximizing the inertness of your GC flow path with the Agilent Ultra Inert Poster – www.agilent.com/chem/Ulorder





Gas leak detector, G3388B

Gas Leak Detector

Gas leaks can cause detector noise and baseline instability, shorten column life and waste expensive carrier gas. Liquid leak detectors, although inexpensive, can contaminate your system. Agilent's G3388B Electronic Gas Leak Detector is an easy way to quickly identify leaks in your system and prevent system downtime.

- Detects thermal conductivity differences
- Audible and visual alerts
- Minimum detection limit – 0.0005 mL/min hydrogen and helium
- Lightweight – only 105 g
- Small – roughly 50 (w) x 19.5 (d) x 111 (h) mm
- Rechargeable Lithium Ion Battery with over 5 hours of life
- Includes a USB cable for battery charging
- One year warranty from Agilent

Gas Leak Detector

Description	Part No.
Handheld electronic gas leak detector	G3388B

G3388A Replacement Parts

Description	Part No.
Replacement filter tip	5067-0218
Replacement battery	5067-0219
Replacement power supply	5067-0220



TIPS & TOOLS

For more information about the Gas Leak Detector, visit www.agilent.com/chem/leakdetector

Gas Cylinder Regulators, U.S. Only

To plumb your system properly, select one of Agilent's economical brass regulators and the proper gas purification devices from our newly expanded product offering. These regulators and our broad spectrum of in-line filters, combination traps, and gas purification systems are an excellent combination to plumb your systems. Our new gas purification selection guide and diagrams will help you determine which products can be used with the regulators below.



Brass body regulator

Brass Body, Dual Stainless Steel Diaphragms

Specifications

Max inlet pressure	3000 psig
Operating temperature range	-40 °F to 165 °F
Inlet-outlet port	1/4 in, MNPT
Outlet valve	1/4 in, MNPT 2 1/2 in dual-scale gauges CGA-346, 350, 340, 580, 590 Internal self-reseating relief valve
Delivery pressures	1 to 125 psig
Weight	5.6 lb

Materials of Construction



Brass Body, Two-Stage Stainless Steel Diaphragms, 1/8 in, U.S. Only*

Description	Part No.
CGA 346, 125 psig max (8.6 bar), Breathing Air	5183-4641
CGA 350, 125 psig max (8.6 bar), H ₂ , Ar/Me	5183-4642
CGA 540, 125 psig max (8.6 bar), O ₂	5183-4643
CGA 580 Regulator, 125 psig max (8.6 bar), He, Ar, N ₂	5183-4644
CGA 590, 125 psig max (8.6 bar), Industrial Air	5183-4645

*For 1/4 in tubing, purchase a 1/4 in adapter, U.S. only



Connector (Swagelok-style to female NPT),
0100-0118



Connector (Swagelok-style to female NPT),
0100-0119

Connectors (Swagelok to Female NPT)

Description	Unit	Part No.
1/8 in (A) x 1/4 in (B) connector, brass (included with brass regulators)	1/ea	0100-0118
1/4 in (A) x 1/4 in (B) connector, brass*	1/ea	0100-0119
PTFE tape, industrial roll		0460-1266

*Required for plumbing 1/4 in tubing to regulators

Cylinder Wall Bracket

Description	Part No.
Cylinder wall bracket with strap & chain (cylinder size up to 14 in, 35 cm)	5183-1941



Cylinder wall bracket, 5183-1941



Kits, Fittings, Tools and Accessories

GC Installation Kits

Agilent Installation Kits for GC are designed to provide you with the essential items necessary for a successful installation while providing a substantial cost saving over individual purchases.

GC Installation Kit with Gas Purifiers

Description	Unit	Part No.
GC Installation Kit with Gas Purifiers		19199N
Gas Clean Filter Kit, 1/8 in		CP736530
Snoop, 8 oz (236 mL) bottle		9300-0311
1/8 in brass nut and ferrule set	20/pk	5080-8750
Copper tubing, 1/8 in, 50 ft		5180-4196
1/8 in tee, brass	2/pk	5180-4160
1/8 in cap, brass	6/pk	5180-4121
Universal/external split vent trap with 3 cartridges		RDT-1020
Tubing Cutter		8710-1709



Gas Clean Filters



Low dead volume tee, 5180-4160



1/8 in brass cap, 5180-4121



GC Installation Kit with Tools (no gas purifiers),
19199M

GC Installation Kit with Tools (no gas purifiers)

Description	Unit	Part No.
GC Installation Kit with Tools (no gas purifiers)		19199M
Snoop, 8 oz (236 mL) bottle		9300-0311
1/8 in brass nut and ferrule set	20/pk	5080-8750
Copper tubing, 1/8 in, 50 ft, precleaned		5180-4196
1/8 in tee, brass	2/pk	5180-4160
Tubing cutter, 1/8 to 5/8 in od tubing		8710-1709
1/8 in cap, brass	6/pk	5180-4121
Nut driver, 7 mm		8710-1217
Screwdriver, Torx T10		5182-3466
Screwdriver, Torx T20		5182-3465
Open end wrench, 1/4 and 5/16 in		8710-0510
Open end wrench, 7/16 and 9/16 in		8710-0803
Open end wrench, 7/16 and 3/8 in		8710-0972
Wrench, 1/2 and 7/16 in		8710-0806

GC Basic Installation Kit

Description	Part No.
GC Basic Installation Kit	5182-3453
Includes copper tubing, column nuts, a gas trap for the carrier gas, and five wrenches	

Tubing

Description	OD (in)	ID (mm)	Length	Part No.
Precleaned Copper tubing	1/8	2.1	50 ft	5180-4196
Precleaned Copper tubing	1/4	4.83		3700014600
Precleaned Copper tubing	1/8	2.1	12 ft	5021-7107
Copper tubing	1/16	3.25	50 ft	AL30509
Pretreated 316 stainless steel tubing	1/8	2.1	25 m	CP4026
Pretreated 316 stainless steel tubing			20 ft	7157-0210
Pretreated 316 stainless steel tubing			10 m	CP4025
Pretreated 316 stainless steel tubing			5 m	CP4024
Pretreated 316 stainless steel tubing	1/4	4.3	25 m	CP4032
Pretreated 316 stainless steel tubing			5 m	CP4030
Pretreated 316 stainless steel tubing			1 m	CP4013
PFA tubing	1/16	0.76	25 ft	AL45734

Fittings

Nuts, Front and Back Ferrule Sets

Description	Unit	Brass	Stainless Steel
1/16 in	10/pk		5180-4149
1/8 in	20/pk	5080-8750	5080-8751
1/4 in	20/pk	5080-8752	5080-8753

Nuts

Description	Unit	Brass	Stainless Steel
1/16 in, male nut	10/pk	SWB1021	5180-4102
1/16 in	1/ea		0100-0053
1/8 in	10/pk	5180-4103	5180-4104
1/8 in	1/ea	0100-0058	0100-0057
1/4 in	10/pk	5180-4105	5180-4106

Front Ferrules

Description	Unit	Brass	Stainless Steel
1/16 in	10/pk		5180-4108
1/4 in	1/ea	2869463500	
1/16 in, Valco one piece	10/pk		5181-1292
1/8 in	10/pk	5180-4109	5180-4110
1/4 in	10/pk	5180-4111	SWSS4031



Brass nut and ferrule set, 5080-8750



Stainless steel front ferrules, 5180-4108



Front ferrules, stainless steel, 5181-1292



Front ferrules, 5180-4109



Front ferrules, 5180-4111



Back ferrules, 5180-4115



Back ferrules, 5180-4117



1/8 in brass cap, 5180-4121



1/4 in brass cap, 5180-4120



1/8 in plug, 5180-4124



1/4 in plug, 5180-4125

Back Ferrules

Description	Unit	Brass	Stainless Steel
1/16 in	10/pk	5180-4113	5180-4114
1/8 in	10/pk	5180-4115	5180-4116
1/4 in	10/pk	5180-4117	SWSS4041

Caps

Description	Unit	Brass
1/8 in	6/pk	5180-4121
1/4 in	6/pk	5180-4120

Plugs

Description	Unit	Brass
1/8 in	6/pk	5180-4124
1/8 in	1/ea	0100-0071
1/6 in	1/ea	0100-1315
1/4 in	6/pk	5180-4125

Blanking Nut

Description	Unit	Stainless Steel
1/16 in	1/ea	01080-83202



Stainless steel blanking nut, 01080-83202

Adapter

Description	Unit	Brass
1/8 in x 1/8 in	1/ea	0100-0420



Brass adapter, 0100-0420

Hose Connector

Description	Unit	Brass
1/16 in	10/pk	5180-4148



Low dead volume tee, 0100-0782

Tees

Description	Unit	Brass	Stainless Steel
1/16 in	1/ea	0100-0680	0100-0782
1/8 in	1/ea	0100-0090	0100-0542
	2/pk	5180-4160	
1/8 in, for O ₂ gas mix	1/ea		0100-0542
1/4 in	1/ea	0100-0088	0100-0089
	2/pk	5180-4129	
1/6 in, low dead volume	1/ea		0100-0969



Stainless steel tee, 0100-0542



Low dead volume tee, 5180-4160



Brass cross, 0100-0161



Brass cross, 0100-0985



Brass union, 0100-1316



Stainless steel union, 0100-0124



1/8 in brass union, 5180-4127



1/4 in brass union, 5180-4128



ZDV union with fittings, 0100-0900

Crosses

Description	Unit	Brass
1/8 in	1/ea	0100-0161
1/8 in	1/ea	0100-0996
1/4 in	1/ea	0100-0985

Elbows

Description	Unit	Brass
1/8 in	1/ea	0100-0091
1/8 in	1/ea	0100-0092

Unions

Description	Unit	Brass	Stainless Steel
1/16 in	1/ea	0100-1316	0100-0124
1/8 in	2/pk	5180-4127	
	1/ea		0100-0126
1/4 in	2/pk	5180-4128	
	1/ea		0100-0128

Zero Dead Volume Unions

Description	Unit	Stainless Steel
1/16 in	1/ea	0100-0900

Bulkhead Unions

Description	Unit	Brass	Stainless Steel
1/8 in	1/ea	0100-0132	0100-0133

Connectors (Swagelok to Male NPT)

Description	Unit	Brass	Stainless Steel
1/16 in (A) x 1/4 in (B)	1/ea		CP741648
1/8 in (A) x 1/4 in (B)	2/pk	5180-4143	
1/8 in (A) x 1/8 in (B)	1/ea	0100-0110	0100-0111
1/4 in (A) x 1/4 in (B)	1/ea	0100-0208	0100-1189
	2/pk	5180-4145	



Connector (Swagelok-style to male NPT), 5180-4143



Connector (Swagelok-style to male NPT), 5180-4145



Connector (Swagelok-style to female NPT), 0100-0118



Connector (Swagelok-style to female NPT), 0100-0119

Connectors (Swagelok to Female NPT)

Description	Unit	Brass	Stainless Steel
1/8 in (A) x 1/4 in (B)	1/ea	0100-0118	SWSS20074
1/4 in (A) x 1/4 in (B)*	1/ea	0100-0119	

*Required for plumbing 1/4 in tubing to regulators

Reducing Unions

Description	Unit	Brass	Stainless Steel
1/16 in x 1/8 in	2/pk	5180-4130	
	1/ea		0100-0241
1/8 in x 1/4 in	2/pk	5180-4131	
	1/ea		0100-0121



Reducing union, 5180-4130



Reducing union, 5180-4131



Reducing union, 0100-0241



Reducing union, 0100-0121



Reducer, 5180-4135



Reducer, 5180-4134



Front ferrules, 5180-4109



Front ferrules, 5180-4111



Back ferrules, 5180-4115



1/4 in brass cap, 5180-4120



1/8 in brass cap, 5180-4121



1/8 in plug, 5180-4124



1/8 in brass union, 5180-4127



1/4 in brass union, 5180-4128



Low dead volume tee, 5180-4160

Reducers

Description	Unit	Brass	Stainless Steel
1/8 in (A) x 1/4 in (B)	2/pk	5180-4135	
1/6 in (A) x 1/8 in (B)	1/ea		0100-0073
1/4 in (A) x 1/8 in (B)	2/pk	5180-4134	

Fittings Kit

Description	Unit	Part No.
Fittings Kit: Includes items below		5180-4161
1/8 in nut, brass	10/pk	5180-4103
1/4 in nut, brass	10/pk	5180-4105
1/8 in front ferrule, brass	10/pk	5180-4109
1/4 in front ferrule, brass	10/pk	5180-4111
1/8 in back ferrule, brass	10/pk	5180-4115
1/4 in back ferrule, brass	10/pk	5180-4117
1/4 in cap, brass	6/pk	5180-4120
1/8 in cap, brass	6/pk	5180-4121
1/8 in plug, brass	6/pk	5180-4124
1/4 in plug, brass	6/pk	5180-4125
1/8 in union, brass	2/pk	5180-4127
1/4 in union, brass	2/pk	5180-4128
1/8 in tee, brass	2/pk	5180-4160
1/4 in tee, brass	2/pk	5180-4129
1/8 x 1/4 in reducing union, brass	2/pk	5180-4131
1/4 in (A) x 1/8 in (B) reducer, brass	2/pk	5180-4134
1/8 in (A) x 1/4 in (B) reducer, brass	2/pk	5180-4135

Tools

General Laboratory Tool Kit

The general laboratory tool kit includes the following items:

- Toolbox
- Flashlight
- 8 in bastard file
- 6 in adjustable wrench
- 12 in adjustable wrench for use with regulator
- No. 1 pt, 3 in Pozidriv shaft, fits no. 2-4 screws
- No. 2 pt, 4 in Pozidriv shaft, fits no. 5-10 screws
- Flathead screwdriver, 2 in steel shaft, 1/8 in blade
- Flathead screwdriver, 4 in steel shaft, 1/4 in blade
- Hex key set, 1.5, 2, 2.5, 3, 4, 5, and 6 mm keys
- 6 in long jaw needle nose pliers with side cutters
- Three open-end wrenches (1/4 x 5/16 in, 1/2 x 9/16 in, 7/16 x 3/8 in)
- Snoop-liquid leak detector
- PTFE tape

Description	Part No.
General laboratory tool kit	5180-4162

Wrenches

Description	Part No.
Open end wrench, 1/4 and 5/16 in	8710-0510
Wrench, 1/2 and 7/16 in	8710-0806
Open end wrench, 7/16 and 9/16 in	8710-0803
Open end wrench, 7/16 and 3/8 in	8710-0972
Adjustable wrench, 12 in, for use with regulators	8710-1712
Open end wrench, 9/16 and 5/8 in	8720-0010
Open end wrench, 1/2 and 9/16 in	8720-0025
Open end wrench, 14 mm	8710-1924
Open end wrench, 12 mm, 116 mm long	8710-1841
Open end wrench, 4 mm	8710-1534

LC Tool Kits

Description	Part No.
HPLC system tool kit	G4203-68708
Compact tool kit	G4296-68715

Screwdrivers

Description	Part No.
Screwdriver, 3 in Pozidriv shaft No. 1 pt	8710-0899
Screwdriver, 4 in Pozidriv shaft No. 2 pt	8710-0900
Screwdriver, Torx T10	5182-3466
Screwdriver, Torx T20	5182-3465



General laboratory tool kit, 5180-4162



HPLC system tool kit, G4203-68708

Pliers and Tweezers

Description	Part No.
Needle nose pliers, pointed serrated jaws	8710-0004
Tweezers, 4-3/4 in long	8710-0007
Truarc pliers	8710-0018

Tube Cutters and Replacement Blades

Description	Unit	Part No.
Precision tubing cutter for 1/16 in stainless steel tubing		5190-1442
Hi-duty tubing cutter, 1/8 to 1-1/8 in od tubing		8710-1707
Hi-duty tubing cutter blades	5/pk	8710-1708
Tubing cutter, 1/8 to 5/8 in od tubing		8710-1709
Plastic tubing cutter		8710-1930
Blades for plastic cutter, 5/pk	5/pk	8710-1931



Plastic tubing cutter, 8710-1930

Hex Keys

Description	Part No.
Hex key set: 1.5, 2, 2.5, 3, 4, and 5 mm keys, 1090A (5880/90A)	8710-0641
Hex key, 4 mm, 15 cm long, T-handle	8710-2392
Hex key, 3 mm, 12 cm long, straight handle	8710-2411
Hex key, 2.5 mm, 15 cm long, straight handle	8710-2412
Hex key, 1.5 mm, 10 cm long, straight handle	8710-2393
Hex key, 9/64 in, 15 cm long, T-handle	8710-2394
Hex key, 4.0 mm, 10 cm long, straight handle	5965-0027
Hex key, 2.5 mm, 10 cm long, straight handle	5965-0028
Tool kit hex keys, Rheotool*	5064-8211
Includes 3 hex keys, 4 mm, 1.5 mm, and 9/64 in, with straight or T-handle plus Rheotool	



Hex keys, Rheotool, 5064-8211

*These tools are recommended for easier repair and maintenance of LC modules.



GC Column Accessories

Capillary Column Installation Kit

The Capillary Column Installation Kit contains:

- Diamond-tipped pencil
- 20x magnifier
- Ferrule removal tool
- Septum removal tool
- Refillable 2 oz bottle of Snoop

Description	Part No.
Capillary Column Installation Kit with diamond-tipped cutting pencil	430-2000



Column installation kit, 430-2000

Capillary Column Rinse Kit

This kit makes solvent rinsing easy! Solvent rinsing removes many contaminants that accumulate in columns. The contaminants are removed by passing solvents through the column. Only bonded and cross-linked phase columns should be rinsed, or permanent damage to the column will result.

Description	Part No.
Capillary Column Rinse Kit	430-3000



Column rinse kit, 430-3000

TIPS & TOOLS

View the latest Agilent J&W GC column focused applications, products and educational resources at www.agilent.com/chem/mygccolumns

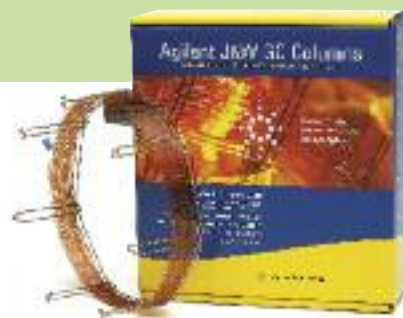



Fused silica tubing cutters

Fused Silica Tubing Cutters

We offer a conveniently designed, pencil-shaped tool and a ceramic wafer that allow you to make clean and easy cuts in fused silica, glass and aluminum-clad capillary columns.

Description	Part No.
Diamond-tipped column cutting pencil	420-1000
Ceramic wafer column cutter, 4/pk	5181-8836
Column cutter with rotating diamond blade	5183-4620
Replacement diamond blade (for 5183-4620)	5183-4621

Column Baskets and Hangers

Description	Part No.
13 cm, 5 in basket for 6850 capillary columns	19091-80060
Column hanger for 5 in basket	G2630-80800
Column hanger clip kit for 7 in basket	G1530-61580
Column hanger for 6890, 5890, 5880A	1460-1914



Column cutting tool, 5183-4620

Miscellaneous Tools

Ferrule Tools

Remove ferrules stuck inside fittings. Screw the stainless steel ferrule tool into the ferrule and pull it out. Use the smaller capillary ferrule tool for capillary column ferrules (0.32 mm id column and smaller). The megabore ferrule tool is used for megabore ferrules. The liner tool can be used to remove polyimide and tubing from inside a megabore liner. The column ferrule installation tool positions a ferrule onto a capillary column for proper installation.

Description	Part No.
Capillary ferrule tool	RFT-2500
Megabore ferrule tool	RFT-5300
Column ferrule installation tool	19251-80680
MS interface column installation tool	G1099-20030



Capillary and megabore ferrule tool

20x Magnifier

Examine column ends for proper cuts. Jagged, rough, or non-perpendicular cuts negatively affect chromatographic performance.

Description	Part No.
20x Magnifier	430-1020



Magnifier, mirror, microprobes

Microprobes

Hardened stainless steel probes remove septum and ferrule pieces stuck in fittings. Five different styles give you all of the angles necessary for getting into those hard-to-reach places.

Description	Part No.
Microprobes	RMP-5005

Mirror

Inspect injection ports, the inside of fittings, and other hard-to-reach places.

Description	Part No.
Mirror	707-0027

Snoop



Snoop

Leak test most pressurized gas systems. We recommend that leak detecting solutions be used with care where there is any possibility of the fluid being aspirated into gas flow streams supplying the column or detector. This squeezable bottle comes with a "Snooper Tube" extendable up to 12 in (30 cm). Electronic leak detectors are preferred. In their absence, a volatile nonreactive solvent like isopropanol may be used. Use caution to avoid aspiration of materials such as Snoop into the column.

Description	Part No.
Snoop, 8 oz (236 mL) bottle	9300-0311
Snoop, 1 gallon bottle	460-1002



Injection port cleaning kit, 480-0003

Injection Port Cleaning Kit

If changing the liner and trimming the column does not remove contamination from your injection port, you probably need to clean and flush your injection port. Three stainless steel brushes and a scraper are the ideal tools for removing sample residue and septum particles. The stainless steel brushes have diameters of 5 mm, 1/4 in, and 3/8 in.

Description	Part No.
Injection Port Cleaning Kit	480-0003



Septum tool with knurled handle, 450-1000

Miscellaneous Injection Port Tools

Description	Part No.
Septum tool, knurled handle	450-1000
Ferrule removal tool	440-1000
Capillary inlet cleaning wires, 5/pk	5180-4153
Cotton swabs, 100/pk	5080-5400



Capillary inlet cleaning wires, 5180-4153

FID Cleaning Kit

This easy-to-use maintenance kit improves sensitivity, reduces noise, and decreases detector spiking.

Description	Part No.
FID cleaning kit	9301-0985



FID cleaning kit, 9301-0985

12-Piece File Set

This 12-piece file set scores glass, removes burrs from metal tubing, and cleans threads. The files are 5-1/2 in long.

Description	Part No.
12-Piece File Set	RSF-1200



3200P standard pH meter, G4383A

User-friendly control panel simplifies your measurements and ensures accurate results, regardless of technical knowledge or skill level.

Every Agilent Meter is backed by our 3-year replacement guarantee.

Electrochemistry Meters, Electrodes, and Solutions

Analyst-friendly features optimize your measurements and ensure accuracy

Your rapidly changing work environment demands speed and productivity without jeopardizing results. That is why all Agilent meters and electrodes are designed for easy operation, even by non-technical users, while still producing the most reliable readings.

- Unique electrode reference system, backed by our qualified material and manufacturing process, delivers fast, reliable response during meter operation
- Rugged design stands up to the toughest indoor and outdoor conditions
- High-endurance protective glass and multi-layer composite electrodes prevent breakage caused by frequent use, even in demanding environments

3200P pH Meter

3200P pH Meter Specifications*

Specifications		3200P
Range	pH	-2.000-20.000 pH
	mV	-1999.9-1999.9 mV
	Temperature	-5.0-110.0 °C
Resolution	pH	0.1/0.01/0.001 pH
	mV	0.1 mV
	Temperature	0.1 °C
Accuracy	pH	±0.002 pH
	mV	±0.03% FS
	Temperature	±0.1 °C
Temperature compensation		Manual/Auto -5.0-110.0 °C
Power		Universal AC power adapter 100 V-240 V, 50/60 Hz**
Dimension (LxDxH) [mm]		190×190×105
Weight (kg)		1

*EC Print software for easy and direct printing and EC Firmware software are available for free download at www.agilent.com/chem/phmeters

**Shipped with meter



3200P standard pH meter, G4383A

3200M Multi-parameter Meter

Simultaneously measure pH/pX, ion concentration, ion electrode potential (mV), conductivity (TDS, salinity), DO (concentration and saturation), temperature, and more.

3200M Multi-parameter Analyzer Specifications*

Specifications		3200M	
Range	pH	-2.000-20.000 pH	
	pX	0.000-14.000 pX	
	mV	-1999.9-1999.9 mV	
	Conductivity	0.000 μ S/cm-2000 mS/cm	
	Resistivity	5.00 Ω .cm-100.0 M Ω .cm	
	TDS	0.000 mg/L-1000 g/L	
	Salinity	0.00%-8.00% (Chinese version) 0.0-80.0 g/L (English version)	
	DO	0-45.00 mg/L	
	DO saturation	0.0-300.0%	
	Ion concentration		0-19990
			-5.0-110.0 $^{\circ}$ C
	Temperature		-5.0-110.0 $^{\circ}$ C
Resolution	pH/pX	0.1/0.01/0.001 pH/pX	
	mV	0.1 mV	
	Ion concentration	Four effective digits (Scientific notation)	
	DO	0.01 mg/L	
	DO saturation	0.1%	
	Temperature	0.1 $^{\circ}$ C	

*EC Print software for easy and direct printing and EC Firmware software are available for free download at www.agilent.com/chem/phmeters



3200M multi-parameter meter, G4387A

(Continued)



3200M Multi-parameter Analyzer Specifications*

Specifications		3200M
Accuracy	pH/pX	±0.002 pH/pX;pXII:± 0.005 pX
	mV	±0.03% FS
	Ion concentration	±0.3%
	Conductivity	±0.5% FS
	Resistivity	±0.5% FS
	TDS	±0.5% FS
	Salinity	±0.1%
	DO	±0.10 mg/L
	DO saturation	±2.0%
	Temperature	±0.1 °C
Power	Universal AC power adapter 100 V-240 V, 50/60 Hz**	
Dimensions (LxDxH) [mm]	190×190×105	
Weight (kg)	1	1

*EC Print software for easy and direct printing and EC Firmware software are available for free download at www.agilent.com/chem/phmeters

**Shipped with meter

Cell Constant and Correspondent Measuring Range

Cell constant (K) (cm ⁻¹)	0.001	0.01	0.1	1.0	10.0	100
Measuring range for solutions	0.000 µS/cm- 1.999 µS/cm	0.000 µS/cm- 19.99 µS/cm	0.200 µS/cm- 199.9 µS/cm	2.00 µS/cm- 19.99 mS/cm	20.0 µS/cm- 199.9 mS/cm	200 mS/cm- 2000 mS/cm

3200I Ion Meter

When matched with an ion-selective electrode and reference electrode, ion meters can measure corresponding electrode potential (mV), pX, and ion concentration.

3200I Ion Meter Specifications*

Specifications		3200I
Range	pH	-2.000-20.000 pH
	pX	0.000-14.000 pX
	mV	-1999.9-1999.9 mV
	Ion concentration	0-19990
	Concentration unit	mol/L, mmol/L, g/L, mg/L, µg/L (Chinese version) mol/L, mg/L, %, mg/L, µg/L (English version)
	Temperature	-5.0-110.0 °C
Resolution	pX	0.1/0.01/0.001 pH/pX
	mV	0.1 mV
	Ion concentration	Four effective digit (Scientific notation)
	Temperature	0.1 °C
Accuracy	pX	±0.002 pH/pX;pXI: ±0.005 pX
	mV	±0.03% FS
	Ion concentration	±0.3%
	Temperature	±0.1 °C
Power		Universal AC power adapter 100 V-240 V, 50/60 Hz**
Dimension (LxDxH) [mm]		190x190x105
Weight (kg)		1

*EC Print software for easy and direct printing and EC Firmware software are available for free download at www.agilent.com/chem/phmeters

**Shipped with meter



3200I ion meter, G4386A



3200C conductivity meter, G4384A

3200C Conductivity Meter

Measure conductivity, resistivity, total dissolved solid (TDS), salinity, and present solution temperature.

3200C Conductivity Meter Specifications*

Specifications	3200C	
Range	Conductivity	0.000 μ S/cm-2000 mS/cm
	Resistivity	5.00 Ω .cm-100.0 M Ω .cm
	TDS	0.000 mg/L-1000 g/L
	Salinity	0.00%-8.00% (Chinese version) 0.0-80.0 g/L (English version)
	Temperature	-5.0-110.0 $^{\circ}$ C
Resolution	Conductivity	Four effective digital, and the lowest level is 0.001 μ S/cm
	Temperature	0.1 $^{\circ}$ C
Accuracy	Conductivity	\pm 0.5% FS
	Resistivity	\pm 0.5% FS
	TDS	\pm 0.5% FS
	Salinity	\pm 0.1%
	Temperature	\pm 0.1 $^{\circ}$ C
Cell constant	0.001, 0.01, 0.1, 1.0, 10, 100 cm^{-1}	
Compensation range of cell constant	\pm 20% of Standard constant value	
Temperature compensation range	0-50.0 $^{\circ}$ C	
Conductivity and TDS standard temperature	25.0 $^{\circ}$ C	
Salinity standard temperature	18.0 $^{\circ}$ C	
Power	Universal AC power adapter 100 V-240 V, 50/60 Hz**	
Dimension (LxDxH) [mm]	190x190x105	
Weight (kg)	1	

*EC Print software for easy and direct printing and EC Firmware software are available for free download at www.agilent.com/chem/phmeters

**Shipped with meter

3200D Dissolved Oxygen Meter

Membrane electrode measures DO concentration and saturation of water solutions.

3200D Dissolved Oxygen Meter Specifications*

Specifications	3200D	
Range	DO	0-45.00 mg/L
	DO saturation	0.0-300.0%
	Temperature	-5.0-110.0 °C
Resolution	DO	0.01 mg/L
	DO saturation	0.1%
	Temperature	0.1 °C
Accuracy	DO	±0.10 mg/L
	DO saturation	±2.0%
	Temperature	±0.1 °C
Temperature compensation	Automatic: 0.0-45.0 °C	
Standard temperature	20±1 °C	
Salinity calibration	0.0-50.0 g/L	
Barometric pressure calibration	60.0-110.0 kPa	
Power	Universal AC power adapter 100 V-240 V, 50/60 Hz**	
Dimension (LxDxH) [mm]	190×190×105	
Weight (kg)	1	

*EC Print software for easy and direct printing and EC Firmware software are available for free download at www.agilent.com/chem/phmeters

**Shipped with meter



3200D dissolved oxygen meter, G4385A

Agilent Electrochemistry Meters: rigorously evaluated for durability and safety

Our environmental test specifications ensure that Agilent Electrochemistry Meters will be rugged performers in your lab, just like Agilent columns and instruments.

Environmental Test Specifications

Operating ambient temperature	0-50 °C
Operating relative humidity	5-95%, no condensation
Storage temperature	Meter: -40-70 °C; Electrode: -15-55 °C
Vibration and shock	Instrument test and package test



Module Specifications

Type/Model	Key Industries/Applications	Measurements	Details
Standard pH Meter (3200P)	<ul style="list-style-type: none"> Pharmaceutical Food safety Biological agriculture Environmental Water quality 	<ul style="list-style-type: none"> Acid and alkali levels Electrode potential (mV) values of relevant ions 	<ul style="list-style-type: none"> G4383A for 3200P meter only G4391A for basic package with electrode, electrode holder and buffer G4392A for kit with triode combination electrode, electrode holder and buffer
Conductivity Meter (3200C)	<ul style="list-style-type: none"> Environmental Petrochemical Food safety Biological 	<ul style="list-style-type: none"> Conductivity Resistivity Total Dissolved Solids (TDS) Salinity Present solution temperature value 	<ul style="list-style-type: none"> G4384A for 3200C meter only G4393A for package with 3200C meter, electrode and electrode holder
Dissolved Oxygen (DO) Meter (3200D)	<ul style="list-style-type: none"> Environmental Sewage disposal Tap water source monitoring Food safety Aquaculture Beverage production Biological agriculture Scientific research 	<ul style="list-style-type: none"> Dissolved oxygen concentration Saturation of water solution 	<ul style="list-style-type: none"> G4385A for 3200D meter only G4395A for package with 3200D meter, electrode and electrode holder
Ion Meter (3200I)	<ul style="list-style-type: none"> Food safety Biological agriculture Petrochemical Environmental protection Scientific research Disease control 	<ul style="list-style-type: none"> Electrode potential (mV) values pX value and ion concentration 	<ul style="list-style-type: none"> G4396A for 3200I meter only G4396A for package with 3200I meter, pH electrode, electrode holder and buffer G4397A for fluoride ion package with 3200I meter, fluoride ion electrode and electrode holder and buffer
Multi-Parameter Meter (3200M)	<ul style="list-style-type: none"> Water quality Disease control Environmental protection Biological agriculture Scientific research 	<ul style="list-style-type: none"> Simultaneously measures pH/pX, ion concentration, ion electrode potential (mV), conductivity, Total Dissolved Solids (TDS), salinity, dissolved oxygen, and temperature 	<ul style="list-style-type: none"> G4378A for 3200M meter G4398A for 3200M meter, electrode, electrode holder and buffer

Module specifications

Agilent provides modules to fit your most challenging applications.

Module	Specifications	Benefits
3200P	Temperature: -5.0-110.0 °C	Compatible with a wide temperature range
3200C	Measuring mode: continuous/timed reading/auto-lock	Lets you perform a variety of measurements with one meter
3200D	Dot-matrix LCD	Fast interpretation of results
3200I		Easy for novices to use
3200M	Numeric operating keys	Simplified operation for all skill levels
3200P	Automatic identification for buffers	Choice of NIST and GB buffers
3200I	Impedance: $3 \times 10^{12} \Omega$	Choose from a wider range of electrodes for your sample
3200M	Accuracy of DO: ± 0.10 mg/L	Precise measurements and excellent temperature compensation provide outstanding DO accuracy
3200I	Provides Ion measurement modes for H ⁺ , Ag ⁺ , Na ⁺ , K ⁺ , NH ₄ ⁺ , Cl ⁻ , F ⁻ , NO ₃ ⁻ , BF ₄ ⁻ , CN ⁻ , Cu ²⁺ , Pb ²⁺ and Ca ²⁺	Easily exchanged electrodes (or ISEs) allow flexible multi-ion analysis
3200M	Different units can be switched freely	Automatic functions optimize measurements and ensure accurate results
	Measuring mode in ion concentration: direct reading, "Standard" addition, sample addition, GRAN plot addition	Convenience



3200EA electrode holder, G4389A

Wide range of Agilent electrodes help meet the needs of any application

Unlike single-layer breathable membrane electrodes, Agilent electrodes are made from multi-layered composite materials for extra durability. They also feature a specific barrier to protect the glass bubble against breakage.

What's more, the unique reference system on every Agilent electrode is backed by our uncompromising materials quality and manufacturing process – giving you fast response and high accuracy.

The electrodes shown here use universal connections, so you can use them interchangeably on Orion 3 star, 4 star meter, Hanna HI2221, and Mettler FE20pH.



P3211 pH combination electrode, 5190-3988

P3212 pH combination electrode, 5190-3989

P3214 pH combination electrode, 5190-3993

P3213 pH combination electrode, 5190-3992

P3311 pH triode combination electrode, 5190-3990

P3111 pH electrode, 5190-3991

pH P3211	pH P3212	pH P3214	pH P3213	pH P3311	pH P3111
<ul style="list-style-type: none"> • Combination electrode with glass body • Refillable • BNC connector • Glass bulb measuring tip 	<ul style="list-style-type: none"> • Combination electrode with PC body • Not refillable • BNC connector • Glass bulb measuring tip 	<ul style="list-style-type: none"> • Combination electrode with ABS body • Not refillable • BNC connector • Spear-tipped measuring tip 	<ul style="list-style-type: none"> • Combination electrode with PC body • Refillable • BNC connector • Flat measuring tip 	<ul style="list-style-type: none"> • Combination electrode with glass body • Refillable • BNC and miniDIN4 connector • Glass bulb measuring tip 	<ul style="list-style-type: none"> • Electrode with glass body • Not refillable • BNC connector • Glass bulb measuring tip

Recommended uses*

Industry	Sample	pH P3211	pH P3212	pH P3214	pH P3213	pH P3311	pH P3111
Drinks and dairy products	Milk	✓	✓			✓	✓
	Soy Sauce	✓	✓			✓	✓
	Beer	✓	✓			✓	✓
	Soft drinks (ice black tea)	✓	✓			✓	✓
Food and agricultural products	Compound fertilizer		✓				
	Jam						✓
	Meat			✓			
	Vegetables	✓	✓			✓	✓
	Waste	✓				✓	
Chemical reagents and electrolytes	Electroplate liquid	✓				✓	✓
Coatings, dyes, and latex	Suspended solid (soil)		✓				
Water	Tap water	✓	✓			✓	
	Drinking water (barreled water)						✓ (Static)
	Distilled water						✓ (Sealed)
Drug or biological samples	Protein sample/protein powder	✓	✓			✓	
Surface measurement	Droplet size of the sample				✓		
	Textiles				✓		
Cosmetics and viscous samples	Shampoo	✓				✓	✓
	Cosmetic paste	✓				✓	✓

*Laboratory test; for reference only



ORP8211 ORP electrode, 5190-3999

Recommended uses*

ORP8211	Oxygen Reduction Potential (ORP) measurement of: <ul style="list-style-type: none"> • Conventional water • Wastewater • Electroplate liquid • Biological samples
I9111	<ul style="list-style-type: none"> • Fluoride water samples • Surface water • Drinking water • Industrial effluent
I9121	<ul style="list-style-type: none"> • Ammonium/ammonia-containing water samples • River and lake water • Tap water • Environmental protection/sewage
I9131	<ul style="list-style-type: none"> • Conventional sodium water samples • Water treatment • Power plant • Industrial process control

*Laboratory test; for reference only

pH Electrode Specifications

Model	P3211	P3212	P3214	P3213	P3311	P3111
Measurement range	0-14 pH	0-14 pH	0-14 pH	0-14 pH	0-14 pH	0-14 pH
PTS	≥ 97%	≥ 97%	≥ 97%	≥ 97%	≥ 97%	≥ 98.5%
Response time	30s	30s	60s	60s	30s	60s
Temperature accuracy	–	–	–	–	± 0.5 °C	–
Electrode impedance	≤ 300 MΩ	≤ 300 MΩ	≤ 500 MΩ	≤ 500 MΩ	≤ 300 MΩ	≤ 250 MΩ
Reference type	Ag/AgCl	Ag/AgCl	Ag/AgCl	Ag/AgCl	Ag/AgCl	–
Liquid junction material	Ceramic	Porous polymer	Fiber	Fiber	Ceramic	–



ORP8211 ORP electrode,
5190-3999



I9111 Fluoride combination ISE,
5190-4002



I9121 Ammonia combination ISE,
5190-4004



I9131 Sodium combination ISE,
5190-4005

ORP8211 Oxidation Reduction Potential	I9111 Fluoride Combination ISE	I9121 Ammonia Combination ISE	I9131 Sodium Combination ISE
Combination electrode with glass body Refillable BNC connector	Combination electrode with PC body Refillable BNC connector	Combination electrode with PMMA body Refillable BNC connector	Combination electrode with glass body Refillable BNC connector

Ion Selective Electrode Specifications	I9111 Fluoride Combination ISE	I9121 Ammonia Combination ISE	I9131 Sodium Combination ISE
Concentration range	Saturation: -10^{-6} mol/L Saturation: -0.02 mg/L	$(10^{-1} - 10^{-6})$ mol/L	Saturation: -10^{-6} mol/L
Slope (25 °C)	$\geq 56 (10^{-5} - 10^{-1})$ mol/L	$\geq 55 (10^{-5} - 10^{-2})$ mol/L	$\geq 56 (10^{-5} - 10^{-1})$ mol/L
Response time	30s	180s	180s
Internal impedance	≤ 1 M Ω	≤ 1500 M Ω	≤ 250 M Ω
Reference type	Ag/AgCl	Ag/AgCl	Ag/AgCl

ORP8211 Oxidation Reduction Potential Electrode Specifications

Measurement range	± 1999 mV
Potential accuracy	263 ± 10 mV
Reference type	Ag/AgCl
Liquid junction material	Ceramic

R8111 Reference Electrode Specifications

Potential accuracy	± 4 mV
Internal impedance	≤ 1 k Ω
Reference type	Ag/AgCl
Liquid junction material	Ceramic
Reference filling solution	AgCl, 3 mol/L KCl

T7111 Automatic Temperature Compensation Probe Specifications

Measuring range	0-100 °C
Accuracy	± 0.3 °C 0-60 °C ± 1.0 °C 60-100 °C

D6111 Dissolved Oxygen Probe Specifications

Measuring range	0-20 mg/L
Zero oxygen current	1% FS (5 min)
Response time (90%)	30 s
Temperature accuracy	± 0.5 °C

Conductivity Probe Specifications

	C5111	C5112	C5113
Cell constant	1.0 ± 0.2	1.0 ± 0.2	0.1 ± 0.02
Measuring range	2-19990 μ S/cm	2-3000 μ S/cm	0.2-199.9 μ S/cm
Accuracy	$\pm 0.6\%$	$\pm 0.6\%$	$\pm 0.6\%$

All-in-one Packages

Description	Recommended Use	Part No.
Agilent 3200P Benchtop pH Meter Basic Package Includes:	Stable, accurate measurement of organic solution samples in fields such as scientific research, education, and chemical analysis	G4391A
Agilent 3200P benchtop pH meter		G4383A
Agilent 3200EA electrode holder		G4389A
P3211 pH combination electrode, includes 30 mL reference solution		5190-3988
T7111 ATC probe		5190-3998
pH buffer solutions, 4.01, 7.00, 10.01, NIST traceable, 250 mL, 3/pk		5190-0533*
pH buffer solutions, 4.00, 6.86, 9.18, GB traceable, 250 mL, 3/pk		5190-0534**
Agilent 3200P Benchtop pH Meter Package with 3-in-1 Electrode Includes:	Ordinary physical and chemical analysis in fields such as conventional water quality, education, and chemical analysis	G4392A
Agilent 3200P benchtop pH meter		G4383A
Agilent 3200EA electrode holder		G4389A
P3311 pH triode combination electrode, includes 30 mL reference solution		5190-3990
pH buffer solutions, 4.01, 7.00, 10.01, NIST traceable, 250 mL, 3/pk		5190-0533*
pH buffer solutions, 4.00, 6.86, 9.18, GB traceable, 250 mL, 3/pk		5190-0534**
Agilent 3200C Benchtop Conductivity Meter Basic Package Includes:	Best for applications such as conventional surface water, drinking water, environmental water testing, and process analysis	G4393A
Agilent 3200C benchtop conductivity meter		G4384A
Agilent 3200EA electrode holder		G4389A
C5111 conductivity probe		5190-3994
T7111 ATC probe		5190-3998
Agilent 3200C Benchtop Conductivity Meter Package for Pure Water Analysis Includes:	Low-conductivity sample measurement of distilled water, boiler water, and pure water in fields such as energy, pharmacy, biology, and food safety	G4394A
Agilent 3200C benchtop conductivity meter		G4384A
Agilent 3200EA electrode holder		G4389A
C5113 conductivity probe		5190-3996
T7111 ATC probe		5190-3998

*Default, if not specified otherwise

**For China customers only

(Continued)

All-in-one Packages

Description	Recommended Use	Part No.
Agilent 3200D Benchtop Dissolved Oxygen Meter Package Includes:	DO measurement of conventional water in applications such as environmental, monitoring, aquaculture, sewage treatment, drinking water and research	G4395A
Agilent 3200D benchtop dissolved oxygen meter		G4385A
Agilent 3200EA electrode holder		G4389A
D6111 DO probe, 30 mL bottle of DO filling solution		5190-3997
Agilent 3200I Benchtop Ion Meter Basic Package Includes:	pH measurement and ion analysis in fields such as scientific research, process analysis, biochemistry, and pharmacy (different ion, different electrode)	G4396A
Agilent 3200I benchtop ion meter		G4386A
Agilent 3200EA electrode holder		G4389A
T7111 ATC probe		5190-3998
pH buffer solutions, 4.01, 7.00, 10.01, NIST traceable, 250 mL, 3/pk		5190-0533*
pH buffer solutions, 4.00, 6.86, 9.18, GB traceable, 250 mL, 3/pk		5190-0534**
P3211 pH combination electrode, includes 30 mL reference solution		5190-3988
Agilent 3200I Benchtop Fluoride Ion Meter Package Includes:	Measurement of samples such as fluoride water, surface water, drinking water, and industrial effluent	G4397A
Agilent 3200I benchtop ion meter		G4386A
Agilent 3200EA electrode holder		G4389A
T7111 ATC probe		5190-3998
I9111 fluoride combination ISE, includes 30 mL reference solution		5190-4002
Agilent 3200M Benchtop Multi-Parameter Analyzer Package Includes:	pH, conductivity, and DO measurement; ion analysis in a wide range of fields (different ion, different electrode)	G4398A
Agilent 3200M benchtop multi-parameter analyzer		G4387A
Agilent 3200EA electrode holder		G4389A
P3211 pH combination electrode, includes 30 mL reference solution		5190-3988
T7111 ATC probe		5190-3998
pH buffer solutions, 4.01, 7.00, 10.01, NIST traceable, 250 mL, 3/pk		5190-0533*
pH buffer solutions, 4.00, 6.86, 9.18, GB traceable, 250 mL, 3/pk		5190-0534**
D6111 DO probe, 30 mL bottle of DO filling solution		5190-3997
C5111 conductivity probe		5190-3994

*Default, if not specified otherwise

**For China customers only

Electrochemistry Meters*

Description	Part No.
Agilent 3200P benchtop pH meter	G4383A
Agilent 3200C benchtop conductivity meter	G4384A
Agilent 3200D benchtop dissolved oxygen meter	G4385A
Agilent 3200I benchtop ion meter	G4386A
Agilent 3200M benchtop multi-parameter analyzer	G4387A
Accessories	
Agilent 3200SA stirrer	G4388A
Agilent 3200EA electrode holder	G4389A

*EC Print software for easy and direct printing and EC Firmware software are available for free download at www.agilent.com/chem/phmeters



3200SA stirrer, G4388A



P3211 pH combination electrode,
5190-3988



P3212 pH combination electrode,
5190-3989



P3311 pH triode combination
electrode, 5190-3990



P3111 pH electrode,
5190-3991



P3213 pH combination electrode,
5190-3992



P3214 pH combination electrode,
5190-3993



C5111 Conductivity probe,
5190-3994



C5112 Conductivity probe,
5190-3995



C5113 Conductivity probe,
5190-3996



D6111 DO probe,
5190-3997



T7111 ATC probe,
5190-3998



ORP8211 ORP electrode,
5190-3999



R8111 Reference electrode,
5190-4003



I9111 Fluoride combination ISE,
5190-4002



I9121 Ammonia combination ISE,
5190-4004



I9131 Sodium combination ISE,
5190-4005

Electrodes*

Description	Kit Contents	Part No.
P3211 pH combination electrode	Includes 30 mL reference solution	5190-3988
P3212 pH combination electrode		5190-3989
P3311 pH triode combination electrode	Includes 30 mL reference solution	5190-3990
P3111 pH electrode		5190-3991
P3213 pH combination electrode	Includes 30 mL reference solution	5190-3992
P3214 pH combination electrode		5190-3993
C5111 conductivity probe		5190-3994
C5112 conductivity probe		5190-3995
C5113 conductivity probe		5190-3996
D6111 DO probe	Includes 30 mL DO Filling Solution	5190-3997
T7111 ATC probe		5190-3998
ORP8211 ORP electrode	Includes 30 mL reference solution	5190-3999
R8111 reference electrode	Includes 30 mL reference solution	5190-4003
I9111 fluoride combination ISE	Includes 30 mL reference solution	5190-4002
I9121 ammonia combination ISE	Includes 30 mL reference solution	5190-4004
I9131 sodium combination ISE	Includes 30 mL reference solution	5190-4005

*All electrodes ship with a certificate of conformance and the certificate is also available online in the literature library

Chemicals*

Description	Amount	Part No.
pH buffer solutions, 4.01, 7.00, 10.01, NIST traceable	3 x 250 mL	5190-0533
pH buffer solutions, 4.00, 6.86, 9.18, GB traceable	3 x 250 mL	5190-0534
pH buffer, 4.01	3 x 250 mL	5190-0535
pH buffer, 10.01	3 x 250 mL	5190-0536
pH buffer, 7.00	3 x 250 mL	5190-0537
pH buffer, 4.00	3 x 250 mL	5190-0538
pH buffer, 6.86	3 x 250 mL	5190-0539
pH buffer, 9.18	3 x 250 mL	5190-0540
Ammonia electrode membrane, 5 pieces		5190-0543
Ammonia Reference Solution	3 x 30 mL	5190-0544
Reference solution, pH	3 x 250 mL	5190-0545
Sodium ISE Reference Solution	3 x 30 mL	5190-0546
DO filling solution	3 x 30 mL	5190-0547
DO membrane sleeve, 3 pieces	3 x 30 mL	5190-0548

Accessories

Power adapter, E15WCP1-090100SPA	5185-8389
B620 stirring bar	G4388-27000
BNC-50J short circuit plug	G4383-40000
ATC temperature diagnostic tool	5185-8390
Conductivity diagnostic tool	5185-8391

*Certificates of analysis ship with this product and are also available online in the literature library.



Agilent reference and filling solutions



Ammonia electrode membrane, 5190-0543



Power adapter, 5185-8389



B620 stirring bar, G4388-27000



BNC-50J short circuit plug, G4383-40000



ATC temperature diagnostic tool, 5185-8390



Conductivity diagnostic tool, 5185-8391



Integrators, Integrator Supplies and Cables

Information generation and presentation have never been more important. Agilent understands that data handling supplies are essential. We provide a convenient way to purchase ink cartridges and integrator supplies at the same time as other laboratory supplies so you never run out at a crucial moment.



Ink cartridge, 5181-1220

Integrator Cartridges and Printheads

Description	Part No.
Ink cartridge, Agilent 3397A, 3396 Series III, 3396A and B, 3395, 3394	5181-1220
Printhead for 3388A and 5880A	19350-60540

Integrator Paper and Supplies

Paper and Supplies for Agilent 3397A, 3396 Series II, and 3396A/B/95/94

Description	Unit	Part No.
Z-fold paper, sequentially numbered, 8.5 x 11 in, 500 sheets/pk, Inkjet	5/pk	5062-3561
Perforated paper, 8.5 x 11 in rolls, Inkjet	4/pk	5181-1219
Perforated paper, sequentially numbered, 8.5 x 11 in rolls, Inkjet	4/pk	5183-2009
Perforated paper, A4 size rolls, Inkjet	4/pk	5181-1255
Replacement paper roll rod		03394-20500
Replacement paper roll brackets	2/pk	03396-40050

Thermal Paper for Agilent 3390/92/93

Description	Unit	Part No.
Thermal printing paper, blue print, 4.209 in (106.9806 mm) wide x 400 ft	4 rolls/pk	5080-8800

Thermal Paper for Agilent 338X/5830/3370

Description	Unit	Part No.
Z-fold paper, black print, 8.5 in wide	8 pk/box	9270-0658

Cables

3396 Series III Cable Sets

Description	Part No.
Series III Integrator General Purpose cables, signal/remote cable pair includes 35900-60630 and 03396-61031	G2108A
INET interface for integrators, provides INET communications and dual-channel output, includes 1 INET cable	G1553A

Cables to Connect 3397A or 3396/95 Series III Integrator

Instrument	Cable Type		
	Analog	Remote	Sample
6890 Series GC (non-INET)	G1530-60570	03396-61010	
5890 GC (non-INET)	35900-60610		
1100/1200 Series LC	35900-60750	03396-61010	03396-60560
General Purpose	35900-60630	03394-60540	

Cables to Connect 3394/95A and 3396A/B Integrator

Instrument	Cable Type	
	Analog	Remote
6890 Series GC	G1530-60570	
	03396-61020	03396-61010
5890 GC	35900-60610	
General Purpose	35900-60630	
	35900-60900	35900-60920

HPIB and GPIB Cables

Description	Part No.
PCI GPIB Card for Win95/98/NT (82350A/B)	G1680-63715
HPIB Cable 2 m (10833B)	10833B-2310
General Purpose Cable GPIO, open end	G1103-61611
HPIB Cable, 8 m (10833G)	10833G-2310
Cable, 6890 to PC 9F/9F RS232	G1530-60600
Crossover Ethertwist Cable, 10 ft	5183-4649
Adapter, extends GPIB connector (10834A)	10834A-2310

Instrument Interface Cables

Description	Part No.
Signal cable, general purpose analog output cable assembly, spade lugs/6 pins	G1530-60560
External event control, cable, 8 pins/spade lugs	G1530-60590
Remote start cable for general use with lug	35900-60670
6890 to PC via RS 232-C, 9 female/25 male user card cable	G1530-60610
General purpose binary-coded decimals cable with spade lugs	G1530-60630
Automatic liquid sampler; remote start/stop cable, 2 m 9 male/9 female	G1530-60930
HPIL cable, 5 m	82167-60003
Remote Y Cable, G1512/5890A to 3396C	G1512-60530
Remote Cable to 5890	35900-60700



Product Index

CTC Autosampler Supplies

CombiPAL Headspace Syringes	87
CombiPAL and GC PAL Liquid Injection Syringes.....	86
HTS and HTC PAL Liquid Injection Crimp Top Micro Vials and Caps.....	87
Syringes.....	88
Valve Loops and Needle Seals.....	89
Sample Trays.....	90
Well Plates	90

Crimping and Decapping Tools

Electronic Crimpers and Decappers.....	34
Manual Crimpers and Decappers.....	35

Electrochemistry

All-in-one Packages	143-144
Chemicals	147
Electrode Recommended Uses	139-140
Electrode Specifications	
Conductivity Probe	142
D6111 Dissolved Oxygen Probe.....	142
Ion Selective	141
ORP8211 Oxidation Reduction Potential Electrode.....	142
R8111 Reference Electrode.....	142
T7111 Automatic Temperature Compensation Probe	142
pH Electrode	140
Electrodes	146
Environmental Test Specifications	135
Meter Specifications	
3200C Conductivity Meter.....	134
3200D Dissolved Oxygen Meter	135
3200I Ion Meter	133
3200M Multi-parameter Analyzer	131-132
3200P pH Meter.....	130
Meters	145
Module Specifications.....	136-137

Fittings

Adapter.....	118-119
Back Ferrules.....	118
Blanking Nut.....	118-119
Bulkhead Unions.....	120-121
Caps	118
Crosses.....	119-120
Elbows	119-120
Fittings Kit.....	121-122
Front Ferrules.....	117-118
Hose Connector	118-119
Nuts	117-118
Nuts, Front and Back Ferrule Sets.....	117-118

Plugs	118
Reducers	121-122
Reducing Unions.....	121
Tees	119
Unions	120-121
Zero Dead Volume Unions.....	120-121

Flow Meters

ADM Flow Meters.....	110
Precision Gas Flow Meter.....	111-112

GC Column Accessories

Capillary Column Installation Kit.....	125
Capillary Column Rinse Kit.....	125
Column Baskets and Hangers.....	126
Fused Silica Tubing Cutters.....	126

GC Installation Kits

Basic Installation	116
Tubing	116
With Gas Purifiers	115
With Tools (no gas purifiers)	116

Gas Purification

Connection Diagrams.....	92-94
Gas Clean Filters	
Accessories.....	99
Connecting Units	98
Fittings.....	99
Replacement Filters	99
Starter Kits.....	98
Gas Cylinder Regulators.....	113-114
Gas Leak Detector.....	111-112
Gas Purifier Selection Guide.....	95
In-Line Gas Traps.....	101
Renewable Gas Purification System.....	100
Universal/External Split Vent Trap	109

In-Line Gas Traps

Big Hydrocarbon Traps (BHT Series).....	103
Big Moisture Traps (BMT Series).....	103
Big Oxygen Traps (BOT Series).....	103
Big Universal Traps	101-102
Combination Traps	
Hydrocarbon/Moisture Traps.....	109
Oxygen/Moisture Traps.....	108
Hydrocarbon Traps.....	106
Indicating Moisture Traps.....	104
Indicating Oxygen Traps.....	105
Oxygen Traps	106

Integrators

Cables.....	149-150
Cartridges.....	148
Paper.....	148

Syringes

Agilent Syringes	
7673/7683 On-Column Autosampler Syringes	68
Blue Line Autosampler Syringes for 7693A ALS	
Advanced Sample Enhancement	65
Fitted Plungers	64-65
PTFE-Tipped Plungers.....	64-65
Gold Standard Autosampler Syringes	
Straight Needle, 23 and 26s Gauge.....	67
Tapered Needle, 23-26s Gauge.....	66
HP 7670/71/72 Autosampler Syringes.....	68
LC Manual Syringes	
Fitted Plungers.....	76
PTFE-Tipped Plungers.....	76
Manual Syringes	
Fitted Plunger, Fixed and Removable Needle	70-71
LC with Fitted Plungers	76
LC with PTFE-Tipped Plungers.....	76
Luer Lok Needles	75
PTFE-Tipped Plunger and Luer Lok	74-75
PTFE-Tipped Plunger, Fixed Needle	73-74
PTFE-Tipped Plunger, Removable Needle.....	72-74
Needle Gauge.....	61
Needle Termination	62
Needle Tip Design	62
CrossLab Syringes	
Autosampler Syringes for Bruker/Varian Systems	79
Autosampler Syringes for CTC Analytics Systems.....	83
Autosampler Syringes for Dionex Systems.....	84
Autosampler Syringes for PerkinElmer Systems.....	80
Autosampler Syringes for Shimadzu Systems.....	81
Autosampler Syringes for Thermo Systems.....	82
Autosampler Syringes for Waters Systems.....	85
Needle Gauge	77-78
Needle Termination	78

Tools

12-Piece File Set	129
20x Magnifier	127
FID Cleaning Kit.....	129
Ferrule Tools	127
General Laboratory Tool Kit.....	123
Hex Keys	124

Injection Port Cleaning Kit.....128
 LC Tool Kits.....123
 Microprobes.....127
 Mirror.....128
 Pliers and Tweezers124
 Screwdrivers123
 Snoop.....128
 Tube Cutters.....124
 Wrenches123

Vials and Accessories

Agilent Vials

Crimp Top
 2 mL Wide Opening Vials.....19
 Caps with 11 mm Septa20
 Convenience Packs.....20
 LC19

General Purpose

Bonded Caps33
 Sample Storage Vial Kits.....33

Headspace

20 mm Caps and Septa.....26
 CombiPAL 18 mm Screw Top Caps
 with Septa27
 CombiPAL Screw Top Vials.....27
 Convenience Packs.....26
 Crimp Top Vials24
 High Performance Septa.....25-26

High Recovery30
 MS Analyzed.....14
 Micro-V.....30
 Microvolume Inserts.....21
 Polypropylene22-23

Screw Top

2 mL Standard Opening (8 mm) Vials31
 2 mL Wide Opening Vials.....15
 4 mL (13 mm) Vials.....32
 Caps for 2 mL Vials.....16
 Convenience Packs.....18
 LC15
 Pre-assembled Packs17
 Screw Cap Pack for 7696 Sample Prep
 Workbench.....16
 Septa for Wide Opening Caps.....16
 Septa Chemical Compatibility10-12

Snap Top

2 mL (11 mm) Vials.....28
 Convenience Packs.....29
 Polyethylene Caps with 11 mm Septa29
 Vial Identification Chart.....13

CrossLab Vials

Crimp Top
 2 mL (11 mm) Vials.....49
 Caps with 11 mm Septa50
 Convenience Packs.....50
 Micro Vials.....51
 Cross Reference List.....58-59

Headspace

Caps41-42

Convenience Packs.....42-43
 Crimp Top Vials40-41
 High Performance Septa.....41-42
 Screw Top Vials.....40-41
 Micro-V.....54
 Microvolume Inserts.....55
 Polypropylene54
 Screw Top
 10 mL (22 mm) Vials.....48
 2 mL Standard Opening (8 mm) Vials45-46
 2 mL Wide Opening (9 mm) Vials43
 2 mL Wide Opening Convenience Packs45
 4 mL (13 mm) Vials.....47
 6 mL (16 mm) Vials.....48
 Caps for 2 mL Vials.....44
 Septa for Wide Opening Caps.....44
 Sealing Mats.....57
 Septa Selection39
 Snap Top
 2 mL (11 mm) Vials.....51
 Caps with 11 mm Septa52
 Convenience Packs.....52
 Storage Vial Convenience Packs53, 55
 Vial Compatibility37
 Vial Identification Chart.....38
 Well Plates57
 Electronic Crimpers and Decappers34
 Manual Crimpers and Decappers35

Part Number Index

0100-0053	117	35900-60630	149	5180-4106	117	5181-8808	67
0100-0057	117	35900-60670	150	5180-4108	117	5181-8809	67
0100-0058	117	35900-60700	150	5180-4109	117, 122	5181-8810	66
0100-0071	118	35900-60750	149	5180-4110	117	5181-8811	67
0100-0073	122	35900-60900	149	5180-4111	117, 122	5181-8813	67
0100-0088	119	35900-60920	149	5180-4113	118	5181-8836	126
0100-0089	119	3700014600	116	5180-4114	118	5181-8866	68
0100-0090	119	420-1000	126	5180-4115	118, 122	5181-8872	21
0100-0091	120	430-1020	127	5180-4116	118	5182-0540	29
0100-0092	120	430-2000	125	5180-4117	118, 122	5182-0541	29
0100-0110	121	430-3000	125	5180-4120	118, 122	5182-0542	29
0100-0111	121	440-1000	128	5180-4121	115-116, 118, 122	5182-0543	19
0100-0118	114, 121	450-1000	128	5180-4124	118, 122	5182-0544	28
0100-0119	114, 121	460-1002	128	5180-4125	118, 122	5182-0545	28
0100-0121	121	480-0003	128	5180-4127	120, 122	5182-0546	28
0100-0124	120	5021-7107	116	5180-4128	120, 122	5182-0547	29
0100-0126	120	5040-4649	16	5180-4129	119, 122	5182-0548	29
0100-0128	120	5040-4667	35	5180-4130	121	5182-0550	29
0100-0132	120	5040-4668	35	5180-4131	121-122	5182-0551	32
0100-0133	120	5040-4669	35	5180-4134	122	5182-0552	20
0100-0161	120	5040-4671	35	5180-4135	122	5182-0553	17
0100-0208	121	5040-4681	16	5180-4143	121	5182-0554	17
0100-0241	121	5040-4682	16	5180-4145	121	5182-0555	17
0100-0420	119	5040-4683	16	5180-4148	119	5182-0556	17
0100-0542	119	5042-1386	90	5180-4149	117	5182-0557	17
0100-0680	119	5042-1388	90	5180-4153	128	5182-0558	17
0100-0782	119	5042-1389	90	5180-4160	115-116, 119, 122	5182-0564	29
0100-0900	120	5042-6454	90	5180-4161	122	5182-0566	29
0100-0969	119	5061-3370	20, 29	5180-4162	123	5182-0567	23
0100-0985	120	5062-3561	148	5180-4196	115-116	5182-0714	15
0100-0996	120	5062-3582	20	5181-1210	20, 29	5182-0715	15
0100-1189	121	5064-8211	124	5181-1211	20	5182-0716	15
0100-1315	118	5067-0205	18	5181-1212	20	5182-0717	16
0100-1316	120	5067-0218	112	5181-1215	20	5182-0718	16
01080-83202	119	5067-0219	112	5181-1216	20	5182-0719	16
03394-20500	148	5067-0220	112	5181-1217	20	5182-0720	16
03394-60540	149	5067-0223	111	5181-1219	148	5182-0721	16
03396-40050	148	5067-0226	24	5181-1220	148	5182-0722	16
03396-60560	149	5067-0227	24	5181-1255	148	5182-0723	16
03396-61010	149	5067-0234	26	5181-1267	66	5182-0724	16
03396-61020	149	5067-0246	32	5181-1270	21	5182-0725	16
0460-1266	114	5067-0247	32	5181-1273	66	5182-0726	16
07673-40180	32	5080-5400	128	5181-1292	117	5182-0727	16
10833B-2310	150	5080-8750	115-117	5181-3319	66	5182-0728	16
10833G-2310	150	5080-8751	117	5181-3321	66	5182-0729	16
10834A-2310	150	5080-8752	117	5181-3354	66	5182-0730	16
1460-1914	126	5080-8753	117	5181-3356	66	5182-0731	16
19091-80060	126	5080-8800	148	5181-3358	66-67	5182-0732	18
19199M	116	5180-0805	87	5181-3360	66	5182-0733	18
19199N	98, 115	5180-0806	87	5181-3361	66	5182-0734	18
19251-80680	127	5180-0841	87	5181-3365	66	5182-0735	18
19350-60540	148	5180-0842	87	5181-3375	19	5182-0736	18
220-1170	110	5180-0844	87	5181-3376	19	5182-0737	18
220-1171-E	110	5180-4102	117	5181-3377	21	5182-0830	67
220-1171-U	110	5180-4103	117, 122	5181-3400	20	5182-0831	68
2869463500	117	5180-4104	117	5181-8801	20	5182-0832	66, 68
35900-60610	149	5180-4105	117, 122	5181-8806	67	5182-0833	68

PART NUMBER INDEX

5182-0834.....	67	5183-2089.....	31	5183-4511.....	29	5188-6477.....	89
5182-0835.....	66	5183-2090.....	31	5183-4518.....	31	5188-6478.....	89
5182-0836.....	68	5183-4301.....	33	5183-4620.....	126	5188-6479.....	90
5182-0837.....	24	5183-4302.....	33	5183-4621.....	126	5188-6485.....	88
5182-0838.....	24	5183-4303.....	33	5183-4641.....	114	5188-6486.....	89
5182-0839.....	26	5183-4304.....	33	5183-4642.....	114	5188-6487.....	89
5182-0840.....	26	5183-4305.....	33	5183-4643.....	114	5188-6488.....	89
5182-0864.....	17	5183-4306.....	33	5183-4644.....	114	5188-6489.....	89
5182-0865.....	17	5183-4307.....	33	5183-4645.....	114	5188-6490.....	89
5182-0866.....	17	5183-4308.....	33	5183-4649.....	150	5188-6491.....	89
5182-0867.....	18	5183-4311.....	33	5183-4728.....	67	5188-6492.....	89
5182-0868.....	18	5183-4312.....	33	5183-4729.....	67	5188-6535.....	15
5182-0869.....	18	5183-4313.....	33	5183-4730.....	67	5188-6536.....	15
5182-0871.....	20	5183-4314.....	33	5184-3550.....	30	5188-6537.....	27
5182-0875.....	67	5183-4321.....	33	5184-3551.....	30	5188-6538.....	27
5182-3453.....	116	5183-4322.....	33	5184-3552.....	30	5188-6572.....	19
5182-3454.....	30	5183-4323.....	33	5184-3554.....	30	5188-6593.....	28
5182-3457.....	29	5183-4324.....	33	5184-3555.....	30	5188-6594.....	28
5182-3458.....	29	5183-4331.....	33	5184-3556.....	30	5188-6596.....	86
5182-3459.....	29	5183-4332.....	33	5185-5820.....	16	5190-0464.....	70
5182-3465.....	116, 123	5183-4333.....	33	5185-5823.....	16	5190-0533.....	143-144, 147
5182-3466.....	116, 123	5183-4334.....	33	5185-5824.....	16	5190-0534.....	143-144, 147
5182-9201.....	105	5183-4428.....	31	5185-5829.....	16	5190-0535.....	147
5182-9202.....	105	5183-4429.....	31	5185-5838.....	16	5190-0536.....	147
5182-9211.....	104	5183-4432.....	31	5185-5861.....	16	5190-0537.....	147
5182-9401.....	105	5183-4433.....	31	5185-5862.....	16	5190-0538.....	147
5182-9402.....	105	5183-4436.....	31	5185-5863.....	16	5190-0539.....	147
5182-9411.....	104	5183-4437.....	31	5185-5864.....	16	5190-0540.....	147
5182-9622.....	68	5183-4438.....	31	5185-5865.....	16	5190-0543.....	147
5182-9626.....	68	5183-4442.....	31	5185-8389.....	147	5190-0544.....	147
5182-9734.....	68	5183-4448.....	32	5185-8390.....	147	5190-0545.....	147
5182-9799.....	68	5183-4450.....	32	5185-8391.....	147	5190-0546.....	147
5183-0314.....	66	5183-4459.....	32	5188-2753.....	27	5190-0547.....	147
5183-0316.....	67	5183-4460.....	32	5188-2758.....	15	5190-0548.....	147
5183-0318.....	67	5183-4461.....	32	5188-2759.....	27	5190-1414.....	100
5183-1941.....	114	5183-4464.....	32	5188-2788.....	23	5190-1442.....	124
5183-2009.....	148	5183-4474.....	24	5188-5246.....	67	5190-1457.....	75
5183-2030.....	30	5183-4475.....	24	5188-5247.....	67	5190-1460.....	70
5183-2042.....	66	5183-4477.....	26	5188-5369.....	15	5190-1461.....	70
5183-2058.....	67	5183-4478.....	26	5188-5370.....	67	5190-1462.....	70
5183-2067.....	15	5183-4479.....	26	5188-5371.....	67	5190-1463.....	70
5183-2068.....	15	5183-4480.....	26	5188-5386.....	20	5190-1464.....	70
5183-2069.....	15	5183-4487.....	87	5188-5390.....	23	5190-1465.....	70
5183-2070.....	15	5183-4491.....	19	5188-5392.....	27	5190-1466.....	70
5183-2071.....	15	5183-4492.....	19	5188-5395.....	88	5190-1467.....	70
5183-2072.....	15	5183-4493.....	19	5188-6457.....	89	5190-1468.....	70
5183-2073.....	30	5183-4494.....	19	5188-6458.....	89	5190-1469.....	70
5183-2074.....	16	5183-4495.....	19	5188-6460.....	89	5190-1470.....	70
5183-2075.....	16	5183-4496.....	19	5188-6461.....	89	5190-1471.....	70
5183-2076.....	16	5183-4497.....	30	5188-6462.....	89	5190-1472.....	70
5183-2077.....	16	5183-4498.....	20	5188-6463.....	89	5190-1473.....	70
5183-2078.....	16	5183-4499.....	20	5188-6464.....	89	5190-1474.....	70
5183-2079.....	18	5183-4500.....	20	5188-6465.....	89	5190-1475.....	70
5183-2080.....	18	5183-4504.....	28	5188-6466.....	89	5190-1476.....	70
5183-2081.....	18	5183-4505.....	28	5188-6467.....	89	5190-1477.....	70
5183-2082.....	17	5183-4506.....	28	5188-6468.....	89	5190-1478.....	70
5183-2083.....	17	5183-4507.....	28	5188-6469.....	89	5190-1479.....	70
5183-2085.....	21	5183-4508.....	28	5188-6470.....	89	5190-1480.....	76
5183-2086.....	21	5183-4509.....	28	5188-6471.....	87	5190-1481.....	70
5183-2088.....	31	5183-4510.....	30	5188-6476.....	89	5190-1482.....	70

5190-1483.....	71	5190-1543.....	75	5190-3995.....	146	8004-0005.....	79
5190-1484.....	76	5190-1544.....	75	5190-3996.....	143, 146	8004-0006.....	79
5190-1485.....	76	5190-1545.....	75	5190-3997.....	144, 146	8004-0007.....	79
5190-1486.....	76	5190-1546.....	75	5190-3998.....	143-144, 146	8005-0414.....	85
5190-1487.....	71	5190-1547.....	75	5190-3999.....	146	8005-0416.....	85
5190-1488.....	71	5190-1548.....	75	5190-4002.....	144, 146	8005-0417.....	85
5190-1489.....	71	5190-1549.....	75	5190-4003.....	146	8005-0418.....	85
5190-1490.....	73	5190-1550.....	75	5190-4004.....	146	8005-0419.....	85
5190-1491.....	72	5190-1558.....	73, 76	5190-4005.....	146	8005-0420.....	85
5190-1492.....	76	5190-1559.....	72	5190-4048.....	87	8010-0001.....	49
5190-1493.....	71	5190-1560.....	72-73, 76	5190-4061.....	34	8010-0002.....	49
5190-1494.....	76	5190-1561.....	72-74, 76	5190-4062.....	34	8010-0003.....	49
5190-1495.....	71	5190-1562.....	72-74, 76	5190-4063.....	34	8010-0004.....	54
5190-1496.....	71-72	5190-1563.....	72-74	5190-4064.....	34	8010-0005.....	54
5190-1497.....	73	5190-1564.....	72-74, 76	5190-4065.....	34	8010-0006.....	49
5190-1498.....	72	5190-1565.....	73-75	5190-4066.....	34	8010-0007.....	49
5190-1499.....	76	5190-1571.....	76	5190-4067.....	34	8010-0008.....	43
5190-1500.....	71	5190-1572.....	73-75	5965-0027.....	124	8010-0009.....	43
5190-1501.....	76	5190-1573.....	73-75	5965-0028.....	124	8010-0010.....	45
5190-1502.....	71	5190-1574.....	73-75	707-0027.....	128	8010-0011.....	45
5190-1503.....	73	5190-1575.....	75	7157-0210.....	116	8010-0012.....	45
5190-1504.....	72	5190-1576.....	75	8001-0001.....	81	8010-0013.....	45
5190-1505.....	76	5190-1577.....	75	8001-0002.....	81	8010-0014.....	43
5190-1506.....	74	5190-1581.....	73	8001-0003.....	81	8010-0015.....	43
5190-1507.....	71	5190-1599.....	16	8001-0004.....	81	8010-0016.....	43
5190-1508.....	76	5190-2238.....	24	8001-0005.....	81	8010-0017.....	43
5190-1509.....	71	5190-2239.....	24	8001-0006.....	81	8010-0018.....	54
5190-1510.....	73	5190-2240.....	29	8001-0007.....	81	8010-0019.....	54
5190-1511.....	72	5190-2241.....	20	8001-0401.....	81	8010-0020.....	47
5190-1512.....	76	5190-2242.....	23	8001-0402.....	81	8010-0021.....	47
5190-1513.....	74	5190-2243.....	23	8001-0404.....	81	8010-0022.....	48
5190-1514.....	71	5190-2257.....	26	8002-0001.....	82	8010-0023.....	51
5190-1515.....	76	5190-2258.....	26	8002-0002.....	82	8010-0024.....	51
5190-1516.....	71	5190-2277.....	14	8002-0003.....	82-83	8010-0025.....	51
5190-1517.....	73	5190-2278.....	14	8002-0004.....	82-83	8010-0026.....	51
5190-1518.....	72	5190-2279.....	14	8002-0005.....	82-83	8010-0027.....	54
5190-1519.....	74	5190-2280.....	14	8002-0401.....	84	8010-0028.....	54
5190-1520.....	76	5190-2281.....	14	8002-0402.....	84	8010-0029.....	40
5190-1521.....	71	5190-2282.....	14	8002-0403.....	84	8010-0030.....	40
5190-1522.....	76	5190-2283.....	14	8002-0404.....	84	8010-0031.....	40
5190-1523.....	73	5190-2285.....	24	8002-0405.....	84	8010-0032.....	40
5190-1524.....	71	5190-2286.....	24	8002-0406.....	84	8010-0033.....	40
5190-1525.....	72	5190-2287.....	24	8002-0407.....	84	8010-0034.....	40
5190-1526.....	76	5190-2288.....	24	8002-0408.....	84	8010-0035.....	40
5190-1527.....	74	5190-3155.....	23	8002-0412.....	84	8010-0036.....	40
5190-1528.....	74	5190-3188.....	34	8002-0413.....	84	8010-0038.....	40
5190-1529.....	73	5190-3189.....	34	8002-0414.....	84	8010-0040.....	40
5190-1530.....	75	5190-3190.....	34	8002-0415.....	84	8010-0042.....	40
5190-1531.....	75	5190-3191.....	34	8003-0001.....	80	8010-0044.....	40
5190-1532.....	74	5190-3192.....	34	8003-0002.....	80	8010-0045.....	50
5190-1533.....	73	5190-3193.....	67	8003-0003.....	80	8010-0046.....	50
5190-1534.....	75	5190-3984.....	86	8003-0004.....	80	8010-0047.....	50
5190-1535.....	75	5190-3985.....	86	8003-0005.....	80	8010-0048.....	50
5190-1536.....	74	5190-3988.....	143-144, 146	8003-0006.....	80	8010-0049.....	50
5190-1537.....	73	5190-3989.....	146	8003-0007.....	80	8010-0050.....	50
5190-1538.....	73	5190-3990.....	143, 146	8003-0008.....	80	8010-0051.....	50
5190-1539.....	75	5190-3991.....	146	8004-0001.....	79	8010-0052.....	50
5190-1540.....	75	5190-3992.....	146	8004-0002.....	79	8010-0053.....	50
5190-1541.....	74	5190-3993.....	146	8004-0003.....	79	8010-0054.....	46
5190-1542.....	73	5190-3994.....	143-144, 146	8004-0004.....	79	8010-0055.....	46

PART NUMBER INDEX

8010-0056.....	46	8010-0120.....	42	8010-0359.....	83	8010-0558.....	55
8010-0057.....	46	8010-0121.....	42	8010-0360.....	83	8010-0559.....	47
8010-0058.....	46	8010-0122.....	42	8010-0361.....	83	8010-0560.....	47
8010-0059.....	46	8010-0124.....	55	8010-0362.....	83	8010-0561.....	47
8010-0060.....	46	8010-0125.....	55	8010-0363.....	83	8010-0562.....	47
8010-0061.....	46	8010-0126.....	55	8010-0364.....	83	8010-0563.....	48
8010-0062.....	46	8010-0131.....	55	8010-0365.....	83	8010-0564.....	48
8010-0063.....	46	8010-0132.....	55	8010-0366.....	83	8010-0565.....	48
8010-0064.....	46	8010-0136.....	55	8010-0367.....	82-83	8010-0566.....	50
8010-0065.....	46	8010-0139.....	42	8010-0368.....	82	8010-0567.....	50
8010-0066.....	46	8010-0140.....	42	8010-0411.....	52	8010-0568.....	50
8010-0067.....	46	8010-0141.....	46	8010-0412.....	42	8010-0569.....	50
8010-0068.....	46	8010-0142.....	46	8010-0413.....	42	8010-0574.....	55
8010-0069.....	46	8010-0143.....	42	8010-0414.....	45	8010-0575.....	55
8010-0070.....	46	8010-0144.....	42	8010-0415.....	45	8010-0577.....	57
8010-0071.....	46	8010-0151.....	41	8010-0416.....	53	8010-0578.....	57
8010-0072.....	46	8010-0152.....	41	8010-0417.....	42	8010-0582.....	50
8010-0073.....	46	8010-0153.....	51	8010-0418.....	42	82167-60003.....	150
8010-0074.....	44	8010-0154.....	51	8010-0420.....	42	8710-0004.....	124
8010-0075.....	44	8010-0155.....	51	8010-0422.....	53	8710-0007.....	124
8010-0076.....	44	8010-0158.....	54	8010-0423.....	53	8710-0018.....	124
8010-0077.....	44	8010-0159.....	54	8010-0424.....	42	8710-0510.....	116, 123
8010-0078.....	44	8010-0160.....	54	8010-0425.....	45	8710-0641.....	124
8010-0079.....	44	8010-0161.....	54	8010-0426.....	45	8710-0803.....	116, 123
8010-0080.....	44	8010-0162.....	54	8010-0427.....	45	8710-0806.....	116, 123
8010-0081.....	44	8010-0165.....	42	8010-0428.....	42	8710-0899.....	123
8010-0082.....	44	8010-0166.....	46	8010-0429.....	42	8710-0900.....	123
8010-0083.....	44	8010-0170.....	49	8010-0430.....	53	8710-0972.....	116, 123
8010-0084.....	44	8010-0172.....	49	8010-0441.....	85	8710-1217.....	116
8010-0085.....	44	8010-0175.....	43	8010-0442.....	85	8710-1534.....	123
8010-0086.....	44	8010-0176.....	43	8010-0443.....	85	8710-1707.....	124
8010-0087.....	44	8010-0177.....	51	8010-0444.....	85	8710-1708.....	124
8010-0088.....	44	8010-0178.....	51	8010-0445.....	85	8710-1709.....	115-116, 124
8010-0089.....	44	8010-0179.....	40	8010-0446.....	85	8710-1712.....	123
8010-0091.....	44	8010-0180.....	40	8010-0448.....	85	8710-1841.....	123
8010-0092.....	44	8010-0181.....	50	8010-0455.....	85	8710-1924.....	123
8010-0093.....	44	8010-0182.....	50	8010-0460.....	85	8710-1930.....	124
8010-0094.....	44	8010-0183.....	50	8010-0467.....	85	8710-1931.....	124
8010-0095.....	47	8010-0186.....	44	8010-0468.....	85	8710-2392.....	124
8010-0096.....	47	8010-0187.....	44	8010-0532.....	57	8710-2393.....	124
8010-0098.....	47	8010-0188.....	44	8010-0533.....	57	8710-2394.....	124
8010-0099.....	47	8010-0189.....	52	8010-0534.....	57	8710-2411.....	124
8010-0100.....	48	8010-0190.....	52	8010-0535.....	57	8710-2412.....	124
8010-0101.....	48	8010-0191.....	42	8010-0536.....	57	8720-0010.....	123
8010-0102.....	48	8010-0192.....	42	8010-0537.....	57	8720-0025.....	123
8010-0103.....	52	8010-0193.....	54	8010-0538.....	57	907-0056.....	110
8010-0104.....	52	8010-0194.....	54	8010-0539.....	57	9270-0658.....	148
8010-0105.....	52	8010-0195.....	50	8010-0540.....	57	9300-0311.....	115-116, 128
8010-0106.....	52	8010-0196.....	50	8010-0541.....	57	9301-0713.....	67
8010-0107.....	52	8010-0198.....	45	8010-0542.....	45	9301-0714.....	67
8010-0108.....	52	8010-0199.....	45	8010-0543.....	45	9301-0718.....	26
8010-0109.....	52	8010-0200.....	52	8010-0545.....	45	9301-0719.....	26
8010-0110.....	52	8010-0351.....	79, 82-83	8010-0546.....	45	9301-0721.....	26
8010-0111.....	52	8010-0352.....	82-83	8010-0547.....	45	9301-0723.....	32
8010-0112.....	52	8010-0353.....	82-83	8010-0548.....	45	9301-0725.....	67
8010-0113.....	52	8010-0354.....	82-83	8010-0553.....	47	9301-0891.....	67
8010-0115.....	52	8010-0355.....	82-83	8010-0554.....	47	9301-0892.....	67
8010-0116.....	42	8010-0356.....	83	8010-0555.....	47	9301-0976.....	26
8010-0117.....	42	8010-0357.....	83	8010-0556.....	47	9301-0977.....	23
8010-0119.....	42	8010-0358.....	83	8010-0557.....	47	9301-0978.....	23

9301-0985	129	G1099-20030	127	G4513-80201	64	HT3-2	106
9301-1031	32	G1103-61611	150	G4513-80202	64	HT3-4	106
9301-1130	31	G1512-60530	150	G4513-80203	65	MC-1	106, 108-109
9301-1377	15	G1530-60560	150	G4513-80204	64	OT1-2	106
9301-1378	15	G1530-60570	149	G4513-80205	64	OT1-4	106
9301-1379	15	G1530-60590	150	G4513-80206	64	OT3-2	108
9301-1387	21	G1530-60600	150	G4513-80208	65	OT3-4	108
9301-1388	19	G1530-60610	150	G4513-80209	64	RDT-1020	109, 115
9301-1419	19	G1530-60630	150	G4513-80210	65	RDT-1023	109
9301-1425	19	G1530-60930	150	G4513-80211	64	RFT-2500	127
AL30509	116	G1530-61580	126	G4513-80212	64	RFT-5300	127
AL45734	116	G1553A	149	G4513-80213	64	RMP-5005	127
BHT-2	103	G1680-63715	150	G4513-80215	64	RMSH-2	102
BHT-4	103	G1999-80410	109	G4513-80216	64	RMSH-4	102
BMT-2	103	G2108A	149	G4513-80218	64	RMSHY-2	102
BMT-4	103	G2630-80800	126	G4513-80219	65	RMSHY-4	102
BOT-2	103	G3388B	112	G4513-80220	65	RMSN-2	102
CP17969	99	G3440-60003	100	G4513-80221	65	RMSN-4	102
CP17970	99	G3440-60004	100	G4513-80222	65	RSF-1200	129
CP17971	99	G3440-69003	100	G4513-80223	65	SWB1021	117
CP17971P	99	G3440-80007	100	G4513-80224	64	SWSS20074	121
CP17972	99	G4200-80101	87-88	G4513-80225	64-65	SWSS4031	117
CP17973	99	G4200-80102	86, 88	G4513-80226	64	SWSS4041	118
CP17976	98	G4200-80103	88	G4513-80227	65	UMC-5-2	102-103
CP17977	98	G4200-80104	86, 88	G4513-80228	65		
CP17978	98	G4200-80105	86, 88	G4513-80229	64		
CP17982	98	G4200-80106	86, 88	G4513-80233	65		
CP17983	98	G4200-80107	87-88	G4513-80234	64		
CP17984	98	G4200-80108	87-88	G4513-80235	64		
CP17985	98	G4200-80111	88	G4513-80236	64-65		
CP4013	116	G4200-80112	88	G4513-80239	64		
CP4024	116	G4200-80113	88	G4513-80240	64		
CP4025	116	G4200-80114	88	G4513-80241	65		
CP4026	116	G4200-80115	88	G4513-80242	64		
CP4030	116	G4200-80116	88	G4513-80243	64		
CP4032	116	G4200-80117	88	G4513-80244	64		
CP736520	98	G4200-80118	88	G6500-80100	90		
CP736530	98, 115	G4200-80119	88	G6500-80101	90		
CP738406	98	G4203-68708	123	G6500-80102	88		
CP738407	98	G4296-68715	123	G6500-80103	88		
CP738408	98	G4383-40000	147	G6500-80104	88		
CP741648	121	G4383A	143, 145	G6500-80105	88		
CP7978	99	G4384A	143, 145	G6500-80106	88		
CP7980	98	G4385A	144-145	G6500-80107	87		
CP7980P4	98	G4386A	144-145	G6500-80109	87		
CP7980P6	98	G4387A	144-145	G6500-80111	87		
CP7981	99	G4388-27000	147	G6500-80113	86		
CP7983	99	G4388A	145	G6500-80114	86		
CP7986	99	G4389A	143-145	G6500-80115	86		
CP7986SS	99	G4391A	143	G6500-80116	86		
CP7986SS6	99	G4392A	143	G6500-80117	86		
CP7987	99	G4393A	143	G6500-80118	86		
CP7988	98	G4394A	143	G6500-80119	86		
CP7988P3	98	G4395A	144	G6500-80120	86		
CP7988P8	98	G4396A	144	G6500-80121	90		
CP7989	98	G4397A	144	G6500-80122	90		
CP7995	98	G4398A	144	HMT200-2	109		
CP82117	99	G4513-60560	65	HMT200-4	109		
CP82117SS	99	G4513-60561	65	HT200-2	106		
CP82117SS3	99	G4513-80200	64	HT200-4	106		

Ordering Information

Easy Ordering Terms and Conditions

Discounts and Delivery

Agilent Technologies specializes in fast delivery. In the US, if you call before 2 PM EST, we will ship your order that day. You may also request overnight express delivery before 6 PM EST and you will have your order the next day. Volume discounts on a variety of individual products are offered when the entire quantity is shipped to one address at one time.

A shipping and handling fee will be added to your order unless the purchase is over \$2000 US for orders place online or over \$4000 for orders place via phone. Special shipping (i.e., overnight in the US) is available in most regions at an additional cost.

Agilent is required to collect all state and local sales taxes unless the buyer's tax-exempt certificate is on file with Agilent Technologies. Please be prepared to provide a copy if it is not on file, when placing your order.

Please check with your Agilent Customer Service Representative, local Authorized Distributor, or the Agilent website for current prices, special offers, promotions and discounts when placing your order.

Satisfaction Guaranteed

If you are not satisfied with your Agilent product within the first 60 days, you may return your purchase in its original condition for a full refund or credit. A return policy statement is included in every Agilent shipment and posted under Product Information on the website. In the US and Canada, please call for a Return Authorization form and return instructions at **1-800-227-9770**. If your Agilent product was purchased from a distributor, please contact the distributor.

Shipping Damages

If items are damaged in transit, please follow the instructions below:

- If a shipment is visibly damaged upon arrival, do not accept it until the person making the delivery has endorsed the bill of lading with statement for the extent of the damage.
- If any damage is found after unpacking, retain all cartons and inner packaging and immediately request an inspection from the carrier.
- Notify the Agilent Customer Contact Center at **1-800-227-9770** about the damaged shipment so that we can make the appropriate sales adjustment and/or provide you with return instructions (Sales order number, product number and quantity damaged will be needed).

Easy Ways To Order

- Phone: **1-800-227-9770** (option 1, 1) in the US and Canada – Mon-Fri, 8AM to 8PM EST
- Fax: **1-302-633-8901** in the US
- Email: **cag_sales-na@agilent.com** in the US and Canada
- Online: **www.agilent.com/chem** in the US and Canada

Payment Options

- In the US, Visa, MasterCard, Discover and American Express are accepted with a minimum order of \$20 (not applicable in all countries).
- Email ePay@agilent.com to make an electronic payment using the ACH/EFT (Automated Clearing House/Electronic Funds Transfer) method.
- Establish a charge account through your Agilent Customer Service Representative or Your Local Agilent sales office. An account number will be assigned to you for charging your purchases. Payment terms are net 30 days from the invoice date. All orders are subject to credit approval.

We will be happy to supply a price quote via, phone, email or fax if you need it in writing.

Warranties

All Agilent Technologies products in this catalog are designed and manufactured to stringent standards under the Agilent quality system registered to ISO 9001. At Agilent, we back every product with a 90-day warranty and a money-back guarantee. If Agilent receives notice of defects during the warranty period, Agilent shall, at its option, either repair or replace products which prove to be defective. If Agilent is unable, within a reasonable time, to repair or replace any product to a condition as warranted, the buyer shall be entitled to a refund of the purchase price upon return of the product to Agilent. The warranty period for each product begins on the day of shipment.

This warranty shall not apply to any defect, failure, or damage caused by improper use or improper or inadequate maintenance or care. This warranty is exclusive and no other warranty, whether written or oral, is expressed or implied. Agilent specifically disclaims the implied warranties of merchantability and fitness for particular purposes. The remedies provided herein are the buyer's sole and exclusive remedies. In no event shall Agilent be liable for direct, indirect, special, incidental, or consequential damages (including loss of profits) whether based on contract, tort, or any other legal theory.

Agilent Technologies Order Form

Outside the U.S. and Canada, please contact your local Agilent office or Authorized Distributor when ordering.



Order Date	Purchase Order or Credit Card Number & Expiration	Taxable Y or N?	Yes	No
Name:		If No, please provide Certificate #		
Title:				
Phone:		Fax:		
Company:		Email:		
	Shipping Address	Billing Address		
Company:				
Street:				
Room/Bldg/Dept:				
City:				
State/Province/Country:				
Zip/Postal Code:				
Deliver to:				
Part Number	Description	Quantity	Price	Total Cost
Special Instructions:		Subtotal:		
		Tax:		
		Total:		
<p>For Assistance: Please call the Agilent Technologies Customer Contact Center at 1-800-227-9770 (U.S. and Canada) Email Node: cag_sales-na@agilent.com Fax Number: 302-633-8901 U.S. and Canada Note: 1. All pricing, tax, discount, and availability information is subject to verification by Agilent Technologies. 2. Shipping and handling is free for orders over \$2000 US.</p>				

NEW FORMAT. SAME ESSENTIAL RESOURCE.

The Essential Chromatography and Spectroscopy Catalog is now available in a boxed set to help you easily find the products and information you need. Each catalog is your essential resource for:

- Product photos and ordering information
- Troubleshooting tips
- Selection guides and applications
- Maintenance schedules
- Compatibility charts

Your boxed set includes comprehensive information for Agilent's entire portfolio of Chromatography and Spectroscopy columns and supplies in the following catalogs:

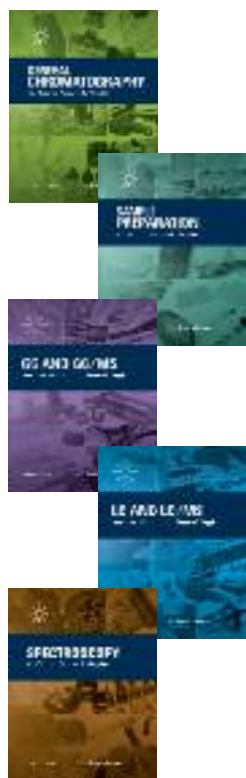

General Chromatography Supplies – Minimize contamination and ensure accurate, reproducible results with our selection of vials, syringes, gas purification systems, fittings and tools, and electrochemistry meters.

Sample Preparation Products for Chromatography – Reliably extract and concentrate samples from complex matrices with Bond Elut SPE cartridges, pre-packaged QuEChERS kits, sample filtration products, dried matrix spotting cards and pre-measured TOXI-TUBES.

GC and GC/MS – Achieve excellent, reproducible performance for difficult samples with ultra inert solutions for GC, premium inlet supplies, Agilent J&W GC columns and standards, and more.

LC and LC/MS, including CE and CE/MS – Maximize system performance and produce quality results time after time with LC capillaries, lamps, and the entire family of ZORBAX LC columns for small molecules, biomolecules and GPC/SEC.

Spectroscopy – Satisfy your growing demand to screen large numbers of samples, faster, with supplies and standards for Atomic Absorption, ICP-OES, ICP-MS, MP-AES and Molecular Spectroscopy.

For more information and to request additional catalogs, please visit www.agilent.com/chem/catalog



Special Offers from Agilent

You don't have to look far to find valuable offers that feature high-performance columns and supplies, accessories, and more.

Just go to www.agilent.com/chem/specialoffers to find out about our latest offers. And be sure to check back often, because we'll update this page throughout the year!

For more details about these offers, contact your local Agilent office or Authorized Agilent Distributor.



For more information

Buy online:

www.agilent.com/chem/store

Contact us:

www.agilent.com/chem/contactus

This information is subject to change without notice.

© Agilent Technologies, Inc. 2012

Printed in Canada October 31, 2012

5991-1056EN



Scan the QR code
with your smartphone
for more information



The Measure of Confidence



Agilent Technologies